

HSN HYDRAULIK

SERVICE NORD



VERBINDUNGSTECHNIK FÜR NIEDERDRUCK
CONNECTING TECHNOLOGY FOR LOW PRESSURE

Metrische Gewindeanschlüsse metric thread connections

Schl.-Nr. key no.	Gewinde thread	AD	ID	Rohranschluss pipe connection		
keg. con.	zyl. cyl.	mm	mm	LL	L	S
19	M 6X1	6,00	4,92			
20	M 8X1	8,00	6,92	4		
	M 10X1	10,00	8,92	5;6		
	M 12X1	12,00	10,92	8		
21	M 10X1	10,00	8,92			
22	M 12X1,5	12,00	10,38		6	
23	M 14X1,5	14,00	12,38		8	6
24	M 16X1,5	16,00	14,38		10	8
25	M 18X1,5	18,00	16,38		12	10
26	M 20X1,5	20,00	18,38			12
27	M 22X1,5	22,00	20,38		15	14
28	M 24X1,5	24,00	22,38			16
29	M 26X1,5	26,00	24,38		18	
	M 27X2	27,00	24,84			
	M 30X1,5	30,00	28,38			
	M 30X2	30,00	27,84		22	20
	M 33X2	33,00	30,84			
	M 36X2	36,00	33,84		28	25
	M 38X1,5	38,00	36,38			
	M 42X2	42,00	39,84			30
	M 45X1,5	45,00	43,38			
	M 45X2	45,00	42,84		35	
	M 48X2	48,00	45,84			
	M 52X1,5	52,00	50,38			
	M 52X2	52,00	49,84		42	38
	M 54X2	54,00	51,84			
	M 58X2	58,00	55,84			
	M 65X2	65,00	62,84			
	M 78X2	78,00	75,84			
	M 90X2	90,00	87,84			
	M 100X2	100,00	97,84			
	M 110X2	110,00	107,84			
	M 120X2	120,00	117,84			

Zur Bestimmung des Gewindeanschlusses wird zunächst entweder der Außendurchmesser des Außengewindes (AD) oder der Innendurchmesser des Innengewindes (ID) gemessen. Nachdem die Steigung bei metrischem Gewinde oder die Gangzahl bei Zollgewinde festgestellt ist, kann der Anschluss aus den Tabellen ausgesucht werden.

To define the thread connection at first measure the outside diameter of external thread (AD) or the inner diameter of the internal thread (ID). After the definition of the flank lead at metric threads or the number of windings at inch threads the connection can be selected out of the charts.

NPT-Gewindeanschlüsse NPT-thread connections

Schl.-Nr. key no.	NPT Gewinde NPT thread	Gangzahl no. of threads	AD	ID
			mm	mm
81	1/8"	27	9,70	8,60
82	1/4"	18	13,10	11,30
83	3/8"	18	16,30	15,10
84	1/2"	14	20,20	18,60
85	3/4"	14	25,50	24,10
86	1"	11,5	32,20	30,20
87	1-1/4"	11,5	41,00	38,90
88	1-1/2"	11,5	47,00	44,90
89	2"	11,5	58,90	56,70

Schneidringanschluss cutting ring connection

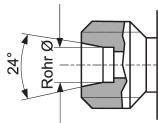

Dichtkegelanschluss sealing cone connection

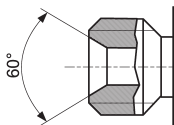

ORFS Flachdichtung mit O-ring flat sealing with O-ring

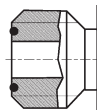

J.I.C.

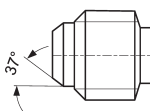

S.A.E.

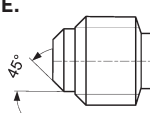

Amerikanische Gewindeanschlüsse american thread connections

Schl.-Nr. key no.	UN Gewinde UN thread	AD	ID	Bemerkung comment
ORS	UNF	mm	mm	
	5/16-24 UN	7,94	7,15	JIC
	3/8-24 UNF	9,52	8,60	JIC
41	7/16-20 UNF	11,07	10,00	JIC + SAE
42	1/2-20 UNF	12,70	11,60	JIC + SAE
91	9/16-18 UNF	14,25	13,00	JIC + SAE
71	5/8-18 UNF	15,85	14,70	SAE
92	11/16-16 UN	17,40	15,40	ORS
44	3/4-16 UNF	19,00	17,60	JIC + SAE
93	13/16-16 UN	20,50	18,60	ORS
45	7/8-14 UNF	22,17	20,50	JIC + SAE
94	1-14 UNS	25,30	23,10	ORS
46	1 1/16-12 UN	26,95	25,00	JIC
72	1 1/16-14 UN	26,95	25,30	SAE
95	1 3/16-12 UN	30,10	27,50	JIC + SAE
47	1 5/16 UN	33,30	31,30	JIC
	1 5/16-14 UNS	33,30	31,60	PTT
96	1 7/16-12	36,40	33,80	ORS
48	1 5/8-12 UN	41,22	39,20	JIC
	1 5/8-14 UNS	41,22	39,50	PTT
97	1 11/16-12 UN	42,80	40,20	ORS
49	1 7/8-12 UNS	47,57	45,60	JIC
	1 7/8-14 UNS	47,57	45,90	PTT
98	2-12 UN	50,70	48,10	ORS
50	2 1/2-12 UN	63,45	61,50	JIC + SAE
	3-12 UN	76,20	74,30	JIC
	3 1/2-12 UN	88,90	87,00	JIC

Amerikanisches Gewinde hat einen Flankenwinkel von 60° und wird mit „Durchmesser-Gangzahl“ bezeichnet, zum Beispiel 1/2"-20. Die Buchstaben UN bezeichnen es als amerikanisches Normgewinde, F=Feingewinde, EF=extra feines und S=Spezialgewinde. Der Begriff SIZE drückt die Nennweite in 1/16" aus, z.B. SIZE-16 = 1" oder SIZE-8 = 1/2".

American thread has a flank angle of 60° and is termed as "diameter number of windings", for example 1/2"-20. The letters UN term it as american standard thread, F=fine thread, EF=extra fine thread and S=special thread. The notion SIZE phrases the nominal size 1/16", e.g. SIZE-16 = 1" or SIZE-8 = 1/2".

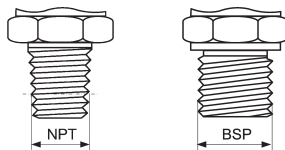

BSP-Gewindeanschlüsse BSP-thread connections

Schl.-Nr. key no.	BSP Gewinde BSP thread	Gangzahl no. of threads	AD	ID
keg. con.	zyl. cyl.		mm	mm
51	31	1/8"	28	9,73 8,57
52	32	1/4"	19	13,16 11,45
53	33	3/8"	19	16,66 14,95
54	34	1/2"	14	20,96 18,63
55	35	5/8"	14	22,91 20,59
56	36	3/4"	14	26,44 24,12
57	37	1"	11	33,25 30,29
58	38	1-1/4"	11	41,91 38,95
59	39	1-1/2"	11	47,80 44,85
60	40	2"	11	59,62 56,66
		2-1/4"	11	65,71 62,75

INDEX

Seite
page

	Niederdruckschläuche / Industrieschläuche low pressure hoses / industrial hoses	17
	Niederdruckarmaturen low pressure fittings	49
	Polyamidrohr und Armaturen polyamide pipes and armatures	83
	Dichtringe sealing rings	97
	Zentralschmierung central lubrication	133
	Befestigungstechnik fastening technology	161
	Gelenktechnik joint technology	177
	Ölablass- und Verschlusschrauben oil drain and lock plugs	185
	Kältemittelschlauch und Pressarmaturen refrigerant hose and press armatures	193
	Sortimente assortments	205
	Klauenkupplungen und Zubehör für Druckluft claw couplings and accessories for compressed air	221
	Klauenkupplungen, Spritzdüsen und Auslaufventile für Wasser claw couplings, nozzles and taps for water	235
	Kugelhähne und Ventile ball valves and check valves	243
	Rückschlag- und Fußventile check valves and foot valves	247
	Druckluftverschraubungen und Zubehör compressed air connections and accessories	251
	Schlauchklemmen malleable hose clamps	257
	Mörtelkupplungen mortar couplings	261
	Schalenverschraubungen shell unions	267
	Tankwagen-Kupplungen tanker couplings	275
	Kamlok-Kupplungen Kamlok couplings	281
	Kupplungssysteme SMS, Macon, MRV & DAS coupling systems SMS, Macon, MRV & DAS	295
	Storz-Kupplungen Storz couplings	303
	Guillemin-Kupplungen Guillemin couplings	307
	Kupplungssysteme Perrot & Bauer coupling systems Perrot & Bauer	315
	Montageschlüssel mounting wrenches	319
	Adapter adapters	321
	Tempergussverschraubungen malleable iron pipe fittings	329

1. Schlauchleitungen richtig auswählen

Schlauchleitungen dienen zur Übertragung verschiedenster Medien, sie bestehen aus flexiblen Schläuchen, die an beiden Enden kraft- und formschlüssig mit Anschlussarmaturen versehen sind.

Vorschriften beachten...

Gesetzliche und sonstige Bestimmungen müssen beim Einsatz von Hydraulik-Schlauchleitungen mit besonderer Sorgfalt beachtet und dem Hersteller bereits bei der Anfrage bekanntgegeben werden.

Über die Lebensdauer eines Hydraulikschlauches entscheidet unter anderem auch die Einhaltung der Einbauvorschriften.

2. Schlauchleitungsgröße bestimmen

Der erforderliche Innendurchmesser einer Schlauchleitung wird durch den vorgesehenen Betriebsdruck und die Fördergeschwindigkeit bestimmt.

Nicht zu klein dimensionieren...

Zu klein dimensionierte Schlauchleitungen ergeben eine hohe Durchflussgeschwindigkeit des Mediums, wodurch infolge turbulenter Strömung erhebliche Druckverluste, Geräusche und erhöhte Temperaturen auftreten. Dies schadet dem gesamten System.

Sollten in Ausnahmefällen unterdimensionierte Ventilanschlüsse geringere Schlauchdurchmesser erfordern, empfehlen wir, durch Verwendung von Adaptern in Sprunggrößen den Übergang zur richtig dimensionierten Schlauchleitung herzustellen.

3. Dynamischer Betriebsdruck ist maßgebend

Hydraulik-Schlauchleitungen werden in der Praxis vorwiegend dynamisch beansprucht und sind in ihrer Belastbarkeit auf den höchstzulässigen Betriebsdruck ausgelegt, der für die jeweiligen Schlauchtypen und -dimensionen angegeben ist.

4. Platzdruck darf nie erreicht werden

Die Angaben über den Platzdruck sind Mindestwerte, und gelten nur für noch unbenutzte Schlauchleitungen.

Für den Anwender darf der Platzdruck eines Schlauches oder einer Schlauchleitung nur theoretische Bedeutung besitzen. Unter Bedachtnahme auf die an jede Anlage zu stellenden Sicherheitsanforderungen darf dieser in der Praxis nie - auch nicht annähernd - erreicht werden.

Es ist ein Irrtum, anzunehmen, dass vergleichbare Schläuche verschiedener Hersteller unter gleichen Betriebsbedingungen eine um so längere Lebensdauer haben, je höher die Wertangabe für den Platzdruck ist. Für den Konstrukteur sind nur die dynamischen Druckwert relevant!

1. to select hose lines correctly

Hose lines serve for the transmission of different media, it consist of flexible hoses, which are provided with connection armatures at both ends force and positive-locking.

Compliance with the regulations...

Legal and other regulations must be considered of the use by hose lines with special care and must be given to the manufacturer already with the inquiry.

Among other things also the observance to the installation requirements decide on the life span of a hose.

2. to determine the hose line size

The necessary inside diameter of a hose line is determined by the intended operating pressure and the conveying speed.

Do not dimension too small...

Too small dimensioned hose lines result in a high flow velocity of the medium, whereby due turbulent current substantially pressure losses, noises and increased temperatures arise. This harms the entire system.

If under-sized connections should require smaller hose diameters in exceptional cases, we recommend, to manufacture by use of adapters in several steps the transition to the correctly dimensioned hose line.

3. Dynamic operating system is determining

Hose lines are stressed in practice predominantly dynamically and are in its maximum stress appropriate for the maximum operating pressure, which is indicated for the respective hose type and dimension.

4. Burst pressure may be never achieved

The data concerning burst pressure are minimum values and apply only to still unused hose lines.

For the user the burst pressure of a hose or a hose line may possess only theoretical meaning. Under attention placing to the safety requirements of each system may this in practice never - also not approximately - be achieved.

It is a mistake to assume, that comparable hoses of different manufacturers under the same operating conditions have a longer life span, if the declared value for burst pressure is higher. For the technical designer are only the dynamic pressure values of importance!

5. Temperatur beeinflusst Einsatzdauer

Die für Schläuche angegebenen Betriebstemperaturen beziehen sich auf die Maximaltemperatur des Mediums, wobei auch die Umgebungstemperatur berücksichtigt werden muss. Dauerbetrieb bei hohen Temperaturen kann die Lebensdauer der Schlauchleitungen sowie den sicheren Sitz der Armaturen beeinträchtigen.

Temperaturbeständigkeit medienabhängig...

Schlauchleitungen können daher nicht für alle Medien im angegebenen Temperaturbereich eingesetzt werden. In speziellen Anwendungsfällen ersuchen wir um Ihre Rückfrage.

Wenn Schlauchleitungen in Bezug auf Betriebsdruck, Biegeradius und Temperatur des Mediums und der Umgebung nicht dauernd im Grenzbereich beansprucht werden, kann man mit einer wesentlich höheren Lebensdauer rechnen.

6. Längenänderungen berücksichtigen

Bei jedem Schlauch kommt es unter Druckbelastung zu Längenveränderungen. Laut Norm dürfen diese Werte bei maximalem Betriebsdruck zwischen -4% und +2% liegen.

Bei der Bestimmung der Nennlänge einer armierten Schlauchleitung muss diese Längenveränderung - im Einzelfall - berücksichtigt werden.

7. Chemische Beständigkeit beachten

Wesentlich bei der Auswahl einer Schlauchleitung ist auch die Beachtung der chemischen Beständigkeit der Schlauchseele in Bezug auf Art, Konzentration und Temperatur des Mediums, der Umgebungstemperatur sowie der Einwirkungsdauer. Grundsätzlich ist die Schlauchseele im angegebenen Temperaturbereich gegen Hydraulikflüssigkeiten auf Mineral- oder Syntheseölbasis, gegen Glykol-Wasser-Gemische sowie Öl-Wasser-Emulsionen, nicht jedoch gegen phosphat- Ester-Flüssigkeiten (HFD) beständig.

8. Biegeradius nicht unterschreiten

Die angegebenen Mindestbiegeradien gelten für den zulässigen maximalen Betriebsdruck bei unbewegter Schlauchleitung.

Bei Unterschreitung des empfohlenen Mindestbiegeradius wird die Lebensdauer von Schlauchleitungen beeinträchtigt. In diesem Fall ist der Betriebsdruck herabzusetzen.

5. Temperature affects length of application

The operating temperature indicated for hoses refer to the maximum temperature of the medium, whereby also the ambient temperature must be considered.

Temperature-stability medium-dependently...

Hose lines cannot be used for all media in the indicated temperature range. In special applications we ask for your further inquiry.

If hose lines are not stressed regarding operating pressure, bending radius, temperature of the medium and the environment continuously in the frontier, you can count with a substantially higher life span.

6. to consider length variations

With each hose it comes under pressure load to length variations. According to standard these values may lie with maximum operating pressure between -4% and +2%.

With the determination of the nominal length of a reinforced hose line this length variation must - in individual case - be considered.

7. to consider chemical stability

Substantially with the selection of a hose line also the attention of the chemical stability of the hose soul as regarding to the kind, concentration and temperature of the medium, the ambient temperature as well as the time of reaction.

In principle the hose soul is resistant in the indicated temperature range against hydraulic fluids on mineral or synthesis oil basis, to glycol water mixtures as well as oil/water emulsions, not however to phosphate ester liquids (HFD).

8. do not fall below bending radius

The indicated minimum bending radii apply to the permissible maximum operating pressure during motionless hose line.

In the case of falling below the recommended minimum bending radius the life span of hose lines is impaired. In this case the operating pressure is to be lowered.

Richtige Lagerung verlängert die Lebensdauer

- Der Lagerraum soll kühl (bis +20°C), trocken (rel. Luftfeuchtigkeit max. 65%) und vor Sonnenlichteinfall geschützt sein. Ozon- und UV-Einwirkung beeinträchtigen die Lebensdauer des Schlauches.
- Es sind jeweils die ältesten auf Lager befindlichen Schläuche oder Leitungen zuerst zu verwenden.
- (Die Lagerzeit sollte bei Schläuchen 4 Jahre und bei Schlauchleitungen 2 Jahre nicht überschreiten)
- Nähere Angaben Siehe DIN 7716.

Correct storage extends the life span

- The stockroom should be coolly (to +20°C) dry (relative air humidity max 65%) and protected against sunshine. Ozone and UV effect impair the life span of the hose.
- The oldest hoses or lines present in stock are to be used in each case first.
- (The storage time should not exceed 4 years of hoses and 2 years of hose lines)
- More data see DIN 7716.

Schäden vermeiden – Sicherheit gewährleisten damage avoids – security ensure

Schadhafte Schlauchleitungen können einem Unternehmen nicht nur unerwartete Kosten verursachen, sondern unter Umständen auch zu folgenschweren Unfällen führen.

Defective hose lines can cause not only unexpected costs for an enterprise, but perhaps also to consequence-fraught accidents.

1. Voraussetzung für den sicheren Betrieb

- Wahl der Schlauchleitungen entsprechend dem Betriebsdruck, den Einsatzbedingungen und der Nennwerte
- Einsatzbereiche gemäß einschlägiger Normen oder sonstiger Regelungen
- Fachgerechte Einbindung, richtige, sorgfältige Verlegung
- Sofortiger Ersatz beschädigter Schlauchleitungen

1. Conditions for the safe enterprise

- Choice of the hose lines according to the operating pressure, the operating conditions and the nominal values
- Areas of application in accordance with relevant standards or either regulations
- Professional integration, correct and careful installation
- Immediate replacement of damaged hose lines

2. Hauptursachen von Beschädigungen

- Mechanische Verletzung
- zu starke Biegung
- Extremer Zug
- Überdurchschnittliche Verdrehung
- Quetschung
- Ungeeignetes Medium

2. Main causes of damages

- Mechanical injury
- to strong bend
- Extreme course
- Above average twist
- Squeezing
- Unsuitable medium

3. Regelmäßige Prüfung zur Früherkennung von Schäden auf

- Einwandfreien Zustand der Schlauchaußenschicht – keine Risse, Blasen Verformungen, Abrieb oder Knickstellen
- Ordnungsgemäße Armaturenmontage
- Fachgerechte Verlegung – extreme Knickung, zu starke Zugbeanspruchung, gewaltsame Verdrehung
- Kontrolle der Dichtheit

3. Regular examination for the early recognition of damage up

- Perfect condition of the hose external layer – no fissures, blisters, deformations, abrasion or buckling
- Normal armature assembly
- Professional installation – avoid extreme buckling, to strong tensile stress and twisting by force
- Control of the tightness

4. Verfahrensablauf beim Auswechseln von Schlauchleitungen

- Sicherstellung des drucklosen Zustandes
- Überprüfung, ob die Ersatzleitung der Spezifikation entspricht
- Einbau der Ersatzleitung
- Wiederherstellen des Betriebsdruckes
- Überprüfung der Dichtheit

4. Operational sequence while replacing a hose line

- to secure of the pressure-free condition
- Check, if the spare circuit corresponds to the specification
- Installation of the spare circuit
- Restore the operating pressure
- Control of the tightness

Längentoleranzen bei montierten Schlauchleitungen

(laut DIN 20066)

Longitudinal tolerance of installed hose lines

(according to DIN 20066)

Länge/mm length/mm	Toleranzen tolerances		
	bis DN 25 up to DN 25	ab DN 32 bis DN 50 from DN 32 to DN 50	ab DN 60 bis DN 100 from DN 60 to DN 100
bis 630 up to 630	+ 7mm - 3mm	+ 12 mm - 4 mm	
630 – 1250	+ 12 mm - 4 mm	+ 20 mm - 6mm	+ 25 mm - 6 mm
1250 – 2500	+ 20 mm - 6 mm	+ 25 mm - 6 mm	
2500 – 8000		1,50% -0,50%	
über 8000 more than 8000		3% -1%	

Ermittlung der Schlauchlänge

Die Lebensdauer von Schlauchleitungen erhöht sich bei ordnungsgemäßer Bemessung und Montage. Daher bitte folgende Hinweise beachten:

Calculating the hose length

The service life of hose assemblies can be increased by proper measurement and installation. Please follow the following instructions:

Berechnung von fest installierten Leitungen: Gesamtlänge $L=2B+3,14 \times R$

Gesamtlänge $L=2B+3,14 \times R+C$

Calculation of flexible hose lines: Overall length $L=2B+3,14 \times R$

Overall length $L=2B+3,14 \times R+C$

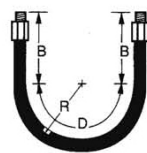

$R \geq$ Mindestbiegeradius

$R \geq$ minimum bend radius

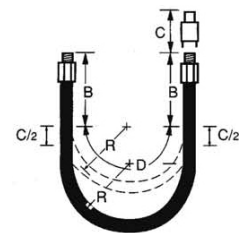

Bei Hubbewegung ist die Zusatzlänge C zu berücksichtigen.

With lifting movements the additional length C should be taken into account.

Aus nachstehender Tabelle ist in Abhängigkeit vom Durchmesser die mindest zu belassende Länge B hinter den Armaturenden einer Schlauchleitung zu entnehmen.

The following table gives, depending on the hose diameter, the minimum length B that should be left behind of the end of the fitting of a hose assembly.

DN-Ø	6	8	10	12	16	20	25	32	40
"B" (mm)	90	100	110	120	130	140	160	180	200

Messbeispiele für Schlauchleitungen

Measuring hose assemblies

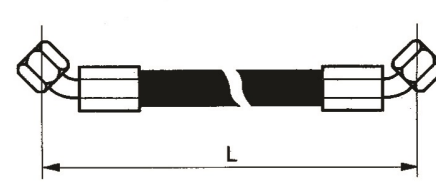
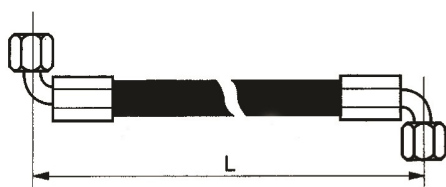

Blickrichtung

Direction of View

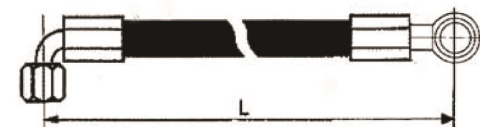

*) Bestellbeispiel:
GCK NW 8x1.000, DKL 90° / DKL 90° - 180°

*) Order example:
GCK NW 8x1.000, DKL 90° / DKL 90° - 180°

Bestimmung der Winkeleinstellung / determination of the angle-position

Die Winkeleinstellung bei Schlauchleitungen mit beidseitigen Krümmer- oder Ringarmaturen bitten wir wie folgt zu bestimmen:

Man blickt entlang der zu bezeichnenden Schlauchleitung, wobei die hintere, vom Körper entfernten Armatur nach oben zeigt. Dann gibt man an, um wie viel Grad die vordere Armatur im Uhrzeigersinn verdreht ist; Toleranz $\pm 3^\circ$

Bei der Montage von Krümmerarmaturen mit Ringarmaturen liegt das Ringstück flach, und ist die vom Körper entfernte Armatur.

The angle of hose assemblies with elbow fittings at either end can be determined as follows:

Look along the hose assembly for which a designation is required, with the rear fitting away from the body pointing upwards. Now specify how many degrees the front fitting is rotated through in a clockwise direction; Tolerance $\pm 3^\circ$

At the assembly of elbow fittings with ring fitting, the fitting with the ring ring is laying flat, and away from body.

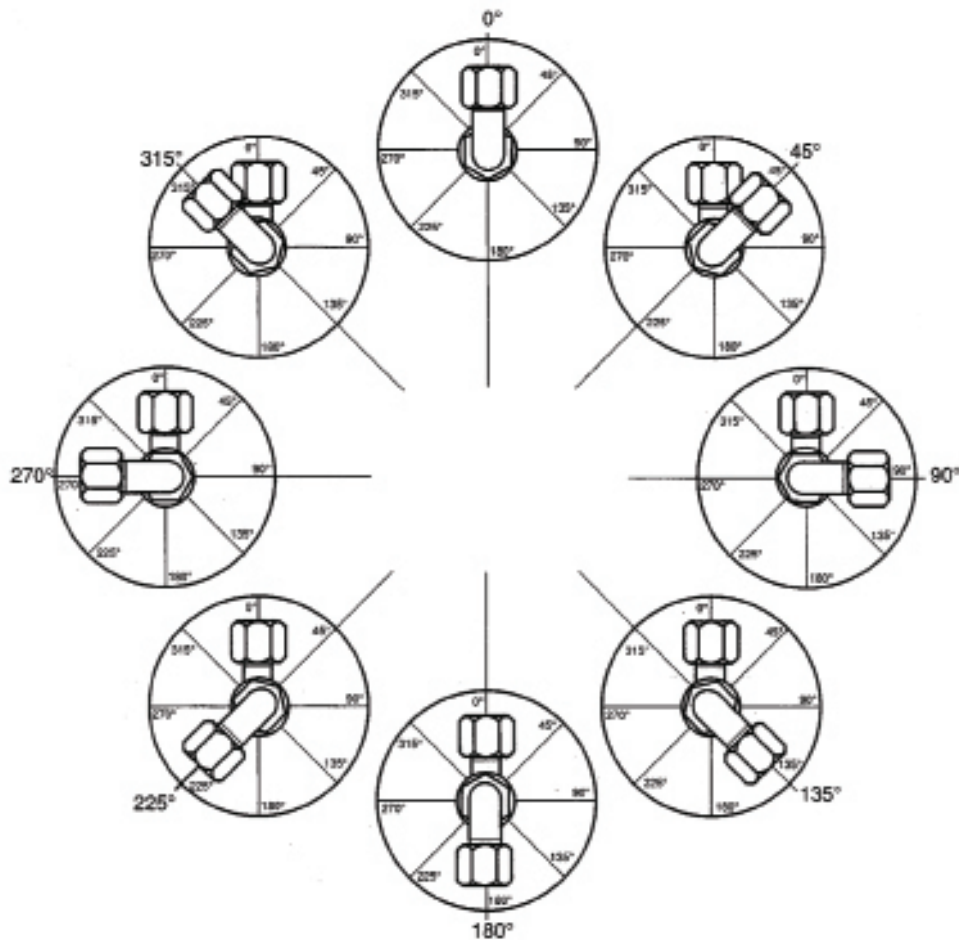

Nomogramm zur Bestimmung der Nennwerte

Das Nomogramm dient als Hilfsmittel für die Auswahl der Nennweiten von Schlauch- und Rohrleitungen.

Nomogramm for determination of nominal diameter

The nomogram can be used as an aid to select the nominal diameters of hose and pipe assemblies.

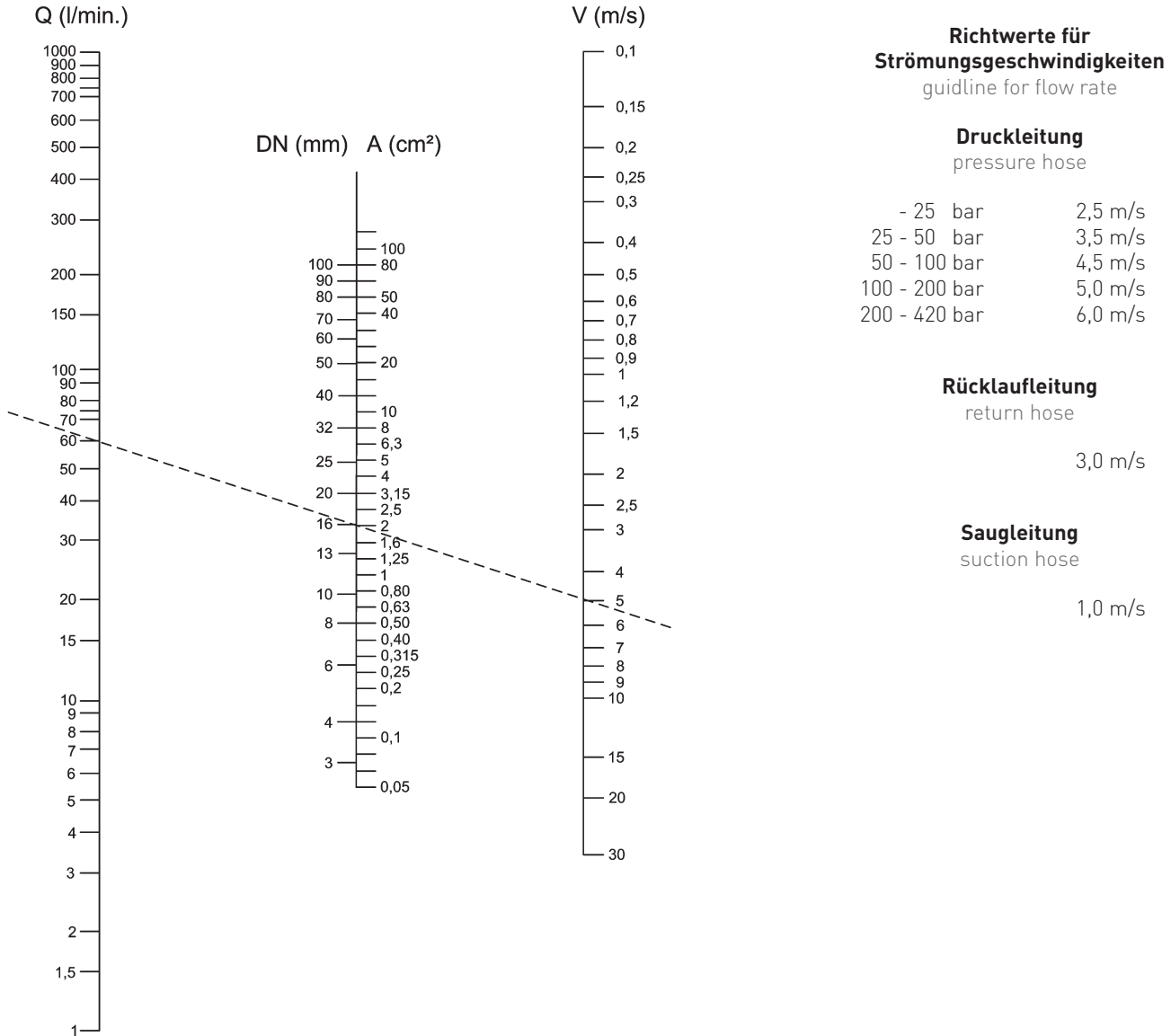

Beispiel:

Durchflussmengen Q = 60 l/min (linke Skala). Gewählte Geschwindigkeit V = ca. 5m/sek (rechte Skala). Als Schnittpunkt mit der mittleren Skala ergibt sich die Nennweite von 16 mm. Für die endgültige Festlegung der Nennweiten sind noch weitere Faktoren der Anlage zu berücksichtigen, wie: Länge der Leitungen, Anzahl der Ventile, Viskosität des Öles und maximal zulässiger Druckverlust. Die Nennweite kann auch mit der unten stehenden Formel errechnet werden. Q und V ist mit den oben genannten Dimensionen einzusetzen. Den Werten des Nomogramms liegen Hydrauliköle mit einer Viskosität von max. 315 S.S.U. (9° E) bei +38°C (+100° F) zugrunde, wobei die Arbeitstemperatur zwischen +18°C (+65° F) und +68°C (+155° F) liegt.

Example:

Rate flow Q = 60l/min (left-hand-scale), chosen speed V = approx. 5m/sec. (right-hand-scale). The point of intersection on the middle scale gives a nominal diameter of 16 mm. Other parameters of the installation, such as length of hose assemblies, number of valves, viscosity of the oil and maximum permissible pressure loss, most taken into account when determining final nominal diameters. The nominal diameter can also be determined by using the formula below, where Q and V must be inserted as above. The values of the nomogram are based on hydraulic oils with a maximum viscosity of 315 S.S.U (9° E) at +38°C (+100°F) at an operating temperature of between +18 °C (+65°F) and +68°C (+155°F).

$$DN = \sqrt{\frac{Q \cdot 400}{V \cdot 3.14 \cdot 6}}$$

Richtiges Verlegen von Schlauchleitungen erhöht die Lebensdauer

1. Bei Schlauchleitungen können unter Betriebsdruck Längenänderungen von +2% bis -4% auftreten.
Daher soll der Einbau mit Durchhang oder in Bogenform erfolgen.
2. Schlauchleitungen dürfen nicht verdreht eingebaut werden (keine Torsion).
3. Schlauchleitungen nicht übermäßig krümmen - Bogenarmaturen verwenden!
4. Mindestbiegeradius beachten!
5. Im Falle von Hubbewegungen den Hub berücksichtigen.
6. Gegen äußere Beschädigungen schützen (Knickschutzspiralen verwenden).

Correct installation increases the service life of hose assemblies

1. Under pressure, alterations of +2% to -4% can occur in the length of hose assemblies.
Hoses should therefore be installed with slack or curves.
2. Hoses assemblies should never be installed twisted (no torsion).
3. Hoses assemblies should not be bent excessively - use elbow fittings instead!
4. Note minimum bend radius!
5. If vertical displacement occurs, allow for amount of travel.
6. Protect from external damage (use protective spirals).

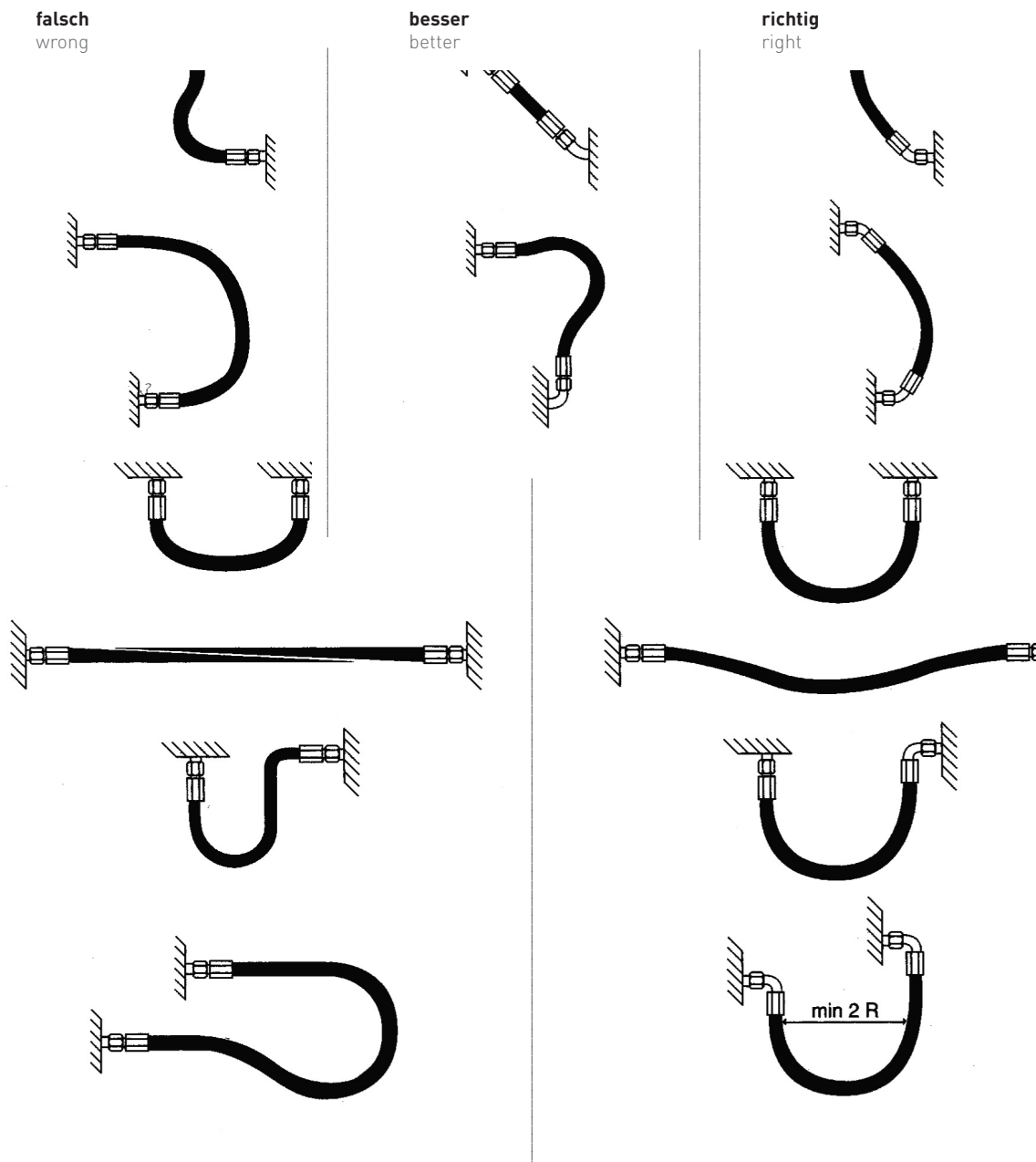

Umrechnungstabelle Maßeinheiten conversion tables for measuring units

Längen length				Flächen surfaces					
Meter	x	39,37	=	Inches	cm ²	x	0,155	=	inches ²
	x	3,281	=	Feet	Square inches	x	6,45	=	cm ²
	x	1,094	=	Yards	Druck pressure				
Inches	x	25,4	=	mm	bar	x	1,02	=	kp/cm ²
Feet	x	304,8	=	mm		x	14,5	=	lbs/in ²
Yards	x	0,914	=	Meter		x	0,987	=	atm
Volumen volume						x	100	=	kN/m ²
Liter (1000cm ³)	x	61,023	=	Cubic inches	lbs/in ²	x	0,068	=	atm
	x	0,035	=	Cubic feet		x	0,070	=	kp/cm ²
	x	0,22	=	Imperial gallons		x	6,895	=	kN/m ²
	x	0,264	=	U.S. gallons		x	0,069	=	bar
Cubic inches	x	0,016	=	Liter	kp/m ²	x	14,223	=	lbs/in ²
	x	0,004	=	Imperial gallons		x	0,968	=	atm
	x	0,004	=	U.S. gallons		x	0,981	=	bar
Imperial gallons	x	4,546	=	Liter		x	98,07	=	kN/m ²
	x	277,274	=	Cubic inches	kN/m ²	x	0,145	=	lbs/in ²
	x	0,161	=	Cubic feet		x	0,010	=	kp/cm ²
	x	1,2	=	U.S. gallons		x	0,010	=	atm
U.S. Gallons	x	3,785	=	Liter		x	0,01	=	bar
	x	231	=	Cubic inches	atm	x	14,696	=	lbs/in ²
	x	0,134	=	Cubic feet		x	1,032	=	kp/cm ²
	x	0,833	=	Imperial gallons		x	1,013	=	bar
						x	101,3	=	kN/m ²

Inches (Zoll)		mm		Inches (Zoll)		mm		Inches (Zoll)		mm	
	1/64	0,016	0,397		23/64	0,359	9,128		45/64	0,703	17,895
	1/32	0,031	0,794	3/8		0,375	9,533		23/32	0,719	18,256
	3/64	0,047	1,191		25/64	0,391	9,922		47/64	0,734	18,653
1/16		0,063	1,588		13/32	0,406	10,319	3/4		0,750	19,050
	5/64	0,078	1,984		27/64	0,422	10,716		49/64	0,766	19,447
	3/32	0,094	2,381	7/16		0,438	11,113		25/32	0,781	19,844
	7/64	0,109	2,778		29/64	0,453	11,509		51/64	0,797	20,241
1/8		0,125	3,175		15/32	0,469	11,906	13/16		0,813	20,638
	9/64	0,141	3,572		31/64	0,484	12,303		53/63	0,828	21,034
	5/32	0,156	3,969	1/2		0,500	12,700		27/32	0,844	21,431
	11/64	0,172	4,366		33/64	0,516	13,097		55/64	0,859	21,828
3/16		0,188	4,763		17/32	0,531	13,494	7/8		0,875	22,225
	13/64	0,203	5,159		35/64	0,547	13,891		57/64	0,891	22,622
	7/32	0,219	5,556	9/16		0,563	14,288		29/32	0,906	23,019
	15/64	0,234	5,953		37/64	0,578	14,684		59/64	0,922	23,416
1/4		0,250	6,350		19/32	0,594	15,081	15/16		0,938	23,813
	17/64	0,266	6,747		39/64	0,609	15,478		61/64	0,953	24,209
	9/32	0,281	7,144	5/8		0,625	15,875		31/32	0,969	24,606
	19/64	0,297	7,541		41/64	0,641	16,272		63/64	0,984	25,003
5/16		0,313	7,938		21/32	0,656	16,669			1,000	25,400
	21/64	0,328	8,334		43/64	0,672	17,066				
	11/32	0,344	8,731	11/16		0,688	17,463				

**Umrechnungstabelle für:
BAR → POUNDS/SQUARE INCH**

1BAR = 14,5035PSI

**Conversion table for:
BAR → POUNDS/SQUARE INCH**

1BAR = 14,5035PSI

bar	0	1	2	3	4	5	6	7	8	9
	psi	psi	psi	psi	psi	psi	psi	psi	psi	psi
0		14,50	29,00	43,51	58,01	72,52	87,02	101,52	116,03	130,53
10	145,03	159,54	174,04	188,54	203,05	217,55	232,05	246,56	261,06	275,57
20	290,70	304,57	319,07	333,58	348,08	362,59	377,09	391,59	406,10	420,60
30	435,10	449,61	464,11	478,61	493,12	507,62	522,12	536,63	551,13	565,64
40	580,14	594,64	609,14	623,65	638,15	652,66	667,16	681,66	696,17	710,67
50	725,17	739,68	754,18	768,68	783,19	797,69	812,19	826,70	841,20	855,71
60	870,21	884,71	899,22	913,72	928,22	942,73	957,23	971,73	986,24	1000,74
70	1015,24	1029,75	1044,25	1058,75	1073,26	1087,76	1102,26	1116,77	1131,27	1145,77
80	1160,28	1174,78	1189,28	1203,79	1218,29	1232,80	1247,30	1261,80	1276,31	1290,81
90	1305,31	1319,81	1334,32	1348,82	1363,33	1377,83	1392,33	1406,84	1421,34	1435,85
100	1450,35	1464,85	1479,35	1493,86	1508,36	1522,87	1537,37	1551,87	1566,38	1580,88

**Umrechnungstabelle für:
POUNDS/SQUARE INCH → BAR**

1PSI = 0,0689 BAR

**Conversion table for:
POUNDS/SQUARE INCH → BAR**

1PSI = 0,068 BAR

psi	0	1	2	3	4	5	6	7	8	9
	bar	bar	bar	bar	bar	bar	bar	bar	bar	bar
0		0,069	0,138	0,206	0,275	0,344	0,413	0,482	0,551	0,620
10	0,689	0,758	0,827	0,895	9,640	1,033	1,102	1,171	1,240	0,309
20	1,378	1,447	1,516	1,584	1,653	1,722	1,791	1,860	1,929	1,998
30	2,067	2,136	2,205	2,273	2,342	2,411	2,480	2,549	2,618	2,687
40	2,756	2,825	2,894	2,962	3,031	3,100	3,169	3,238	3,307	3,376
50	3,445	3,514	3,583	3,651	3,720	3,789	3,858	3,927	3,996	4,065
60	4,134	4,203	4,272	4,340	4,409	4,478	4,547	4,616	4,685	4,754
70	4,823	4,892	4,961	5,029	5,098	5,167	5,236	5,305	5,374	5,443
80	5,512	5,581	5,650	5,718	5,787	5,856	5,925	5,994	6,063	6,132
90	6,201	6,270	6,339	6,407	6,476	6,545	6,614	6,683	6,752	6,821
100	6,890	6,959	7,028	7,096	7,165	7,234	7,303	7,372	7,441	7,510

Umrechnungstabelle Temperaturen conversion tables for temperatures

°C ← °F			°C ← °F			°C ← °F			°C ← °F			°C ← °F		
°C → °F			°C → °F			°C → °F			°C → °F			°C → °F		
-73,3	-100,0	-148,0	0,0	32,0	89,6	30,6	87,0	188,6	60,5	141,0	285,8	190,6	375,0	707,0
-67,8	-90,0	-130,0	0,6	33,0	91,4	31,1	88,0	190,4	61,1	142,0	287,6	193,4	380,0	716,0
-62,2	-80,0	-112,0	1,1	34,0	93,2	31,7	89,0	192,2	61,6	143,0	289,4	196,1	385,0	725,0
-56,7	-70,0	-94,0	1,7	35,0	95,0	32,2	90,0	194,0	62,2	144,0	291,2	198,9	390,0	734,0
-51,1	-60,0	-76,0	2,3	36,0	96,8	32,8	91,0	195,8	62,7	145,0	293,0	201,7	395,0	743,0
-45,6	-50,0	-58,0	2,8	37,0	98,6	33,3	92,0	197,6	63,3	146,0	294,8	204,4	400,0	752,0
-42,8	-45,0	-49,0	3,4	38,0	100,4	33,9	93,0	199,4	63,8	147,0	296,6	207,2	405,0	761,0
-40,0	-40,0	-40,0	3,9	39,0	102,2	34,4	94,0	201,2	64,4	148,0	298,4	210,0	410,0	770,0
-37,2	-35,0	-31,0	4,5	40,0	104,0	35,0	95,0	203,0	65,0	149,0	300,2	212,8	415,0	779,0
-34,5	-30,0	-22,0	5,0	41,0	105,8	35,6	96,0	204,8	65,5	150,0	302,0	215,6	420,0	788,0
-31,7	-25,0	-13,0	5,6	42,0	107,6	36,1	97,0	206,6	68,3	155,0	311,0	218,4	425,0	797,0
-28,9	-20,0	-4,0	6,1	43,0	109,4	36,7	98,0	208,4	71,0	160,0	320,0	221,1	430,0	806,0
-26,1	-15,0	5,0	6,7	44,0	111,2	37,2	99,0	210,2	73,8	165,0	329,0	223,9	435,0	815,0
-23,2	-10,0	14,0	7,2	45,0	113,0	37,8	100,0	212,0	76,6	170,0	338,0	266,7	440,0	824,0
-22,7	-9,0	15,8	7,8	46,0	114,8	38,3	101,0	213,8	79,3	175,0	347,0	229,4	445,0	833,0
-22,2	-8,0	17,6	8,3	47,0	116,6	38,9	102,0	215,6	82,1	180,0	356,0	232,2	450,0	842,0
-21,6	-7,0	19,4	8,9	48,0	118,4	39,4	103,0	217,4	85,0	185,0	365,0	235,0	455,0	851,0
-21,1	-6,0	21,2	9,5	49,0	120,2	40,0	104,0	219,2	87,8	190,0	374,0	237,8	460,0	860,0
-20,5	-5,0	23,0	10,0	50,0	122,0	40,6	105,0	221,0	90,5	195,0	383,0	240,6	465,0	869,0
-20,0	-4,0	24,8	10,6	51,0	123,8	41,1	106,0	222,8	93,3	200,0	392,0	243,4	470,0	878,0
-19,4	-3,0	26,6	11,1	52,0	125,6	41,7	107,0	224,6	96,1	205,0	401,0	246,1	475,0	887,0
-18,9	-2,0	28,4	11,7	53,0	127,4	42,2	108,0	226,4	98,9	210,0	410,0	248,9	480,0	896,0
-18,3	-1,0	30,2	12,2	54,0	129,2	42,8	109,0	228,2	101,6	215,0	419,0	251,7	485,0	905,0
-17,8	0,0	32,0	12,8	55,0	131,0	43,3	110,0	230,0	104,4	220,0	428,0	254,4	490,0	914,0
-17,2	1,0	33,8	13,3	56,0	132,8	43,9	111,0	231,8	107,2	225,0	437,0	257,2	495,0	923,0
-16,7	2,0	35,6	13,9	57,0	134,6	44,4	112,0	233,6	110,0	230,0	446,0	260,0	500,0	932,0
-16,1	3,0	37,4	14,4	58,0	136,4	45,0	113,0	235,4	112,7	235,0	455,0	265,5	510,0	950,0
-15,6	4,0	39,2	15,0	59,0	138,2	45,6	114,0	237,2	115,5	240,0	464,0	271,1	520,0	968,0
-15,0	5,0	41,0	15,6	60,0	140,0	46,1	115,0	239,0	118,2	245,0	473,0	276,6	530,0	986,0
-14,4	6,0	42,8	16,1	61,0	141,8	46,7	116,0	240,8	121,0	250,0	482,0	282,1	540,0	1004,0
-13,9	7,0	44,6	16,7	62,0	143,6	47,2	117,0	242,6	123,8	255,0	491,0	287,7	550,0	1022,0
-13,3	8,0	46,4	17,2	63,0	145,4	47,8	118,0	244,4	126,6	260,0	500,0	293,3	560,0	1040,0
-12,8	9,0	48,2	17,8	64,0	147,2	48,3	119,0	246,2	129,4	265,0	509,0	298,8	570,0	1058,0
-12,2	10,0	50,0	18,3	65,0	149,0	48,9	120,0	248,0	132,2	270,0	518,0	304,4	580,0	1076,0
-11,7	11,0	51,8	18,9	66,0	150,8	49,4	121,0	249,8	135,0	275,0	527,0	310,0	590,0	1094,0
-11,1	12,0	53,6	19,4	67,0	152,6	50,0	122,0	251,6	137,7	280,0	536,0	315,5	600,0	1112,0
-10,6	13,0	55,4	20,0	68,0	154,4	50,6	123,0	253,4	140,5	285,0	545,0	321,1	610,0	1130,0
-10,0	14,0	57,2	20,6	69,0	156,2	51,1	124,0	255,2	143,3	290,0	554,0	326,6	620,0	1148,0
-9,5	15,0	59,0	21,1	70,0	158,0	51,7	125,0	257,0	146,1	295,0	563,0	332,2	630,0	1166,0
-8,9	16,0	60,8	21,6	71,0	159,8	52,2	126,0	258,8	148,9	300,0	572,0	337,7	640,0	1184,0
-8,3	17,0	62,6	22,2	72,0	161,6	52,8	127,0	260,6	151,7	305,0	581,0	343,3	650,0	1202,0
-7,8	18,0	64,4	22,7	73,0	163,4	53,3	128,0	262,4	154,5	310,0	590,0	348,8	660,0	1220,0
-7,2	19,0	66,2	23,3	74,0	165,2	53,9	129,0	264,2	157,2	315,0	599,0	354,4	670,0	1238,0
-6,7	20,0	68,0	23,9	75,0	167,0	54,4	130,0	266,0	160,0	320,0	608,0	360,0	680,0	1256,0
-6,1	21,0	69,8	24,4	76,0	168,8	55,0	131,0	267,8	132,8	325,0	617,0	365,5	690,0	1274,0
-5,6	22,0	71,6	25,0	77,0	170,6	55,5	132,0	269,6	165,6	330,0	626,0	371,1	700,0	1292,0
-5,0	23,0	73,4	25,6	78,0	172,4	56,1	133,0	271,4	168,4	335,0	635,0	376,6	710,0	1310,0
-4,5	24,0	75,2	26,1	79,0	174,2	56,6	134,0	273,2	171,1	340,0	644,0	382,2	720,0	1328,0
-3,9	25,0	77,0	26,7	80,0	176,0	57,2	135,0	275,0	173,9	345,0	653,0	387,7	730,0	1346,0
-3,4	26,0	78,8	27,2	81,0	177,8	57,7	136,0	276,8	176,7	350,0	662,0	393,3	740,0	1364,0
-2,8	27,0	80,6	27,8	82,0	179,6	58,3	137,0	278,6	179,5	355,0	671,0	398,8	750,0	1382,0
-2,3	28,0	82,4	28,3	83,0	181,4	58,8	138,0	280,4	182,2	360,0	680,0	404,4	760,0	1400,0
-1,7	29,0	84,2	28,9	84,0	183,2	59,4	139,0	282,2	185,0	365,0	689,0	410,0	770,0	1418,0
-1,1	30,0	86,0	29,4	85,0	185,0	60,0	140,0	284,0	187,8	370,0	698,0	415,5	780,0	1436,0
-0,6	31,0	87,8	30,0	86,0	186,8									

Gewinde und Anschlussarten threads and junctions

Armaturenausführung Standard fitting design standard			SFL 3	SFS 6	RNM	DKL DKOL CEL		DKS DKOS CES		AGM DKM	DKR AGJ	DKJ AGJ	AGN	ORFS		
Größe size	DN	Inch	Flansch 3000 PSI flange 3000 PSI		Flansch 6000 PSI flange 6000 PSI		RN Innen-Ø internal-Ø	Metrisch metric	RA	Metrisch metric	RA	Metrisch metric	BSP 60° Zoll	JIC UNF 37°	NPTF	UNF (UN, UNS)
			Zoll	Ø	Zoll	Ø		DIN 3861 24° LB		DIN 3861 24° SB		DIN 7631 60°				
03	05	3/16"						M 12x1,5	06	M 16x1,5	08	M 12x1,5	1/8"			
04	06	1/4"					12	M 14x1,5	08	M 18x1,5	10	M 14x1,5	1/4"	7/16" -20	1/4" -18	9/16" -18
05	08	5/16"					14	M 16x1,5	10	M 20x1,5	12	M 16x1,5	3/8"	1/2" -20	3/8" -18	
06	10	3/8"					16	M 18x1,5	12	M 22x1,5	14	M 18x1,5	3/8"	9/16" -18	3/8" -18	11/16" -16
08	12	1/2"	1/2"	30,2	1/2"	31,7	18	M 22x1,5	15	M 24x1,5	16	M 22x1,5	1/2"	3/4" -16	1/2" -14	13/16" -16
10	16	5/8"	3/4"	38,1	3/4"	41,3	22	M 26x1,5	18	M 30x2	20	M 26x1,5	5/8"	7/8" -14	3/4" -14	1" -14
12	20	3/4"	3/4"	38,1	3/4"	41,3	26	M 30x2	22	M 36x2	25	M 30x1,5	3/4"	1.1/16" -12	3/4" -14	13/16" -12
16	25	1"	1"	44,5	1"	47,6	30	M 36x2	28	M 42x2	30	M 38x1,5	1"	1.5/16" -12	1" -11,5	1 7/16" -12
20	32	1.1/4"	1.1/4"	50,8	1.1/4"	54,0		M 45x2	35	M 52x2	38	M 45x1,5	1.1/4"	1.5/8" -12	1.1/4" -11,5	1 11/16" -12
24	40	1.1/2"	1.1/2"	60,3	1.1/2"	63,5		M 52x2	42	M 68x2	50	M 52x1,5	1.1/2"	1.7/8" -12	1.1/2" -11,5	2" -12
32	50	2"	2"	71,4	2"	79,4						M 65x2	2"	2.1/2" -12	2" -11,5	
40	65	2.1/2"	2.1/2"	84,1										3" -12		
48	80	3"	3"	101,6										3.1/2" -12		
56	90	3.1/2"														
64	100	4"														

RA = Rohranschluss
Alle Abmessungen in Millimeter (mm)
Druckangaben in bar

RA = pipe connection
All specifications in millimeter (mm)
pressure specifications in bar

Abkürzungsverzeichnis list of abbreviations

AG	Außengewinde external thread
AL	Aluminium aluminium
CE	Außengewinde mit 24° Aussenkung external thread with 24°
CEL	Außengewinde mit 24° Aussenkung leichte Baureihe external thread with 24° chamfering light duty
CES	Außengewinde mit 24° Aussenkung schwere Baureihe external thread with 24° chamfering heavy duty
Dichtform A	für Dichtringe for sealing ring
Dichtform B	mit Schneidkante with cutting edge
Dichtform C	selbstdichtend durch konisches Gewinde self-sealing by tapered thread
Dichtform E	mit Weichdichtung with soft sealing
DKL	Dichtkegel leichte Baureihe seal cone light series
DKR	Dichtkegel zöllig seal cone inch
HB	Härte Brinell Brinell hardness
IG	Innengewinde internal thread
K	konisch tapered
m	Meter meter
m/WS	Meter/Wassersäule meter/water head
mm	Millimeter millimeter
MS	Messing brass
NW	Nennweite nominal size
PN	Betriebsdruck pressure nominal
RA	Rohranschluss pipe connection
SF-CU	Kupfer copper
ST	Stahl steel
SW	Schlüsselweite width across flats
ÜM	Überwurfmutter union nut
ÜS	Überwurfschraube union screw

Niederdruckschläuche / Industrieschläuche

Low pressure hoses /
industrial hoses

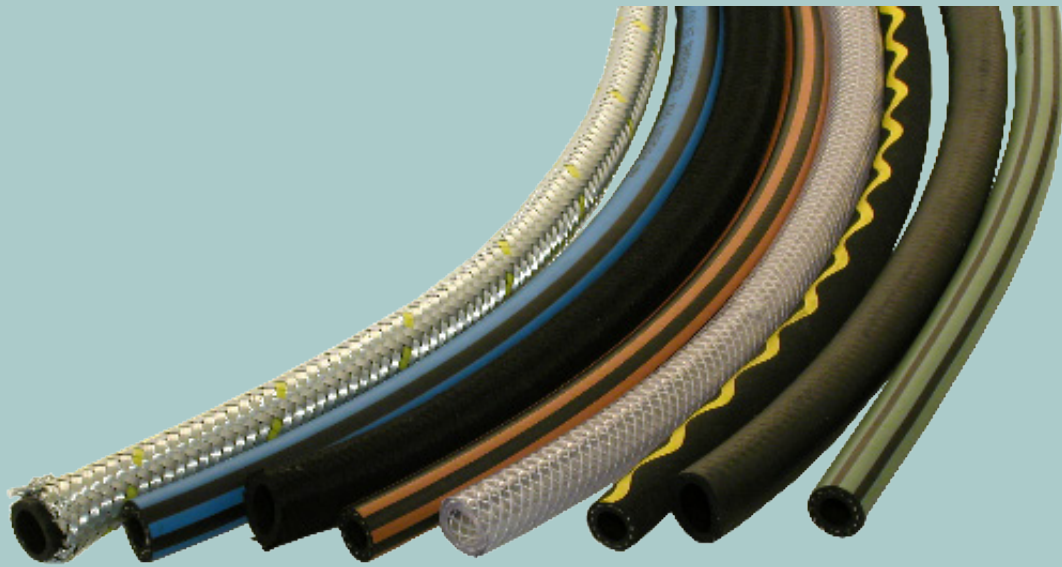

Typ S, A

Typ GCK, GCNA, GCW, GCWA

Typ OLN, OLNH, OLNS 1

Typ KR, KRS

Typ FPM/ECO

Leckölschläuche

PVC-Schläuche Typ PL, A-PL

Kühlerschläuche

PVC-Saug- und Druckschläuche

Kupferrohre

Lactopal, Lactopal L

Goldschlange, Aquapal

Dampftrix 5000, 6000

UNITRIX 60, 80

type S, A

type GCK, GCNA, GCW, GCWA

type OLN, OLNH, OLNS 1

type KR, KRS

type FPM/ECO

overflow oil hoses

PVC hoses Type PL, A-PL

radiator hoses

PVC suction and pressure hoses

copper tube

Lactopal, Lactopal L

golden snake, Aquapal

Dampftrix 5000, 6000

UNITRIX 60, 80

Niederdruckschläuche Typ S low pressure hoses type S



Schlauchkonstruktion:

Schlauch aus synthetischem Gummi

hose construction:

hose from synthetic rubber

Anwendungs- und Temperaturbereich:

application and temperature range:

Motorenschmieröle (HD-Öle)/engine lubricating oils (HD-oils)	+80°C
Hydraulikflüssigkeiten auf Mineral- und Glycolbasis/hydraulic fluids on mineral and glycol base	+80°C
Dieselmotoren/diesel fuels	+80°C
Heizöl EL und L/fuel oil EL and L	+70°C
pflanzliche Schmierfette/herbal greases	+80°C
Luft, Luft ölhaltig/air, oil containing air	+80°C
Kühlstoffe (Glycol, Glysantin, etc.)/cooling materials (Glycol, Glysantin, etc.)	+80°C
Wasser/water	+80°C
Wässrige Lösungen ohne oxydierende Stoffe/waterily solutions without oxidizing materials	+80°C
Kältebeständigkeit/resistance to cold	-35°C

Nennweite nominal size	Innen-Ø internal-Ø mm	Außen-Ø external-Ø mm	Art.-Nr.
2	4,8	8,8	601 202
4	6,0	10,0	601 204
6	8,0	12,0	601 206
8	9,5	13,5	601 208
10	11,5	17,0	601 210
12	14,5	20,5	601 213
16	17,5	24,5	601 216
20	22,0	30,0	601 220
25	25,0	33,0	601 225

Unterdruckschläuche negative pressure hoses



Schlauchkonstruktion:

Schlauch aus synthetischem Gummi

hose construction:

hose from synthetic rubber

Temperaturbereich: -30°C bis +70°C

temperature range: -30°C to +70°C

Nennweite nominal size	Innen-Ø internal-Ø mm	Außen-Ø external-Ø mm	Art.-Nr.
1	3,5	8,0	602 190

Niederdruckschläuche Typ A low pressure hoses type A

nach EN ISO 6806 / DIN 73 379 Typ C
according to EN ISO 6806 / DIN 73 379 type C

Schlauchkonstruktion:

Schlauch aus synthetischem Gummi, eine Umflechtung aus verzinktem Stahldraht

hose construction:

hose from synthetic rubber, one braiding from galvanized steel wire

Anwendungs- und Temperaturbereich:

application and temperature range:

Motorenschmieröle (HD-Öle)/engine lubricating oils (HD-oils)	+80°C
Hydraulikflüssigkeiten auf Mineral- und Glycolbasis/hydraulic fluids on mineral and glycol base	+80°C
Dieselmotoren/diesel fuels	+80°C
Heizöl EL und L/fuel oil EL and L	+70°C
pflanzliche Schmierfette/ herbal greases	+80°C
Luft, Luft ölhaltig/air, oil containing air	+80°C
Kühlstoffe (Glycol, Glysantin, etc.)/cooling materials (Glycol, Glysantin, etc.)	+80°C
Wasser/ water	+80°C
Wässrige Lösungen ohne oxydierende Stoffe/waterily solutions without oxidizing materials	+80°C
Kältebeständigkeit/resistance to cold	-35°C



NW NS	Innen-Ø internal-Ø mm	Außen-Ø external-Ø mm	Biegeradius bend radius mm	Betriebsdruck working pressure bar	Berstdruck burst pressure bar	Prüfdruck test pressure bar	Art.-Nr.
2	4,5	9,5	25	20	60	30	601 302
4	5,5	10,5	25	20	60	30	601 304
6	7,5	12,5	30	15	50	25	601 306
8	9,0	14,0	40	15	50	25	601 308
10	11,0	17,7	45	15	50	25	601 310
12	14,0	21,2	50	15	50	25	601 313
16	17,0	24,0	70	15	50	25	601 316
20	21,5	30,0	90	15	50	25	601 320
25	25,0	35,8	150	12	40	20	601 325

Niederdruckschläuche Typ A auf Spulen low pressure hoses type A on coils

Schlauchkonstruktion sowie Anwendungs- und Temperaturbereich: siehe oben

hose construction as well as application and temperature

range: see above

Nennweite nominal size	Innen-Ø internal-Ø mm	Außen-Ø external-Ø mm	Spulenlänge coil length m	Art.-Nr.
2	4,5	9,5	20	603 302
4	5,5	10,5	20	603 304
6	7,5	12,5	15	603 306
8	9,0	14,0	10	603 308
10	11,0	17,7	5	603 390
12	14,0	21,2	5	603 393



Niederdruckschläuche Typ AVA low pressure hoses type AVA



mit Edelstahlflechtung nach AISI 304 / DIN 1.4301
with stainless steel braiding according to AISI 304 / DIN 1.4301

Schlauchkonstruktion:

Schlauch aus synthetischem Gummi, eine Umflechtung aus Edelstahldraht

hose construction:

hose from synthetic rubber, one braiding from stainless steel wire

Anwendungs- und Temperaturbereich:

application and temperature range:

Motorenschmieröle (HD-Öle)/engine lubricating oils (HD-oils)	+80°C
Hydraulikflüssigkeiten auf Mineral- und Glycolbasis/hydraulic fluids on mineral and glycol base	+80°C
Dieselmotoren/diesel fuels	+80°C
Heizöl EL und L/fuel oil EL and L	+70°C
pflanzliche Schmierfette/ herbal greases	+80°C
Luft, Luft ölhaltig/air, oil containing air	+80°C
Kühlstoffe (Glycol, Glysantin, etc.)/cooling materials (Glycol, Glysantin, etc.)	+80°C
Wasser/ water	+80°C
Wässrige Lösungen ohne oxydierende Stoffe/waterily solutions without oxidizing materials	+80°C
Kältebeständigkeit/resistance to cold	-35°C

NW NS	Innen-Ø internal-Ø mm	Außen-Ø external-Ø mm	Biegeradius bend radius mm	Betriebsdruck working pressure bar	Berstdruck burst pressure bar	Prüfdruck test pressure bar	Art.-Nr.
2	4,5	9,5	25	20	60	30	601 352
4	5,5	10,5	25	20	60	30	601 354
6	7,5	12,5	30	15	50	25	601 356
8	9,0	14,0	40	15	50	25	601 358
10	11,0	17,7	45	15	50	25	601 360
12	14,0	21,2	50	15	50	25	601 363

Niederdruckschläuche Typ GCK low pressure hoses type GCK

nach DIN 73379B
according to DIN 73379B

Schlauchkonstruktion:

Schlauch aus synthetischem Gummi, ein aufvulkanisiertes Textilgeflecht

hose construction:

hose from synthetic rubber, a up-vulcanized textile network

Anwendungs- und Temperaturbereich:

application and temperature range:

Superkraftstoffe/super fuels	+40°C
Diesekraftstoffe (DIN 51 601)/diesel fuels (DIN 51 601)	+80°C
Heizöle EL ,L (DIN 51 603)/fuel oil EL ,L (DIN 51 603)	+70°C
Wasser/water	+80°C
Luft/air	+70°C
Kältebeständigkeit/resistance to cold	-30°C



NW NS	Innen-Ø internal-Ø mm	Außen-Ø external-Ø mm	Biegeradius bend radius mm	Betriebsdruck working pressure bar	Berstdruck burst pressure bar	Prüfdruck test pressure bar	Art.-Nr.
1	3,0	7,0	45	10	30	20	601 501
2	4,5	9,5	45	10	30	20	601 502
4	5,5	10,5	50	10	30	20	601 504
5	7,0	12,0	65	10	30	20	601 505
6	7,5	12,5	65	10	30	20	601 506
8	9,0	15,0	65	10	30	20	601 508
10	11,0	17,5	75	10	30	20	601 510
12	15,0	23,0	95	10	30	20	601 513

Niederdruckschläuche Typ GCK auf Spulen hoses type GCK on coils

Schlauchkonstruktion sowie Anwendungs- und Temperaturbereich: siehe oben

hose construction as well as application and temperature range: see above

Nennweite nominal size	Innen-Ø internal-Ø mm	Außen-Ø external-Ø mm	Spulenlänge coil length m	Art.-Nr.
1	3,0	7,0	20	603 501
2	4,5	9,5	20	603 502
4	5,5	10,5	20	603 504
6	7,5	12,5	15	603 506
8	9,0	15,0	10	603 508
10	11,0	17,5	5	603 510
12	15,0	23,0	5	603 513



Niederdruckschläuche Typ GCNA low pressure hoses type GCNA



Schlauchkonstruktion:

Schlauch aus synthetischem Gummi, ein Textilgeflecht und eine Umflechtung aus verzinktem Stahldraht

hose construction:

hose from synthetic rubber, a textile network and a braiding from galvanized steel wire

Anwendungs- und Temperaturbereich:

application and temperature range:

Superkraftstoffe/super fuels	+40°C
Dieselmotoren (DIN 51 601)/diesel fuels (DIN 51 601)	+80°C
Heizöl EL ,L (DIN 51 603)/fuel oil EL ,L (DIN 51 603)	+70°C
Wasser/water	+80°C
Luft/air	+70°C
Kältebeständigkeit/resistance to cold	-30°C

NW	Innen-Ø internal-Ø mm	Außen-Ø external-Ø mm	Biegeradius bend radius mm	Betriebsdruck working pressure bar	Berstdruck burst pressure bar	Prüfdruck test pressure bar	Art.-Nr.
2	4,5	10,5	40	30	90	45	601 702
4	5,5	11,5	40	30	90	45	601 704
6	7,5	13,5	50	30	90	45	601 706
8	9,5	16,5	60	25	75	38	601 708
10	11,0	18,5	70	25	75	38	601 710
12	15,0	24,0	85	25	75	38	601 713

Niederdruckschläuche Typ GCW low pressure hoses type GCW



Druck- und Vakuumschlauch pressure and vacuum hose

Schlauchkonstruktion:

Schlauchinnenschicht aus synthetischem Gummi, ein Textilgeflecht mit Stahldrahtwendel, ein Textilgeflecht

hose construction:

hose interior layer from synthetic rubber, a textile network with steel wire a textile network

Anwendungs- und Temperaturbereich:

application and temperature range:

Motorensmieröle (HD-Öle)/engine lubricating oils (HD-oils)	+80°C
Dieselmotoren/diesel fuels	+80°C
Heizöl EL ,L/fuel oil EL ,L	+70°C
Luft ölhaltig/oil containing air	+80°C
Hydraulikflüssigkeiten auf Mineral- und Glycolbasis/hydraulic fluids on mineral and glycol base	+80°C
pflanzliche Schmierfette/herbal greases	+80°C
Kältebeständigkeit/resistance to cold	-30°C

NW	Innen-Ø internal-Ø mm	Außen-Ø external-Ø mm	Biegeradius bend radius mm	Betriebsdruck working press. bar	Berstdruck burst press. bar	Prüfdruck test press. bar	Vakuum vacuum bar	Art.-Nr.
12	13,0	22,0	60	25	80	40	-0,80	601 813
16	16,0	25,0	90	15	50	25	-0,70	601 816
20	20,0	30,0	105	15	50	25	-0,65	601 820
25	25,0	35,5	120	15	50	25	-0,60	601 825
32	32,0	42,5	175	15	50	25	-0,90	601 832
40	40,0	51,5	270	10	30	15	-0,80	601 840
50	50,0	61,5	320	10	30	15	-0,70	601 850
60	60,0	72,5	360	10	30	15	-0,60	601 860

Niederdruckschläuche Typ GCWA low pressure hoses type GCWA

Druck- und Vakuumschlauch

pressure and vacuum hose

Schlauchkonstruktion:

Schlauchinnenschicht aus synthetischem Gummi, ein Textilgeflecht mit Stahldrahtwendel, ein Textilgeflecht und eine Umflechtung mit verzinktem Stahldraht

hose construction:

hose interior layer from synthetic rubber, a textile network with steel wire, a textile network and a braiding with galvanized steel wire

Anwendungs- und Temperaturbereich:

application and temperature range:

Motorschmieröle (HD-Öle)/engine lubricating oils (HD-oils)	+80°C
Dieseldieselkraftstoffe/diesel fuels	+80°C
Heizöle EL ,L/fuel oil EL ,L	+70°C
Luft ölhaltig/oil containing air	+80°C
Hydraulikflüssigkeiten auf Mineral- und Glycolbasis/hydraulic fluids on mineral and glycol base	+80°C
pflanzliche Schmierfette/herbal greases	+80°C
Kältebeständigkeit/resistance to cold	-30°C



NW NS	Innen-Ø internal-Ø mm	Außen-Ø external-Ø mm	Biegeradius bend radius mm	Betriebsdruck working press. bar	Berstdruck burst press. bar	Prüfdruck test press. bar	Vakuum vacuum bar	Art.-Nr.
12	13,0	23,0	70	35	100	55	-0,80	601 913
16	16,0	26,0	90	30	90	45	-0,70	601 916
20	20,0	31,5	105	25	75	38	-0,65	601 920
25	25,0	37,0	120	24	75	38	-0,60	601 925
32	32,0	44,0	175	22	70	35	-0,90	601 932
40	40,0	53,0	280	20	60	30	-0,80	601 940
50	50,0	63,0	335	18	60	30	-0,70	601 950
60	60,0	73,5	400	15	50	25	-0,60	601 960

Niederdruckschläuche Typ OLN low pressure hoses type OLN

Schlauchkonstruktion:

Schlauchinnenschicht aus synthetischem Gummi, ein bis zwei Textilgeflechte; abriebfeste, synthetische Gummiaußenschicht, ozon - und lichtrissbeständig

hose construction:

hose interior layer from synthetic rubber, one to two textile networks; resistant to friction, synthetic external rubber layer, ozone - and light-tear-steadily

Anwendungs- und Temperaturbereich:

application and temperature range:

Motorschmieröle (HD-Öle)/engine lubricating oils (HD-oils)	+100°C
Dieseldieselkraftstoffe/diesel fuels	+80°C
Heizöle EL ,L/fuel oil EL ,L	+70°C
Luft ölhaltig/oil containing air	+80°C
Hydraulikflüssigkeiten auf Mineral- und Glycolbasis/hydraulic fluids on mineral and glycol base	+100°C
pflanzliche Schmierfette/herbal greases	+80°C
Kältebeständigkeit/resistance to cold	-40°C
kurzzeitige Spitzentemperatur/temporary top-level temperature	+125°C

NW NS	Innen-Ø internal-Ø mm	Außen-Ø external-Ø mm	Biegeradius bend radius mm	Betriebsdruck working press. bar	Berstdruck burst press. bar	Prüfdruck test press. bar	Vakuum vacuum bar	Art.-Nr.
2	4,0	10,0	30	25	80	40	-0,90	602 002
4	6,0	12,0	40	25	80	40	-0,90	602 004
6	8,0	14,0	50	25	80	40	-0,90	602 006
8	9,0	15,0	50	25	80	40	-0,85	602 008
10	11,0	18,0	70	20	60	30	-0,80	602 010
12	13,0	22,0	90	20	60	30	-0,80	602 013
16	16,0	25,0	110	15	50	25	-0,70	602 016
20	20,0	30,0	130	12	40	20	-0,65	602 020



Niederdruckschläuche Typ OLNS 1 low pressure hoses type OLNS 1



Schlauchkonstruktion:

Schlauchinnenschicht aus synthetischem Gummi, ein bis zwei PA-Geflechte, ab DN 25 mit Stahldrahtwendel abriebfeste, synthetische Gummiaußenschicht, ozon - und lichtrissbeständig

hose construction:

hose interior layer from synthetic rubber, one to two PA-networks, starting from DN 25 with steel wire spiral, resistant to friction, synthetic external rubber layer, ozone - and light-tear-steadily

Anwendungs- und Temperaturbereich:

application and temperature range:

Motorschmieröle (HD-Öle)/engine lubricating oils (HD-oils)	+150°C
Dieselmotoren/diesel fuels	+80°C
Heizöle EL ,L/fuel oil EL ,L	+70°C
Luft ölhaltig/oil containing air	+80°C
Hydraulikflüssigkeiten auf Mineral- und Glycolbasis/hydraulic fluids on mineral and glycol base	+120°C
pflanzliche Schmierfette/herbal greases	+80°C
Kältebeständigkeit/resistance to cold	-35°C

NW NS	Innen-Ø internal-Ø mm	Außen-Ø external-Ø mm	Biegeradius bend radius mm	Betriebsdruck working pressure bar	Berstdruck burst pressure bar	Prüfdruck test pressure bar	Art.-Nr.
6	6,0	12,5	50	40	250	60	602 506
8	8,0	14,0	60	35	200	60	602 508
10	10,0	16,0	60	30	200	60	602 510
12	12,0	19,0	70	25	150	40	602 512
16	16,0	24,0	100	25	150	40	602 516
20	20,0	30,0	130	25	150	40	602 520
25	25,0	35,5	130	25	150	40	602 525

Niederdruckschläuche Typ KR low pressure hoses type KR

DIN 73379 2A
DIN 73379 2A

Schlauchkonstruktion:

Schlauchinnenschicht aus synthetischem Gummi, eine Textilgeflechteinlage, abriebfeste, glatte synthetische Gummi-Außenschicht, ozon- und lichtrissbeständig

hose construction:

hose interior layer from synthetic rubber, one textile network, resistant to friction, smooth synthetic external rubber layer, ozone – and light-tear-steadily

Anwendungs- und Temperaturbereich:

application and temperature range:

Kraftstoffe bis max. 50% Benzolgehalt/fuels to maximum 50% benzene content	+40°C
Superkraftstoffe/super fuels	+40°C
Dieselmotoren/diesel fuels	+80°C
Kühlstoffe (Glycol, Glysantin etc.)/Cooling materials (Glycol, Glysantin etc.)	+90°C
Wasser/Water	+80°C
Luft/air	+70°C
wässrige Lösungen ohne oxydierende Stoffe/waterily solutions without oxidizing materials	+80°C
Kältebeständigkeit/resistance to cold	-40°C
Kurzfristige Spitzentemperatur/temporary top-level temperature	+110°C

Nennweite nominal size	Innen-Ø internal-Ø mm	Außen-Ø external-Ø mm	Betriebsdruck working press. bar	Berstdruck burst press. bar	Art.-Nr.
1	3,5	9,5	10	30	602 601
2	4,5	10,5	10	30	602 602
4	5,5	11,5	10	30	602 604
6	7,5	13,5	10	30	602 606
8	9,0	15,0	10	30	602 608
10	11,0	18,0	10	30	602 610
12	14,0	22,0	10	30	602 612



Niederdruckschläuche Typ KR auf Spulen hoses type KR on coils

Schlauchkonstruktion sowie Anwendungs- und Temperaturbereich: siehe oben

hose construction as well as application and temperature range: see above

Nennweite nominal size	Innen-Ø internal-Ø mm	Außen-Ø external-Ø mm	Spulenlänge coil length m	Art.-Nr.
2	4,5	10,5	15	604 602
4	5,5	11,5	15	604 604
6	7,5	13,5	15	604 606
8	9,0	15,0	10	604 608
10	11,0	18,0	5	604 610
12	14,0	22,0	5	604 612



Niederdruckschläuche Typ KRS low pressure hoses type KRS



DIN 73379 1A
DIN 73379 1A

Schlauchkonstruktion:

Schlauchinnenschicht aus synthetischem Gummi, eine Textilgeflechteinlage, Schlauchdecke aus synthetischem Gummi

hose construction:

hose interior layer from synthetic rubber, one textile network, hose cover from synthetic rubber

Anwendungs- und Temperaturbereich:

application and temperature range:

Kraftstoffe bis max. 50% Benzolgehalt/fuels to maximum 50% benzene content	+40°C
Superkraftstoffe/super fuels	+40°C
Dieselmotoren/diesel fuels	+50°C
Kühlstoffe (Glycol, Glysantin etc.)/Cooling materials (Glycol, Glysantin etc.)	+50°C
Wasser/Water	+50°C
Luft/air	+50°C
wässrige Lösungen ohne oxydierende Stoffe/waterily solutions without oxidizing materials	+50°C
Kältebeständigkeit/resistance to cold	-40°C
Kurzfristige Spitzentemperatur/temporary top-level temperature	+70°C

Nennweite nominal size	Innen-Ø internal-Ø mm	Außen-Ø external-Ø mm	Betriebsdruck working press. bar	Berstdruck burst press. bar	Art.-Nr.
2	4,5	10,5	10	30	602 352
4	5,5	11,5	10	30	602 354
6	7,5	13,5	10	30	602 356
8	9,0	15,0	10	30	602 358

Niederdruckschläuche Typ KRS auf Spulen hoses type KRS on coils



Schlauchkonstruktion sowie Anwendungs- und Temperaturbereich: siehe oben

hose construction as well as application and temperature range: see above

Nennweite nominal size	Innen-Ø internal-Ø mm	Außen-Ø external-Ø mm	Spulenlänge coil length m	Art.-Nr.
2	4,5	10,5	15	604 352
4	5,5	11,5	15	604 354
6	7,5	13,5	15	604 356
8	9,0	15,0	10	604 358

Niederdruckschläuche Typ FPM/ECO low pressure hoses type FPM/ECO

für BIO-Diesel **DIN 73379 (3E)**
for bio diesel **DIN 73379 (3E)**

Schlauchkonstruktion:

Schlauchinnenschicht aus FPM, Zwischenschicht aus ECO, eine Poly-Aramidgeflechteinlage, ECO-Außenschicht, ozon-, öl- und lichtrissbeständig

hose construction:

hose interior layer from FPM, Intermediate layer from ECO, a Poly-Aramid network insert, ECO external layer, ozone-, oil and light-tear-steadily

Anwendungs- und Temperaturbereich:

application and temperature range:

Beständig gegen alle handelsüblichen Kraftstoffe, incl. RME (Rapsölmethylester) und Alkohol-Kraftstoff/steadily against all commercial fuels, inclusive RME (Rapeoilmethylester) and alcohol fuel

Kältebeständigkeit bis/cold-resistantness to

Kurzfristige Spitzentemperatur/temporary top-level temperature

+110°C

-30°C

+135°C



Nennweite nominal size	Innen-Ø internal-Ø mm	Außen-Ø external-Ø mm	Betriebsdruck working press. bar	Berstdruck burst press. bar	Art.-Nr.
4	5,5	11,5	6	35	602 404
6	7,3	13,3	6	35	602 406
8	9,3	15,3	6	35	602 408
10	11,3	18,0	6	35	602 410
12	12,0	19,0	6	35	602 413

Niederdruckschl. Typ FPM/ECO auf Spulen hoses type FPM/ECO on coils

Schlauchkonstruktion sowie Anwendungs- und Temperaturbereich: siehe oben

hose construction as well as application and temperature

range: see above

Nennweite nominal size	Innen-Ø internal-Ø mm	Außen-Ø external-Ø mm	Spulenlänge coil length m	Art.-Nr.
4	5,5	11,5	15	604 404
6	7,3	13,3	15	604 406
8	9,3	15,3	10	604 408
10	11,3	18,0	5	604 410
12	12,0	19,0	5	604 413



Leckölschläuche ECOLINE overflow oil hoses ECOLINE



für BIO-Diesel
for bio diesel

Schlauchkonstruktion:

Schlauchinnenschicht aus FPM (Viton), erste Lage aus ECO, ein Gewebe aus Aramid, Außendecke ECO

hose construction:

hose interior layer from FPM (Viton), first layer from ECO, a texture out of aramid, cover out of ECO

Nennweite nominal size	Innen-Ø internal-Ø mm	Außen-Ø external-Ø mm	Art.-Nr.
1	3,2	9,0	602 499

Leckölschläuche Typ DBK overflow oil hoses type DBK



für Düsenhalter
for nozzle holder

Schlauchkonstruktion:

Schlauch aus synthetischem Gummi, ein aufvulkanisiertes Textilgeflecht nach DIN 73379 B (gem. Ausgabe 1981)

hose construction:

hose interior layer from synthetic rubber, a up-vulcanized textile network, according to DIN 73379 B (Issue 1981)

Temperaturbereich: -30°C bis +80°C
temperature range: -30°C to +80°C

Nennweite nominal size	Innen-Ø internal-Ø mm	Außen-Ø external-Ø mm	Betriebsdruck working press. bar	Berstdruck burst press. bar	Art.-Nr.
1	3,2	7,0	10	30	601 550

Leckölschläuche Typ GCK overflow oil hoses type GCK



Schlauchkonstruktion:

Schlauch aus synthetischem Gummi, ein aufvulkanisiertes Textilgeflecht nach DIN 73379 B (gem. Ausgabe 1981)

hose construction:

hose interior layer from synthetic rubber, a up-vulcanized textile network, according to DIN 73379 B (Issue 1981)

Temperaturbereich: -30°C bis +80°C
temperature range: -30°C to +80°C

Nennweite nominal size	Innen-Ø internal-Ø mm	Außen-Ø external-Ø mm	Betriebsdruck working press. bar	Berstdruck burst press. bar	Art.-Nr.
1	3,0	7,0	10	30	601 501

Leckölschläuche Typ HNBR overflow oil hoses type HNBR

Schlauchkonstruktion:

Schlauchinnenschicht aus HNBR, eine Baumwoll-Textilumflechtung für Bio-Diesel geeignet

hose construction:

hose interior rubber from HNBR, a cotton textile braiding, suitable for bio diesel

Temperaturbereich: -40°C bis +100°C, kurzzeitig bis +125°C

temperature range: -40°C to +100°C, briefly up to +125°C

Nennweite nominal size	Innen-Ø internal-Ø mm	Außen-Ø external-Ø mm	Betriebsdruck working press. bar	Berstdruck burst press. bar	Art.-Nr.
1	3,0	6,8	10	30	601 600
1	3,2	7,0	10	30	601 600 01

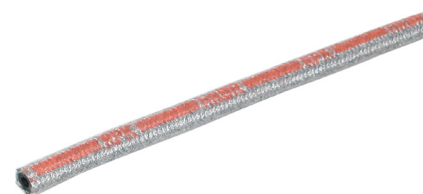

Niederdruckschläuche Typ KR low pressure hoses type KR

DIN 73379 (2A)

Schlauchkonstruktion:

Schlauchinnenschicht aus synthetischem Gummi, eine Textilgeflechteinlage, abriebfeste, glatte synthetische Gummi-Außenschicht, ozon- und lichtrissbeständig

hose construction:

hose interior from synthetic rubber, a textile network insert, resistant to friction, smooth synthetic external rubber layer, ozone- and light-tear-steadily

Nennweite nominal size	Innen-Ø internal-Ø mm	Außen-Ø external-Ø mm	Betriebsdruck working press. bar	Berstdruck burst press. bar	Art.-Nr.
1	3,2	9,0	10	30	602 300



Leckölschläuche auf Spulen overflow oil hoses on coils

Schlauchkonstruktion und Temperaturbereich: siehe oben

hose construction and temperature range: see above

Nennweite nominal size	Innen-Ø internal-Ø mm	Außen-Ø external-Ø mm	Schlauchtyp type of hose	Spulenlänge coil length m	Art.-Nr.
1	3,2	7,0	DBK	20	603 550
1	3,0	7,0	GCK	20	603 501
1	3,0	6,8	HNBR	20	603 600
1	3,2	7,0	HNBR	20	603 600 01
1	3,2	9,0	KR	20	604 300
1	3,2	9,0	ECOLINE	20	604 499



PVC-Schläuche Typ PL PVC hoses type PL



Schlauchkonstruktion:

Schlauch aus PVC glasklar

Anwendungsbereich:

Bedingt beständig gegen Chemikalien, Lösungsmittel, Öle und Fette, Benzin etc. Chemische Veränderungen des Weichmachers durch Chemikalien mit stärkerer Konzentration insbesondere bei höheren Temperaturen

hose construction:

hose from PVC highly transparently

range of application:

caused steadily against chemicals, solvents, oils and fats, gasoline etc. Chemical changes of the softener by chemicals with stronger concentration in particular at higher temperatures

Temperaturbereich: -10°C bis +60°C

temperature range: -10°C to +60°C

Nennweite nominal size	Innen-Ø internal-Ø mm	Außen-Ø external-Ø mm	Kurzzeitig belastbar bis Briefly loadable bar	Art.-Nr.
1	3,0	5,0	9,5	601 001
2	4,0	6,0	7,5	601 026
2	4,0	8,0	12,5	601 002
3	5,0	8,0	8,5	601 003
4	6,0	10,0	9,5	601 004
6	7,0	11,0	8,5	601 006
8	9,0	13,0	6,5	601 008
10	10,0	16,0	8,5	601 009
10	11,0	15,0	5,5	601 010
10	12,0	18,0	7,5	601 011
12	13,0	19,0	7,0	601 012
12	14,0	18,0	4,5	601 013
16	16,0	22,0	6,0	601 016
20	19,0	25,0	5,0	601 019
20	20,0	26,0	4,5	601 020
20	22,0	28,0	4,5	601 022
25	25,0	33,0	5,0	601 025
32	32,0	40,0	4,0	601 032
40	38,0	48,0	4,0	601 040
50	50,0	60,0	3,0	601 050

PVC-Schläuche Typ PL auf Spulen PVC hoses type PL on coils

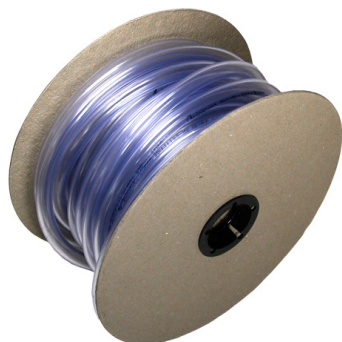

Schlauchkonstruktion sowie Anwendungs- und Temperatur-

bereich: siehe oben

hose construction as well as application and temperature range:

see above

Nennweite nominal size	Innen-Ø internal-Ø mm	Außen-Ø external-Ø mm	Spulenlänge coil length m	Art.-Nr.
1	3,0	5,0	15	603 001
2	4,0	8,0	15	603 002
3	5,0	8,0	15	603 003
4	6,0	10,0	15	603 004
6	7,0	11,0	15	603 006
8	9,0	13,0	15	603 008

PVC-Schläuche Typ A-PL PVC hoses type A-PL



Erfüllt die 2002/95/EC (RoHS) und 1907/2006/EC (Reach)

Schlauchkonstruktion:

Schlauch aus Weich-PVC mit zwischen Innenschlauch und Ummantelung verschiebungsfest eingebetteter Synthefaden-Armierung, glasklar

Anwendungsbereich:

Bedingt beständig gegen Chemikalien, Lösungsmittel, Öle und Fette, Benzin etc. Chemische Veränderungen des Weichmachers durch Chemikalien mit stärkerer Konzentration insbesondere bei höheren Temperaturen

Fulfilles 2002/95/EC (RoHS) and 1907/2006/EC (Reach)

hose construction:

hose from soft PVC with synthesis thread reinforcing, which is embodied between interior hose and cover, highly transparently

range of application:

caused steadily against chemicals, solvents, oils and fats, gasoline etc. chemical changes of the softener by chemicals with stronger concentration in particular at higher temperatures

Temperaturbereich: -20°C bis +65°C

temperature range: -20°C to +65°C

Nennweite nominal size	Innen-Ø internal-Ø mm	Außen-Ø external-Ø mm	Biegeradius bend radius mm	Betriebsdruck working pressure mm	Berstdruck burst pressure bat	Art.-Nr.
2	4,0	10,0	15	28	84	601 102
3	5,0	11,0	18	28	84	601 103
4	6,0	12,0	25	25	75	601 104
6	8,0	14,0	30	24	72	601 106
7	9,0	15,0	35	22	66	601 107
8	10,0	16,0	40	21	63	601 108
10	12,0	21,0	55	17	51	601 110
12	13,0	20,0	72	16	48	601 112
16	16,0	23,0	75	15	45	601 113
20	19,0	27,0	130	11	33	601 116
25	25,0	34,0	220	8	24	601 120
32	32,0	42,0	310	8	24	601 132
40	38,0	48,0	420	6	18	601 140
50	50,0	60,0	650	4	12	601 150

PVC-Schläuche Typ A-PL auf Spulen PVC hoses type A-PL on coils

Schlauchkonstruktion sowie Anwendungs- und Temperaturbereich: siehe oben

hose construction as well as application and temperature

range: see above

Nennweite nominal size	Innen-Ø internal-Ø mm	Außen-Ø external-Ø mm	Spulenlänge coil length m	Art.-Nr.
2	4,0	10,0	15	603 102
3	5,0	11,0	15	603 103
4	6,0	12,0	15	603 104
6	8,0	14,0	15	603 106
7	9,0	15,0	10	603 107
8	10,0	16,0	10	603 108



Schlauchkonstruktion:

Schlauch aus PVC mit synthetischen Garneinlagen, cadmiumfrei, farbig

Anwendungsbereich:

Druckluftschlauch für den allgemeinen Einsatz in der Industrie, hauptsächlich an hydraulischen Anlagen und Druckluftsystemen, im Caravanbau als Wasserschlauch, in der Schweißtechnik an MIG-Brennern, im Maschinenbau zur farblichen Unterscheidung einzelner Schlauchleitungen.

hose construction:

Hose made from PVC with synthetic twine inlet, free of cadmium, coloured

range of application:

Compressed air hose for the use of generally engineering, especially at hydraulic- and pneumatically systems, at caravans as water hose, at welding technology at MIG-burners, at the engine building to separate several hose lines.

Temperaturbereich: -20°C bis +65°C

temperature range: -20°C to +65°C

rot transparent/red transparent

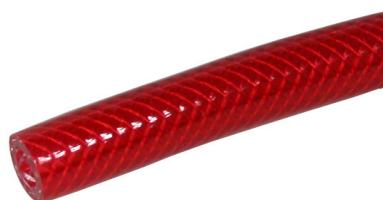

Innen-Ø internal-Ø mm	Außen-Ø external-Ø mm	Biegeradius bend radius mm	Betriebsdruck working pressure bar	Berstdruck burst pressure bar	Art.-Nr.
6,0	12	25	25	60	601 104 01
9,0	15	35	22	48	601 107 01
10,0	16	40	21	40	601 108 01
13,0	20	60	15	32	601 112 01
19,0	27	110	11	28	601 116 01

grün/green

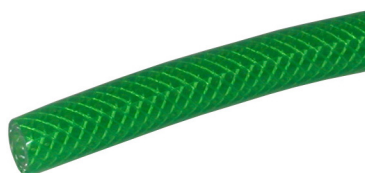

6,0	12	25	25	60	601 104 02
9,0	15	35	22	48	601 107 02
10,0	16	40	21	40	601 108 02
13,0	20	60	15	32	601 112 02

blau transparent/blue transparent



6,0	12	25	25	60	601 104 03
9,0	15	35	22	48	601 107 03
10,0	16	40	21	40	601 108 03
13,0	20	60	15	32	601 112 03
19,0	27	110	11	28	601 116 03

blau gedeckt/blue covered



6,0	12	25	15	60	601 104 04
9,0	15	35	12	48	601 107 04
10,0	16	40	10	40	601 108 04
13,0	20	60	8	32	601 112 04

schwarz/black



6,0	12	25	15	60	601 104 05
9,0	15	35	12	48	601 107 05
10,0	16	40	10	40	601 108 05
13,0	20	60	8	32	601 112 05

DIN 73411-79

Schlauchkonstruktion:

Seele: EPDM-Gummi, hitze- und kühlmittelbeständig
 Einlage: hochzugfeste synthetische Textileinlage
 Decke: hitze-, alterungs- und witterungsbeständiger EPDM-Gummi

hose construction:

inner layer: EPDM-rubber, heat- and refrigerant-resistant
 reinforcement: highly longitudinal strength synthetic textile network
 cover: heat-, age- and weather resistant EPDM-rubber

Temperaturbereich: -40°C bis +125°C

temperature range: -40°C to +125°C

Rollenlängen: 40 m, ab Innen-Ø 63 mm 1 m Stücke

coil lengths: 40 m, starting from inside-Ø of 63mm 1 m pieces



Innen-Ø internal-Ø mm	Außen-Ø external-Ø mm	Betriebsdruck working press. bar	Berstdruck burst pressure bar	Bezeichnung description	Art.-Nr.
8	15	5	15	KS 08	650 408
10	16	5	15	KS 10	650 410
12	19	5	15	KS 12	650 412
13	20	5	15	KS 13	650 413
15	22	5	15	KS 15	650 415
16	23	5	15	KS 16	650 416
18	25	5	15	KS 18	650 418
19	26	5	15	KS 19	650 419
20	27	5	15	KS 20	650 420
22	29	5	15	KS 22	650 422
25	32	5	15	KS 25	650 425
28	36	5	15	KS 28	650 428
30	38	4	12	KS 30	650 430
32	40	4	12	KS 32	650 432
35	44	4	12	KS 35	650 435
38	48	4	12	KS 38	650 438
40	50	4	12	KS 40	650 440
42	52	4	12	KS 42	650 442
45	55	4	12	KS 45	650 445
48	58	4	12	KS 48	650 448
50	60	4	12	KS 50	650 450
55	65	4	12	KS 55	650 455
60	70	4	12	KS 60	650 460
63	73	4	12	KS 63	650 463
65	75	4	12	KS 65	650 465
70	80	4	12	KS 70	650 470
75	85	4	12	KS 75	650 475
80	92	4	12	KS 80	650 480
85	97	4	12	KS 85	650 485
90	102	4	12	KS 90	650 490
100	112,5	4	12	KS 100	650 500
105	117	4	12	KS 105	650 505
110	122	4	12	KS 110	650 510
114	126	4	12	KS 114	650 514
120	133	4	12	KS 120	650 520
125	138	4	12	KS 125	650 525
140	153	4	12	KS 140	650 540
150	164	4	12	KS 150	650 550

Faltenschläuche TUBANO pleated hoses TUBANO



Schlauchkonstruktion:

Synthetischer Gummi, Typ EPT, Qualität 78010

hose construction:

synthetic rubber, type EPT, quality 78010

Temperaturbereich: -40°C bis +135°C

temperature range: -40°C to +135°C

Lieferlängen: 1 m

Delivery length: 1 m

Achtung: Nur für kurzfristige Anwendungen bei Reparaturen einsetzbar!

note: Only for short term applications with repair applicable!

Innen-Ø internal-Ø mm	Biegeradius bend radius mm	Betriebsdruck max. bei +30° working pressure max. at +30°C bar	Bezeichnung description	Art.-Nr.
20-25	70	1,5	Tubano 20	650 320
25-31	85	1,5	Tubano 25	650 325
31,5-36	105	1,5	Tubano 31,5	650 331
33,5-38	110	1,5	Tubano 33,5	650 333
37-44	115	1,5	Tubano 37	650 337
44-48	120	1,5	Tubano 44	650 344
48-55	125	1,5	Tubano 48	650 348
55-65	130	1,5	Tubano 55	650 355
65-75	140	1,5	Tubano 65	650 365
80-90	300	1,5	Tubano 80	650 380

Sortiment Faltenschläuche TUBANO assortment pleated hoses TUBANO

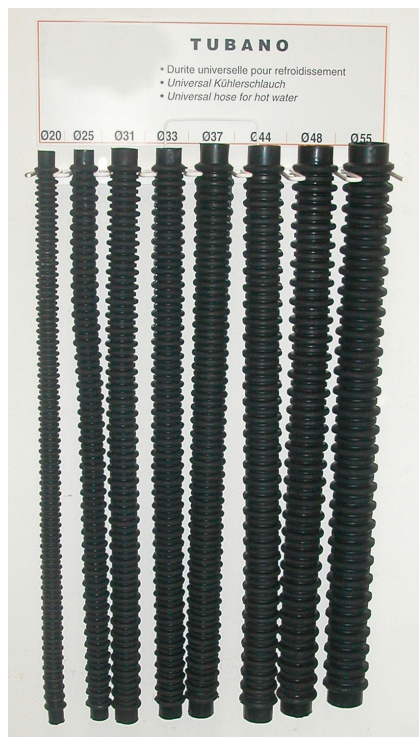

**mit Wandaufhänger
with wall hanger**

Schlauchkonstruktion und Temperaturbereich: siehe oben

hose construction and temperature range: see above

Lieferumfang: 8 Stück Tubano Kühlwasserschläuche

Größen: 20, 25, 31, 33, 37, 44, 48 u. 55

scope of supply: 8 pieces Tubano pleated hoses

sizes: 20, 25, 31, 33, 37, 44, 48 and 55

Bezeichnung description	Art.-Nr.
20-55	650 301

PVC Saug- und Druckschläuche PVC suction and pressure hoses

Schlauchkonstruktion:

flexibler, formstabiler Spiralsaug- und Druckschlauch aus Weich-PVC, mittelschwere Ausführung, grün-transparent, innen glatt mit eingebetteter weißer Hart-PVC-Spirale, außen leicht gewellt

hose construction:

flexible, form-stable spiral suction and pressure hose from soft PVC, moderately severe execution, green transparency, inside smoothly with embedded white hard PVC spiral, external easily curved

Temperaturbereich: -10°C bis +60°C

temperature range: -10°C to +60°C

Geeignet für Frischwasser, Seewasser, ölhaltiges Wasser, Schmutzwasser und Gülle
Suitable for fresh water, sea water, oily water, waste water, and liquid manure



Innen-Ø internal-Ø mm	Wandstärke wall thickness mm	Außen-Ø external-Ø mm	Betriebsdruck working pressure bar	Biegeradius bend radius mm	Vakuum vacuum m/WS	Art.-Nr.
19	2,4	23,8	5	110	6	680 619
25	2,5	30,0	5	140	6	680 625
30	2,6	35,2	5	160	6	680 630
32	2,6	37,2	5	180	6	680 632
38	3,0	44,0	5	210	6	680 638
40	3,2	46,4	5	220	6	680 640
45	3,2	51,4	5	240	6	680 645
51	3,6	57,2	5	270	6	680 650
60	3,6	67,2	5	330	6	680 660
63	3,7	70,4	5	350	6	680 663
70	3,9	77,8	4	450	6	680 670
76	4,1	84,1	4	500	6	680 676
80	4,5	89,0	4	500	6	680 680
90	5,3	100,6	4	500	6	680 690
102	5,7	111,4	4	500	6	680 700

Kupferrohre copper tubes

Werkstoff: Kupfer

material: copper

Lieferlängen: 10 m Rollen, ab Außen-Ø 10 mm 20 m Rollen

Delivery length: 10 m coils, starting from outside-Ø 10 mm 20 m coils

Außen-Ø external-Ø mm	Wandstärke wall thickness mm	Betriebsdruck max. working pressure max bar	Bezeichnung description	Art.-Nr.
4	0,6	128	Kupferrohr 4X0,8mm	320 054
5	0,8	138	Kupferrohr 5X0,8mm	320 055
6	0,8	112	Kupferrohr 6X0,8mm	320 056
8	0,8	81	Kupferrohr 8X0,8mm	320 058
10	0,7	62	Kupferrohr 10X0,7mm	320 060
12	0,8	67	Kupferrohr 12X0,8mm	320 062
4	1	128	Kupferrohr 4X1,0mm	320 004
5	1	138	Kupferrohr 5X1,0mm	320 005
6	1	112	Kupferrohr 6X1,0mm	320 006
8	1	81	Kupferrohr 8X1,0mm	320 008
9	1	62	Kupferrohr 9X1,0mm	320 009
10	1	62	Kupferrohr 10X1,0mm	320 010
12	1	67	Kupferrohr 12X1,0mm	320 012

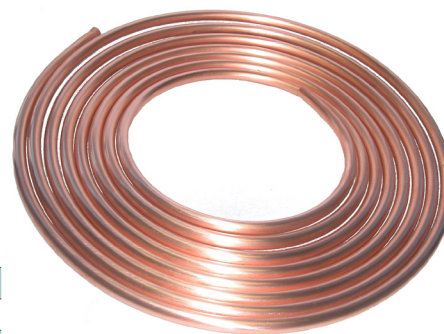



Schlauchkonstruktion:

Stabiler, hochflexibler, transparenter, glatter und toxidfreier plastifizierter PVC-Schlauch mit einer Verstärkungsspirale aus schlag- und druckfestem galvanisiertem Stahl.

Anwendungsbereich:

Zum Umfüllen von Wasser, Getränken, Mineralwasser und Fruchtsäften, besonders auch einsetzbar im Schiffbau, Werften, Entwässerungen, Saugpumpen, Lebensmittelindustrie, Landwirtschaft oder an Arbeitsmaschinen.

hose construction:

Stable, high-flexible, transparent, smooth and free of toxide PVC-hose with an backing spiral made from impact- and pressure-resistant galvanised steel.

range of application:

For decanting water, soft drinks, mineral water and fruit juices, especially applicable at the shipbuilding, dockyards, drainage, suction pumps, food industrie, agriculture or at work machines.

Temperaturbereich: -5°C bis +60°C

temperature range: -5°C to +60°C

Innen-Ø internal-Ø mm	Biegeradius bend radius mm	Berstdruck burst pressure bar	Vakuum vacuum m/H ₂ O	Art.-Nr.
8	20	21	9	680 808
10	20	21	9	680 810
12	25	21	9	680 812
14	30	18	9	680 814
16	35	18	9	680 816
18	40	18	9	680 818
20	50	15	9	680 820
25	60	15	9	680 825
30	70	13	9	680 830
32	75	13	9	680 832
35	80	12	9	680 835
38	90	12	9	680 838
40	95	9	9	680 840
45	105	9	8	680 845
51	125	9	8	680 851
60	135	7	7	680 860
63	150	7	7	680 863
70	180	6	7	680 870
76	195	6	7	680 876
80	220	6	7	680 880
90	260	6	6	680 890
102	300	6	6	680 902
105	315	6	6	680 905
114	345	6	6	680 914
127	385	6	6	680 927
152	460	6	6	680 952

Silikon Gewebesläuche silicon reinforcement hoses

Schlauchkonstruktion:

Druckfester Schlauch aus Silikon mit diagonal eingebetteter Glasseidenfaden-Armierung, glasklar

Anwendungsbereich:

Zum Durchleiten von Getränken und alkoholhaltigen Flüssigkeiten bis 96 vol. % und flüssigen Nahrungsmitteln, sowie aggressiven Chemikalien in der Medizintechnik oder Kosmetikindustrie, dampfsterilisierbar bei 134°C

hose construction:

Pressure resistant hose from silicone with diagonal embodied glass fibre reinforcing, highly transparently, steam sterilisation at 134°C possible

range of application:

For transporting drinks and alcoholic liquids up to 96 vol. % and liquid foodstuffs, as well as aggressive chemicals at the medical technology or the cosmetics industry

Temperaturbereich: -60°C bis +200°C

temperature range: -60°C to +200°C

Innen-Ø internal-Ø mm	Außen-Ø external-Ø mm	Biegeradius bend radius mm	Betriebsdruck working pressure bar	Berstdruck burst pressure bar	Art.-Nr.
3,0	9,0	15	20	60	605 003
4,0	10,0	20	20	60	605 004
5,0	11,0	25	12	36	605 005
6,0	12,0	30	10	30	605 006
8,0	15,0	40	8	24	605 008
10,0	17,0	50	8	24	605 010
12,5	19,5	55	7	21	605 012
14,0	21,0	60	6	18	605 014
16,0	26,0	75	6	18	605 016
19,0	30,0	100	5	15	605 019
25,0	37,0	180	3	9	605 025



Polyurethan Druckluftschläuche compressed air hoses from polyurethane

Schlauchkonstruktion:

2-lagiger formstabiler Polyurethan Schlauch mit Fadenarmierung

Anwendungsbereich:

Druckluftschlauch mit guter Beständigkeit gegen Öle, Benzine und Fette beispielsweise als Druckluftschlauch für Autolackierereien oder in der Mess- und Regeltechnik

hose construction:

Dimensionally stable polyurethane hose with fibre reinforcement

range of application:

Compressed air hose with good resistance to oil, benzine and fats for example as compressed air hose for paint shops or in the measuring and control technology

Temperaturbereich: -40°C bis +80°C

temperature range: -40°C to +80°C

Innen-Ø internal-Ø mm	Außen-Ø external-Ø mm	Biegeradius bend radius mm	Betriebsdruck working pressure bar	Berstdruck burst pressure bar	Art.-Nr.
6,0	10,0	15,0	20	60	605 090
9,0	14,0	30,0	20	60	605 091
13,0	18,0	40,0	16	48	605 092



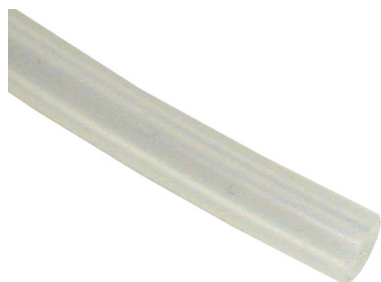

Schlauchkonstruktion:

transparenter Silikon Schlauch, innen und außen glatt, Härte 60 Shore

Anwendungsbereich:

Zum drucklosen Durchleiten von Getränken und alkoholhaltigen Flüssigkeiten, sowie aggressiven Chemikalien in der Medizintechnik oder Kosmetikindustrie, beständig gegen Heißluft

hose construction:

Transparently hose from silicone, inside and outside smoothly, hardness 60 Shore

range of application:

For transporting drinks and alcoholic liquids, as well as aggressive chemicals at the medical technology or the cosmetics industry, resistant to hot air

Temperaturbereich: -60°C bis +200°C

temperature range: -60°C to +200°C

Innen-Ø internal-Ø mm	Außen-Ø external-Ø mm	Art.-Nr.
1,0	3,0	605 061
2,0	4,0	605 062
3,0	5,0	605 063
3,0	6,0	605 064
4,0	6,0	605 065
4,0	7,0	605 066
5,0	8,0	605 067
5,0	9,0	605 068
6,0	9,0	605 069
6,0	10,0	605 070
7,0	11,0	605 071
8,0	12,0	605 072
9,0	13,0	605 073
10,0	14,0	605 074
12,0	16,0	605 075
15,0	19,0	605 076
20,0	24,0	605 077
25,0	33,0	605 078

Schlauchkonstruktion:

Schlauch mit glatter, porenfreier NBR-Innenschicht und mit ozon-, witterungs- und UV-Strahlungsbeständiger sowie abriebfester NBR-Außenschicht

Anwendungsbereich:

Durch seine Unempfindlichkeit gegenüber Ozon, Witterung und UV-Strahlung sowie seine Abriebfestigkeit und der glatten, homogenen und geschmacks- und geruchsneutralen Innenschicht eignet sich der Lactopal-Schlauch besonders zum Einsatz in Lebensmittel-, pharmazeutischen und kosmetischen Industrie und ist beständig gegen übliche Reinigungs- und Desinfektionsmittel. Speziell für den rauen Betriebsalltag wurde der Schlauch äußerst robust, formstabil und überfahrbar konzipiert.

hose construction:

hose with smooth, non-porous internal layer made of NBR and ozone-, weather- and UV resistance as well as abrasion resistance external layer made of NBR

range of application:

Through his high resistance against ozone, weather and UV radiation as well as abrasion resistance together with the smooth, homogenous, tasteless and odorless internal layer the Lactopal suits especially for applications in the food, pharmaceutical and cosmetic industry and is resistant against usual detergents and disinfectant. Especially for the rough daily routine the hose was designed highly tough, dimensionally stable and able to drive over.

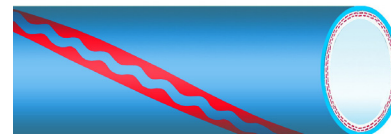

Temperaturbereich: -35°C bis +80°C, dämpfbar bis +110°C
temperature range: -35°C to +80°C, can be steamed up to +110°C

Innen-Ø internal-Ø mm	Außen-Ø external-Ø mm	Biegeradius bend radius mm	Betriebsdruck working pressure bar	Berstdruck burst pressure bar	Art.-Nr.
13,0	21,0	80	16	48	605 713
16,0	24,0	100	16	48	605 716
19,0	29,0	115	16	48	605 719
25,0	37,0	150	16	48	605 725
32,0	48,0	195	16	48	605 732
38,0	56,0	230	16	48	605 738
40,0	58,0	240	16	48	605 740
50,0	70,0	300	16	48	605 750
60,0	80,0	420	16	48	605 760
65,0	89,0	455	16	48	605 765
75,0	99,0	525	16	48	605 775
80,0	108,0	560	16	48	605 780
100,0	130,0	700	16	48	605 800

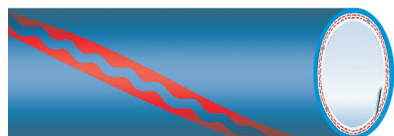

Schlauchkonstruktion:

Schlauch mit glatter, porenfreier NBR-Innenschicht und mit ozon-, witterungs- und UV-Strahlungsbeständiger sowie abriebfester NBR-Außenschicht

Anwendungsbereich:

Durch seine Unempfindlichkeit gegenüber Ozon, Witterung und UV-Strahlung sowie seine Abriebfestigkeit und der glatten, homogenen und geschmacks- und geruchsneutralen Innenschicht eignet sich der Lactopal-Schlauch besonders zum Einsatz in Lebensmittel-, pharmazeutischen und kosmetischen Industrie und ist beständig gegen übliche Reinigungs- und Desinfektionsmittel. Durch die eingearbeitete Stahldrahtwendel ist der Schlauch besonders leicht, flexibel und saugfest.

hose construction:

hose with smooth, non-porous internal layer made of NBR and ozone-, weather- and UV resistance as well as abrasion resistance external layer made of NBR

range of application:

Through his high resistance against ozone, weather and UV radiation as well as abrasion resistance together with the smooth, homogenous, tasteless and odorless internal layer the Lactopal suits especially for applications in the food, pharmaceutical and cosmetic industry and is resistant against usual detergents and disinfectant. By the use of the steel wire spiral becomes the hose especially light, flexible and suction solid.

Temperaturbereich: -35°C bis +80°C, dämpfbar bis +110°C
temperature range: -35°C to +80°C, can be steamed up to +110°C

Innen-Ø internal-Ø mm	Außen-Ø external-Ø mm	Biegeradius bend radius mm	Betriebsdruck working pressure bar	Berstdruck burst pressure bar	Art.-Nr.
19,0	29,0	60	16	48	605 819
25,0	37,0	80	16	48	605 825
32,0	44,0	100	16	48	605 832
38,0	51,0	115	16	48	605 838
40,0	54,0	130	16	48	605 840
50,0	66,0	150	16	48	605 850
53,0	67,0	160	16	48	605 853
60,0	74,0	170	16	48	605 860
63,0	77,0	180	16	48	605 863
65,0	81,0	190	16	48	605 865
75,0	91,0	225	16	48	605 875
80,0	96,0	300	16	48	605 880
100,0	118,0	350	16	48	605 900

Schlauchkonstruktion:

Schlauch aus NBR mit synthetischen Garneinlagen

Anwendungsbereich:

Durch seine Unempfindlichkeit gegenüber Ozon, Witterung und UV-Strahlung sowie seine Abriebfestigkeit eignet sich der TRIX-Blaustrahl besonders zum Einsatz in Industrie, Bergbau, Steinbrüchen, Hoch- und Tiefbau, Hüttenindustrie, Werften, Druckluftgeräte- und Kompressorherstellung, Tankstellen, Großgaragen und vielen anderen Bereichen.

hose construction:

Hose made from NBR with synthetic twine inlet

range of application:

Through its high resistance against ozone, weather and UV radiation as well as its abrasion resistance the TRIX-Blaustrahl suits especially for applications in industry, mining, stone pits, civil engineering, iron and steel industry, shipyards, compressed air units- and compressor manufacturing, gas stations, garages and many other fields.

Temperaturbereich: -40°C bis +70°C

temperature range: -40°C to +70°C



Innen-Ø internal-Ø mm	Außen-Ø external-Ø mm	Biegeradius bend radius mm	Betriebsdruck working pressure bar	Berstdruck burst pressure bar	Art.-Nr.
5,0	14,0	25	25	100	605 105
6,0	15,0	30	25	100	605 106
10,0	20,0	50	25	100	605 110
13,0	23,0	65	25	100	605 112
13,0	25,0	65	25	100	605 113
15,0	25,0	75	25	100	605 114
15,0	27,0	75	25	100	605 115
19,0	29,0	95	25	100	605 118
19,0	31,0	95	25	100	605 119
25,0	39,0	125	25	100	605 125
28,0	44,0	170	16	64	605 128
32,0	48,0	200	16	64	605 132
35,0	51,0	220	16	64	605 135
38,0	54,0	240	16	64	605 138
42,0	60,0	330	16	64	605 142

Goldschlange golden snake



Schlauchkonstruktion:

Schlauch mit glatter EPDM-Innenschicht und CR-Außenschicht, mit synthetischen Garneinlagen

Anwendungsbereich:

Hochleistungs Wasser- und Reinigungsschlauch für anspruchsvolle Anwendungen am Bau, im Freiland und an Maschinen, Apparaten und Behältern.

hose construction:

Hose with smooth EPDM internal layer and CR cover, with synthetic twine inlet

range of application:

High performance water- and cleaning hose for demanding application at building, outside and at machines, and reservoirs.

Temperaturbereich: -30°C bis +100°C, dämpfbar bis +130°C

temperature range: -30°C to +100°C, can be steamed up to +130°C

Innen-Ø internal-Ø mm	Außen-Ø external-Ø mm	Biegeradius bend radius mm	Betriebsdruck working pressure bar	Berstdruck burst pressure bar	Art.-Nr.
10,0	17,2	45	30	90	605 160
13,0	20,8	50	30	90	605 163
16,0	23,2	70	25	75	605 166
19,0	27,8	80	25	75	605 169
22,0	31,0	100	20	60	605 172
25,0	34,0	110	20	60	605 175
32,0	43,0	175	12	36	605 182
38,0	51,0	250	12	36	605 188
45,0	60,0	290	10	30	605 195
50,0	65,0	300	10	30	605 200

Universal Wasserschläuche universal water hoses



Schlauchkonstruktion:

Schlauch mit glatter EPDM-Innenschicht und CR-Außenschicht, mit synthetischen Garneinlagen,

Anwendungsbereich:

Hochleistungs Wasser- und Reinigungsschlauch für anspruchsvolle Anwendungen am Bau, im Freiland und an Maschinen, Apparaten und Behältern.

hose construction:

Hose with smooth EPDM internal layer and CR cover, with synthetic twine inlet

range of application:

High performance water- and cleaning hose for demanding application at building, outside and at machines, and reservoirs.

Temperaturbereich: -30°C bis +100°C, dämpfbar bis +130°C

temperature range: -30°C to +100°C, can be steamed up to +130°C

Innen-Ø internal-Ø mm	Außen-Ø external-Ø mm	Biegeradius bend radius mm	Betriebsdruck working pressure bar	Berstdruck burst pressure bar	Art.-Nr.
13,0	19,4	130	30	90	605 913
19,0	27,4	190	25	75	605 919
25,0	34,0	254	20	60	605 925
32,0	43,0	320	30	90	605 932

Schlauchkonstruktion:

Schlauch mit glatter EPDM-Innenschicht und EPDM-Außenschicht, mit synthetischen Garneinlagen

Anwendungsbereich:

Wasserschlauch für den Einsatz in gewerblichen und kommunalen Betrieben, im Hoch- und Tiefbau, in der Industrie, im Landschafts- und Gartenbau sowie in der Landwirtschaft und vielen anderen Bereichen. Durch seine Konstruktion ist er hochflexibel, robust, ozon- und witterungsbeständig.

hose construction:

Hose with smooth EPDM internal layer and EPDM cover, with synthetic twine inlet

range of application:

Water hose for the industrial- and communal- companies, civil engineering, industry, landscaping and gardening as well as for agriculture. Through its construction the TRIX-Rotstrahl is highly flexible, robust, ozone- and weather resistant.

Temperaturbereich: -40°C bis +100°C

temperature range: -40°C to +100°C

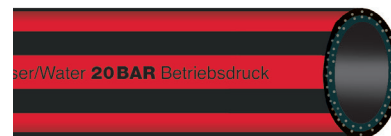

Innen-Ø internal-Ø mm	Außen-Ø external-Ø mm	Biegeradius bend radius mm	Betriebsdruck working pressure bar	Berstdruck burst pressure bar	Art.-Nr.
13,0	19,0	46	20	60	605 213
16,0	23,0	60	20	60	605 216
19,0	27,0	65	20	60	605 219
22,0	31,0	70	20	60	605 222
25,0	34,0	110	20	60	605 225
28,0	38,0	120	15	45	605 228
30,0	41,0	140	15	45	605 230
32,0	43,0	150	15	45	605 232
35,0	46,0	180	15	45	605 235
38,0	50,0	200	15	45	605 238
40,0	52,0	240	15	45	605 240
42,0	54,0	250	10	30	605 242
50,0	64,0	300	10	30	605 250

N20 KTW "A", DVGW - W 270
 GW Reg-Nr: DW-0309BT0079



Schlauchkonstruktion:

Schlauch mit plastomer- und weichmacherfreier Innenschicht und abrieb-, UV-, fett- und ölbeständiger NBR-Außenschicht, mit synthetischen Garneinlagen

Anwendungsbereich:

Trinkwasserschlauch für die Getränke- und Lebensmittelindustrie, Caravanbedarf, Großküchen, sowie zur Befüllung von Trinkwasserbehältern, für kommunale Notversorgungsleitungen oder Veranstaltungen im Freien. Die transparente Innenschicht ist absolut geschmacks- und geruchs-neutral. Der Aquapal erfüllt alle in Deutschland vorgeschriebenen Empfehlungen/ Normen zur Trinkwasserbeförderung.

hose construction:

Hose with plastomere- and flexibiliser-free internal layer and abrasions-, UV-, fat- and oilresistant NBR cover, with synthetic twine inlet

range of application:

Drinking water hose for the soft drink- and food industry, the caravan requirement, catering establishment, as well as for filling drinking water canisters, for communal emergency supply or outside events. The transparent internal layer is absolutely tasteless and unscented. The Aquapal achieves all in Germany mandatory recommendations/standards for transporting drinking water.

Temperaturbereich: -30°C bis +100°C, dämpfbar bis +130°C

temperature range: -30°C to +100°C, can be steamed up to +130°C

Innen-Ø internal-Ø mm	Außen-Ø external-Ø mm	Biegeradius bend radius mm	Betriebsdruck working pressure bar	Berstdruck burst pressure bar	Art.-Nr.
4,0	9,0	25	20	60	605 304
8,0	14,0	50	20	60	605 308
10,0	17,2	60	20	60	605 310
13,0	20,2	75	20	60	605 313
16,0	23,2	95	20	60	605 316
19,0	27,4	90	20	60	605 318
19,0	31,0	130	20	60	605 319
22,0	31,0	145	20	60	605 322
25,0	34,0	115	20	60	605 324
25,0	37,0	280	20	60	605 325
25,0	43,0	160	20	60	605 331
32,0	44,0	330	20	60	605 332
38,0	51,0	390	20	60	605 338
45,0	60,0	435	20	60	605 345
50,0	65,0	250	20	60	605 350
75,0	80,0	375	20	60	605 375
100,0	116,0	500	20	60	605 400

Dampf TRIX 5000

Schlauchkonstruktion:

Schlauch mit glatter EPDM-Innenschicht und EPDM-Außenschicht, mit hochfesten synthetischen Garneinlagen

Anwendungsbereich:

Schlauch der die höchsten Anforderungen an Heißwasser und Dampf führende Schlauchleitungen erfüllt. Er findet unter anderem Anwendung in der chemischen- bzw. petrochemischen Industrie, im Baugewerbe, Gartenbaubetrieben, zur Aufheizung von Kesselwagen und für sonstige anspruchsvolle Anwendungen. Durch seine Konstruktion ist er abriebfest, UV-, ozon- und witterungsbeständig.

hose construction:

Hose with smooth EPDM internal layer and EPDM cover, with high-tensile synthetic twine inlet

range of application:

Hose for the highest requirements to hot water and steam transporting hoses. It is used for among other things the chemistry and petrochemistry industry, the building sector, gardening companies, for heating road tanker and for other demanding applications. Through its construction the Dampf TRIX 5000 is abrasion resistant, UV-, ozone- and weather resistant.

Temperaturbereich: Heißwasser bis +120°C, Dampf (nur im offenen System) bis +164°C
temperature range: hot water up to +120°C, steam (just in open system) up to +164°C

Innen-Ø internal-Ø mm	Außen-Ø external-Ø mm	Biegeradius bend radius mm	Betriebsdruck working pressure bar	Berstdruck burst pressure bar	Art.-Nr.
13,0	25,0	130	6	60	605 413
19,0	33,0	190	6	60	605 419
25,0	40,0	250	6	60	605 425



Dampf TRIX 6000

Schlauchkonstruktion:

Schlauch mit glatter optimierter EPDM-Innenschicht und EPDM-Außenschicht, mit hochfesten synthetischen Garneinlagen

Anwendungsbereich:

Hochtemperaturbeständiger Schlauch für den zuverlässigen und sicheren Einsatz beim Transport von Heißdampf in der chemischen und petrochemischen Industrie, in Raffinerien, dem Baugewerbe, der Schifffahrt und für viele andere industrielle Anwendungen. Der Transport von reinem gesättigtem Wasserdampf ist ebenfalls möglich. Durch seine Konstruktion ist er abriebfest, UV-, ozon- und witterungsbeständig.

hose construction:

Hose with smooth optimised EPDM internal layer and EPDM cover, with high-tensile synthetic twine inlet

range of application:

High temperature resistant hose for a reliable and safe usage for transporting hot steam at the chemistry and petrochemistry industry, in refineries, the building sector, in shipping and many other industrial applications. The transport of clear saturated steam is also possible. Through its construction the Dampf TRIX 6000 is abrasion resistant, UV-, ozone- and weather resistant.

Temperaturbereich: Dampf bis +210°C bei 18 bar, kurzfristig sogar bis +220°C bei 23 bar
temperature range: steam up to +210°C at 18 bar, temporary up to +220°C at 23 bar

Innen-Ø internal-Ø mm	Außen-Ø external-Ø mm	Biegeradius bend radius mm	Betriebsdruck working pressure bar	Berstdruck burst pressure bar	Art.-Nr.
13,0	25,0	130	18	180	605 463
16,0	29,0	160	18	180	605 466
19,0	33,0	190	18	180	605 469
25,0	40,0	250	18	180	605 475
32,0	48,0	320	18	180	605 482
38,0	54,0	380	18	180	605 488
50,0	68,0	500	18	180	605 500



UNITRIX 60



Schlauchkonstruktion:

Schlauch mit glatter NBR-Innenschicht und NBR-Außenschicht, mit synthetischen Garneinlagen

Anwendungsbereich:

Vielzweckschlauch für den Maschinenbau, die Land- und Forstwirtschaft, Werkstätten, Steinbrüche, Bau sowie Schifffahrt und Bahn. Er findet unter anderem Anwendung in der chemischen- bzw. petrochemischen Industrie, an Kompressoren, Faßpumpen oder im Bereich der Mineralölindustrie. Er ist beständig gegen Benzin, Mineralöl, Kerosin, Gasöl, Heiz- und Schmieröl, Pressluft, Kalt- und Heißwasser, auch mit Waschzusätzen, pflanzliche Öle, tierische Fette, Alkohole, Schädlingsbekämpfungsmittel, Salzlösungen, Naphtha und vieles mehr. Durch seine Konstruktion ist er hoch flexibel, robust, öl-, fett-, und chemikalienbeständig

hose construction:

Hose with smooth NBR internal layer and NBR cover, with synthetic twine inlet

range of application:

Multipurpose hose for machine building industry, agriculture and forestry, garages, pits, building sector as well as shipping and railway. It is used among other things in the chemistry and petrochemistry industry, at compressors, drum pumps or in the mineral oil industry. It is resistant to benzene, mineral oil, kerosene, gas oil, fuel- and lube oil, compressed air, cold and hot water, also with cleaner, vegetable oils, animalistic fats, alcohol, biocides, saline solutions, naphtha and many more. Through its construction the Unitrix 60 is high flexible, robust, oil-, fat- and chemical resistant.

Temperaturbereich: -25°C bis +85°C

temperature range: -25°C to +85°C

Innen-Ø internal-Ø mm	Außen-Ø external-Ø mm	Biegeradius bend radius mm	Betriebsdruck working pressure bar	Berstdruck burst pressure bar	Art.-Nr.
6,0	13,0	35	20	60	605 256
8,0	15,5	50	20	60	605 258
10,0	17,5	60	20	60	605 260
13,0	21,0	80	20	60	605 263
16,0	25,0	100	20	60	605 266
19,0	29,0	120	20	60	605 269
25,0	36,0	150	20	60	605 275

Schlauchkonstruktion:

Schlauch mit glatter NBR-Innenschicht und NBR-Außenschicht, mit synthetischen Garneinlagen

Anwendungsbereich:

Vielweckschlauch für den Maschinenbau, die Land- und Forstwirtschaft, Werkstätten, Steinbrüche, Bau sowie Schifffahrt und Bahn. Er findet unter anderem Anwendung in der chemischen- bzw. petrochemischen Industrie, an Kompressoren, Faßpumpen oder im Bereich der Mineralölindustrie. Er ist beständig gegen Benzin, Mineralöl, Kerosin, Gasöl, Heiz- und Schmieröl, Pressluft, Kalt- und Heißwasser, auch mit Waschzusätzen, pflanzliche Öle, tierische Fette, Alkohole, Schädlingsbekämpfungsmittel, Salzlösungen, Naphtha und vieles mehr. Durch seine Konstruktion ist er hoch flexibel, robust, öl-, fett-, und chemikalienbeständig

hose construction:

Hose with smooth NBR internal layer and NBR cover, with synthetic twine inlet

range of application:

Multipurpose hose for machine building industry, agriculture and forestry, garages, pits, building sector as well as shipping and railway. It is used among other things in the chemistry and petrochemistry industry, at compressors, drum pumps or in the mineral oil industry. It is resistant to benzene, mineral oil, kerosene, gas oil, fuel- and lube oil, compressed air, cold and hot water, also with cleaner, vegetable oils, animalistic fats, alcohol, biocides, saline solutions, naphtha and many more. Through its construction the Unitrix 80 is high flexible, robust, oil-, fat- and chemical resistant.

Temperaturbereich: -25°C bis +85°C

temperature range: -25°C to +85°C

Innen-Ø internal-Ø mm	Außen-Ø external-Ø mm	Biegeradius bend radius mm	Betriebsdruck working pressure bar	Berstdruck burst pressure bar	Art.-Nr.
6,0	14,0	35	33	80	605 506
8,0	16,0	50	33	80	605 508
10,0	18,0	60	33	80	605 510
13,0	22,0	80	33	80	605 513
16,0	26,0	100	33	80	605 516
19,0	31,0	120	33	80	605 519
25,0	37,0	150	33	80	605 525
32,0	44,0	150	33	80	605 532
38,0	51,0	190	33	80	605 538
50,0	64,0	250	33	80	605 550
60,0	76,0	400	33	80	605 560
75,0	93,0	500	33	80	605 575





Schlauchkonstruktion:

Schlauch mit homogener NBR-Innenschicht und NBR-Außenschicht, mit synthetischen Garneinlagen

Anwendungsbereich:

Universeller Schlauch für Nahrungsmittelbetriebe aller Art. Neben Molkereien, Käsereien, Margarinefabriken, Großküchen, Fischwaren- und Fischkonservenfabriken sowie in Brauereien und Schlachthöfen kann er auch in Ölmühlen, Abdeckereien, Großfleischereien und Marmeladenfabriken zum Einsatz kommen. Der Schlauch ist geeignet zum Durchleiten von Milch, Molke und Heißwasser mit Temperaturen bis 90°C. Durch seine Konstruktion ist er abriebfest, robust, öl-, fett-, und UV-beständig. Er entspricht der FDA.

hose construction:

Hose with homogeneous NBR internal layer and NBR cover, with synthetic twine inlet

range of application:

Universal hose for all kind of food companies. Among creameries, cheese dairies, margarine producers, canteen kitchens, fish-products- and fish-tin companies as well as breweries and butcheries it can also be used in oil mills, flaying houses, huge butcher shops and marmelade factories. The hose can be used to transport milk, whey and hot water with temperatures up to 90°C. Through its construction the TRIX-MULTI-FOOD is abrasion resistant, robust, oil-, fat- and UV-resistant. It is manufactured according to the FDA.

Temperaturbereich: -20°C bis +90°C, dämpfbar bis 6 bar zum Sterilisieren bei +164°C
temperature range: -20°C to +90°C, can be steamed up to +164°C for sterilisation at 6 bar

weiß/white

Innen-Ø internal-Ø mm	Außen-Ø external-Ø mm	Biegeradius bend radius mm	Betriebsdruck working pressure bar	Berstdruck burst pressure bar	Art.-Nr.
13,0	23,0	95	10	60	605 613
16,0	26,0	115	10	60	605 616
19,0	31,0	150	10	60	605 619
25,0	39,0	200	10	60	605 625

blau/blue

Innen-Ø internal-Ø mm	Außen-Ø external-Ø mm	Biegeradius bend radius mm	Betriebsdruck working pressure bar	Berstdruck burst pressure bar	Art.-Nr.
13,0	23,0	95	10	60	605 663
16,0	26,0	115	10	60	605 666
19,0	31,0	150	10	60	605 669
25,0	39,0	200	10	60	605 675

Niederdruckarmaturen

Low pressure fittings

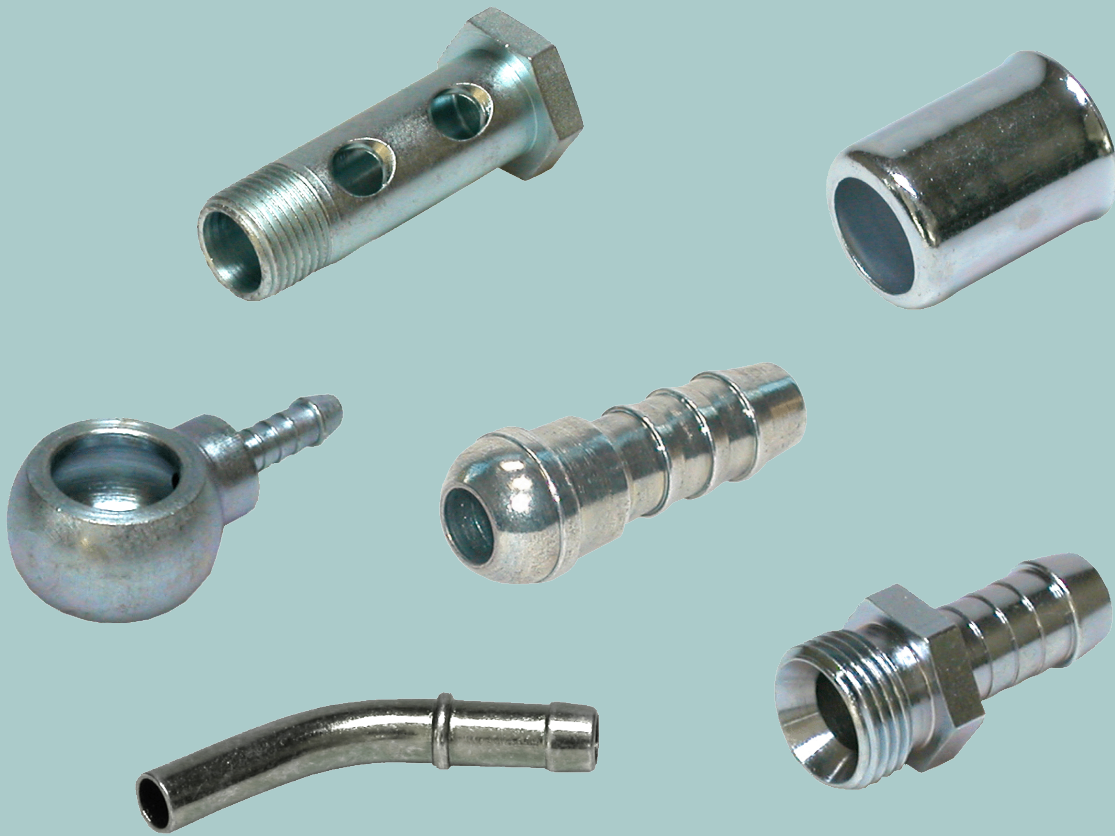

Schlauchhülsen und Nippel

sleeves and nipples

Hohlschrauben

hollow screws

Ringstücke

ring nipple

Lötstücke

solder connections

Doppelstutzen

double connectors

Verschlusschrauben

closure screws

Kugelhähne

ball cocks

Schutzkappen und Stopfen

protector caps and plugs

Schlauchverbinder

hose connectors

Werkzeuge

tools

einbaufertige Schlauchleitungen

hose lines ready for installation

Schlauchhülsen hose sleeves



zum Verpressen von Niederdruckschläuchen
for pressing of low pressure hoses

Werkstoff: Stahl
Oberflächenschutz: verzinkt

material: steel
surface protection: galvanized

Nennweite nominal size	Innen-Ø internal-Ø mm	Bodenloch soil hole Ø/mm (d2)	Gesamtlänge overall length mm (l)	Bezeichnung description	Art.-Nr.
2	9	6,2	17	H 9	204 009
2	10,5	6,2	15	H 10	204 010
4	11,5	7,3	15	H 11,5	204 011
4	12,5	7,3	18	H 12,5	204 012
6	13,5	9,3	20	H 13,5	204 013
6	14,5	9,3	20	H 14,5	204 014
8	15,5	11,3	20	H 15,5	204 015
8	16	11,3	20	H 16	204 016
8	17	11,3	21	H 17	204 017
10	18	13,4	21	H 18	204 018
10	19	13,4	20	H 19	204 019
10	20	14,5	20	H 20	204 020
12	22	16,9	32	H 22	204 022
12	23	16,9	32	H 23	204 023
12	24,5	16,9	32	H 24,5	204 024
12	25,5	16,9	32	H 25	204 025
12	26,5	16,9	32	H 26	204 026
16	28	19,5	32	H 28	204 028
16	30,5	23,7	32	H 30	204 030
20	32	23,8	33	H 32	204 032
20	33	23,8	33	H 33	204 033
20	34,5	23,8	35	H 34,5	204 034
25	36	25	35	H 36	204 036
25	38	27	38	H 38	204 038
25	40	28	40	H 40	204 040

Schlauchnippel mit Dichtkopf hose nipples with conical nipple

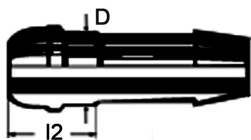

Kugelbuchse für 24° und 60° Aussenkung ähnlich DIN 3868
ballsocket for 24° and 60° inner recess similar to DIN 3868

Werkstoff: Stahl
Oberflächenschutz: verzinkt

material: steel
surface protection: galvanized

Nennweite nominal size	für Schlauch Innen-Ø for hose internal-Ø mm	passend für ÜWM for union nut	l2 mm	D mm	Bezeichnung description	Art.-Nr.
2	4,5	M 10X1 / R 1/8"	13	6,5	N 2	203 602
4	5,5	M 12X1,5 / R 1/4"	14	7,5	N 4	203 604
6	7,5	M 14X1,5 / R 1/4"	13	9,5	N 6	203 606
8	9	M 16X1,5 / R 3/8"	13	11,5	N 8	203 608
10	11	M 18X1,5 / R 1/2"	13	13,5	N 10	203 610
12	14	M 22X1,5 / R 5/8"	13	17	N 13	203 613
12	14	R 1/2"	13	15,5	N 13 / 1/2"	203 612
16	17	M 26X1,5 / M 27X2 / R 3/4"	13	20	N16	203 616
20	21,5	M 30X1,5 / M 30X2 / R 1"	15	24	N 20	203 620
25	25	M 38X1,5	20	31	N 25	203 625

Schlauchnippel mit Dichtkopf hose nipples with conical nipple

Kugelbuchse für 24° und 60° Aussenkung ähnlich DIN 3868 reduziert
ballsocket for 24° and 60° inner recess similar to DIN 3868 reduced

Werkstoff: Stahl

material: steel

Oberflächenschutz: verzinkt

surface protection: galvanized

Nennweite nominal size	für Schlauch Innen-Ø for hose internal-Ø mm	passend für ÜWM for union nut	I2 mm	D mm	Bezeichnung description	Art.-Nr.
4:2	4,5	M 12X1,5 / R 1/4"	13	7,5	N 4:2	203 650
6:4	5,5	M 14X1,5 / R 1/4"	13	9,5	N 6:4	203 652
8:4	5,5	M 16X1,5 / R 3/8"	13	11,5	N 8:4	203 653
8:6	7,5	M 16X1,5 / R 3/8"	13	11,5	N 8:6	203 654
10:8	9	M 18X1,5 / R 1/2"	13	13,5	N 10:8	203 656
12:10	11	M 22X1,5 / R 5/8"	13	17	N 13:10	203 657

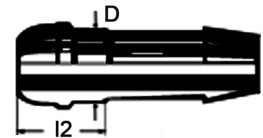

Bundnippel flachdichtend flat flanged nipples

Werkstoff: Stahl

material: steel

Oberflächenschutz: verzinkt

surface protection: galvanized

Nennweite nominal size	für Schlauch Innen-Ø for hose internal-Ø mm	passend für ÜWM for union nut	d2 mm	I2 mm	D mm	Bezeichnung description	Art.-Nr.
2	4,5	M 10X1 / R 1/8"	8,4	7,5	6,5	N 2 fld.	203 702
4	5,5	M 12X1,5 / R 1/4"	9,8	9	7,5	N 4 fld.	203 704
6	7,5	M 14X1,5 / R 1/4"	11	9	9,5	N 6 fld.	203 706
8	9	M 16X1,5 / R 3/8"	13,8	9	11,5	N 8 fld.	203 708
10	11	M 18X1,5 / R 1/2"	15,8	9	13,5	N 10 fld.	203 710
12	14	M 22X1,5 / R 5/8"	19,5	9	17	N 13 fld.	203 713
12	14	R 1/2"	19	9	17	N 13 / 1/2" fld.	203 712
16	17	M 26X1,5 / M 27X2 / R 3/4"	23	9	20	N16 fld.	203 716
20	21,5	M 30X1,5 / M 30X2 / R 1"	27	10	24	N 20 fld.	203 720
16:12	14	M 26X1,5 / R 3/4"	24	9,5	20	N 16:13 fld.	203 750

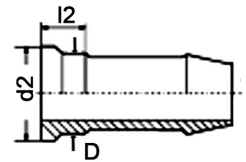

Überwurfmuttern - metrisch union nuts - metrical

DIN 3870 B

Werkstoff: Stahl

material: steel

Oberflächenschutz: verzinkt

surface protection: galvanized

Nennweite nominal size	Gewinde d2 thread d2	Schlüsselweite width across flats	d1 mm	l mm	Bezeichnung description	Art.-Nr.
2	M 10X1	12	6,5	11	U 2	203 802
4	M 12X1,5	14	7,5	14,5	U 4	203 804
6	M 14X1,5	17	9,5	14,5	U 6	203 806
8	M 16X1,5	19	11,5	15,5	U 8	203 808
10	M 18X1,5	22	13,5	15,5	U 10	203 810
12	M 22X1,5	27	17	17	U 13	203 813
16	M 26X1,5	32	20	18	U 16	203 816
16	M 27X2	32	20	18	U 16 / 27X2	203 817
20	M 30X1,5	36	24	17	U 20	203 820
20	M 30X2	36	24	21	U 20 / 30X2	203 821
25	M 38X1,5	46	31,5	19	U 25	203 825

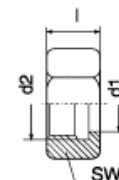

Überwurfmuttern - zöllig

union nuts - inch

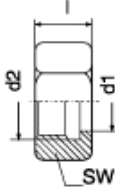

Werkstoff: Stahl
Oberflächenschutz: verzinkt

material: steel
surface protection: galvanized

Nennweite nominal size	Gewinde d2 thread d2	SW	d1 mm	l mm	Bezeichnung description	Art.-Nr.
2	R 1/8"	14	6,5	11	UZ 2	203 902
4	R 1/4"	17	7,5	14	UZ 4	203 904
6	R 1/4"	17	9,5	14	UZ 6	203 906
8	R 3/8"	19	11,5	14	UZ 8	203 908
10	R 1/2"	27	13,5	14	UZ 10	203 910
12	R 1/2"	24	16	16	UZ 13 / 1/2"	203 912
12	R 5/8"	27	17	16	UZ 13	203 913
16	R 3/4"	32	20	16	UZ 16	203 916
20	R 1"	41	24	17	UZ 20	203 920

Rohrbögen 90° mit Dichtkegel - metrisch

elbow 90° with sealing cone - metrical

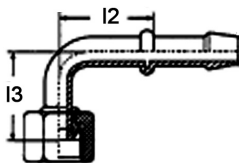

mit 60° Konus
with 60° cone

Werkstoff: Stahl
Oberflächenschutz: verzinkt

material: steel
surface protection: galvanized

Nennweite nominal size	für Schlauch Innen-Ø for hose internal-Ø mm	Gewinde thread	I2 mm	I3 mm	Bezeichnung description	Art.-Nr.
2	4,5	M 10X1	14	24	RBM 2	206 042
4	5,5	M 12X1,5	19	29	RBM 4	206 044
6	7,5	M 14X1,5	26	36	RBM 6	206 046
8	9	M 16X1,5	34	48	RBM 8	206 048
10	11	M 18X1,5	38	49	RBM 10	206 050
12	14	M 22X1,5	50	48	RBM 12	206 053
16	17	M 26X1,5	55	50	RBM 16	206 056
20	21,5	M 30X1,5	55	60	RBM 20	206 060

Rohrbögen 90° mit Dichtkegel - zöllig

elbow 90° with sealing cone - inch

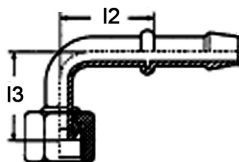

mit 60° Konus
with 60° cone

Werkstoff: Stahl
Oberflächenschutz: verzinkt

material: steel
surface protection: galvanized

Nennweite nominal size	für Schlauch Innen-Ø for hose internal-Ø mm	Gewinde thread	I2 mm	I3 mm	Bezeichnung description	Art.-Nr.
4	5,5	R 1/4"	19	29	RBZ 4	206 064
6	7,5	R 1/4"	26	36	RBZ 6	206 066
8	9	R 3/8"	34	48	RBZ 8	206 068
10	11	R 1/2"	38	49	RBZ 10	206 070
12	14	R 1/2"	50	48	RBZ 12	206 073
16	17	R 3/4"	55	50	RBZ 16	206 076
20	21,5	R 1"	55	60	RBZ 20	206 080

Rohrbögen 90° mit Dichtkegel und Außengewinde - metrisch elbow 90° with sealing cone and external thread - metrical

mit 60° Innen- und Außenkonus
with 60° inner and outer cone

Werkstoff: Stahl

material: steel

Oberflächenschutz: verzinkt

surface protection: galvanized

Nennweite nominal size	Gewinde DKL/CE thread DKL/CE	I2 mm	I3 mm	Bezeichnung description	Art.-Nr.
4	M 12X1,5	38,5	31	RK 4	205 204
6	M 14X1,5	44,5	39,5	RK 6	205 206
8	M 16X1,5	55	49,5	RK 8	205 208
10	M 18X1,5	57,5	50	RK 10	205 210
12	M 22X1,5	63,5	48,5	RK 12	205 213
16	M 26X1,5	46,5	40,5	RK 16	205 216
20	M 30X1,5	53	48	RK 20	205 220
25	M 38X1,5	63	59,5	RK 25	205 225

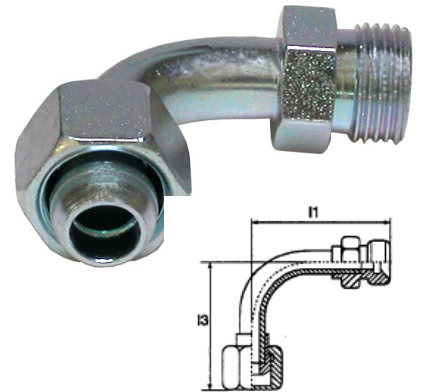

Rohrnippel BE für Schneidringanschluss hose nipples BE for cutting ring connection

Werkstoff: Stahl

material: steel

Oberflächenschutz: verzinkt

surface protection: galvanized

leichte Baureihe
light duty

Nennweite nominal size	für Schlauch Innen-Ø for hose internal-Ø mm	Rohranschluss (d3) pipe connection (d3) mm	I2 mm	Bezeichnung description	Art.-Nr.
1/2	3,5-4,5	4	30	BE 4	203 304
2	4,5	5	25	BE 5	203 305
4	5,5	6	25	BE 6	203 306
6	7,5	8	25	BE 8	203 308
8	9	10	25	BE 10	203 310
10	11	12	25	BE 12	203 312
12	14	15	30	BE 15	203 315
12	14	18	25,5	BE 18:12	203 355
16	17	18	30	BE 18	203 318
20	21,5	22	30	BE 22	203 322
25	25	28	36	BE 28	203 328
25:20	21,5	28	36	BE 28:20	203 329



schwere Baureihe
heavy duty

Nennweite nominal size	für Schlauch Innen-Ø for hose internal-Ø mm	Rohranschluss (d3) pipe connection (d3) mm	I2 mm	Bezeichnung description	Art.-Nr.
4	5,5	8	22,5	BE 8:4	203 350
6	7,5	10	24,5	BE 10:6	203 351
8	9	12	25,5	BE 12:8	203 352
10	11	14	27	BE 14:10	203 353
12	14	16	30	BE 16:12	203 354
16	17	20	32	BE 20:16	203 356
20	21,5	25	34	BE 25:20	203 357
25:20	21,5	30	36	BE 30:20	203 358

Rohrnippel BE 45° für Schneidringanschluss

hose nipples BE 45° for cutting ring connection

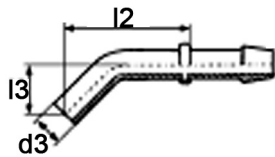

Werkstoff: Stahl
Oberflächenschutz: verzinkt

material: steel
surface protection: galvanized

leichte Baureihe light duty

Nennweite nominal size	für Schlauch Innen-Ø for hose internal-Ø mm	Rohranschluss (d3) pipe connection (d3) mm	l2 mm	l3 mm	Bezeichnung description	Art.-Nr.
2	3,5-4,5	4	30	14	BE 4/45°	206 102
2	4,5	5	30	16	BE 5/45°	206 103
4	5,5	6	30,2	17,1	BE 6/45°	206 104
6	7,5	8	35,7	21,4	BE 8/45°	206 106
8	9	10	42,2	25,8	BE 10/45°	206 108
10	11	12	55	29	BE 12/45°	206 110
12	14	15	70	35	BE 15/45°	206 112
16	17	18	75	34	BE 18/45°	206 116
20	21,5	22	80	46	BE 22/45°	206 120

Rohrnippel BE 90° für Schneidringanschluss

hose nipples BE 90° for cutting ring connection

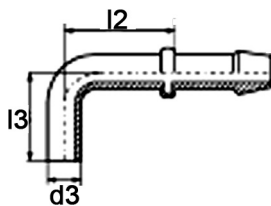

Werkstoff: Stahl
Oberflächenschutz: verzinkt

material: steel
surface protection: galvanized

leichte Baureihe light duty

Nennweite nominal size	für Schlauch Innen-Ø for hose internal-Ø mm	Rohranschluss (d3) pipe connection (d3) mm	l2 mm	l3 mm	Bezeichnung description	Art.-Nr.
2	4,5	4	14	30	BE 4/90°	206 082
2	4,5	5	19	30	BE 5/90°	206 083
4	5,5	6	17	30	BE 6/90°	206 084
6	7,5	8	26	42	BE 8/90°	206 086
8	9	10	34	54	BE 10/90°	206 088
10	11	12	38	55	BE 12/90°	206 090
12	14	15	48	55	BE 15/90°	206 093
16	17	18	55	60	BE 18/90°	206 096
20	21,5	22	60	70	BE 22/90°	206 098

Überwurfmuttern

union nuts

DIN 3870 A

sehr leichte Baureihe

very light duty

Baureihe series	Nenndruck nominal pressure bar	Rohranschluss pipe connection	SW	Gewinde thread	Bezeichnung description	Art.-Nr.
LL	100	4	10	M 8X1	M-LL	432 100
LL	100	5	12	M 10X1	M-LL	432 101
LL	100	6	12	M 10X1	M-LL	432 102
LL	100	8	14	M 12X1	M-LL	432 103
LL	100	10	17	M 14X1	M-LL	432 104
LL	100	12	19	M 16X1	M-LL	432 105
LL	100	16	27	M 22X1,5	M-LL	432 106

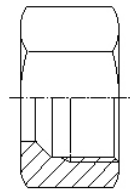

leichte Baureihe

light duty

Baureihe series	Nenndruck nominal pressure bar	Rohranschluss pipe connection	SW	Gewinde thread	Bezeichnung description	Art.-Nr.
L	315	6	14	M 12X1,5	M-L	432 110
L	315	8	17	M 14X1,5	M-L	432 111
L	315	9	17	M 14X1,5	M-L	432 161
L	315	10	19	M 16X1,5	M-L	432 112
L	315	11	19	M 16X1,5	M-L	432 162
L	315	12	22	M 18X1,5	M-L	432 113
L	315	15	27	M 22X1,5	M-L	432 114
L	315	18	32	M 26X1,5	M-L	432 115
L	160	22	36	M 30X2	M-L	432 116
L	160	28	41	M 36X2	M-L	432 117

schwere Baureihe

heavy duty

Baureihe series	Nenndruck nominal pressure bar	Rohranschluss pipe connection	SW	Gewinde thread	Bezeichnung description	Art.-Nr.
S	630	6	17	M 14X1,5	M-S	432 120
S	630	8	19	M 16X1,5	M-S	432 121
S	630	10	22	M 18X1,5	M-S	432 122
S	630	12	24	M 20X1,5	M-S	432 123
S	630	14	27	M 22X1,5	M-S	432 124
S	400	16	30	M 24X1,5	M-S	432 125
S	400	20	36	M 30X2	M-S	432 126
S	400	25	46	M 36X2	M-S	432 127
S	400	30	50	M 42X2	M-S	432 128

Schneidringe cutting rings



sehr leichte Baureihe very light duty

Baureihe series	Nenndruck nominal pressure bar	Rohranschluss pipe connection	Bezeichnung description	Art.-Nr.
LL	100	4	SR-LL	432 200
LL	100	5	SR-LL	432 201
LL	100	6	SR-LL	432 202
LL	100	8	SR-LL	432 203
LL	100	10	SR-LL	432 204
LL	100	12	SR-LL	432 205
LL	100	16	SR-LL	432 206

leichte Baureihe light duty

Baureihe series	Nenndruck nominal pressure bar	Rohranschluss pipe connection	Bezeichnung description	Art.-Nr.
L	315	6	SR-L/S	432 210
L	315	8	SR-L/S	432 211
L	315	9	SR-L	432 261
L	315	10	SR-L/S	432 212
L	315	11	SR-L	432 262
L	315	12	SR-L/S	432 213
L	315	15	SR-L	432 214
L	315	18	SR-L	432 215
L	160	22	SR-L	432 216
L	160	28	SR-L	432 217

schwere Baureihe heavy duty

Baureihe series	Nenndruck nominal pressure bar	Rohranschluss pipe connection	Bezeichnung description	Art.-Nr.
S	630	14	SR-S	432 224
S	400	16	SR-S	432 225
S	400	20	SR-S	432 226
S	400	25	SR-S	432 227
S	400	30	SR-S	432 228

Außengewinde Schlauchnippel - metrisch 24°

external thread hose nipples - metrical 24°

Anschlussart: Stutzen mit 24° Aussenkung passend für Rohrverschraubungen DIN 2353 und DKL/DKOL bzw. DKS/DKOS

Kind of connection: connecting piece with 24° inner recess suitable for pipe connectors DIN 2353 and DKL/DKOL or rather DKS/DKOS

DIN 3870 A

Werkstoff: Stahl

material: steel

Oberflächenschutz: verzinkt

surface protection: galvanized



leichte Baureihe

light duty

NW NS	für Schlauch Innen-Ø for hose internal-Ø mm	Rohransch. (d3) pipe conn. (d3) mm	Gewinde thread d2	I2 mm	I1 mm	SW	Bezeichnung description	Art.-Nr.
1/2	3-4	LL 04	M 8X1	13	8	9	CELL 4	203 204
2	4,5	LL 05	M 10X1	12	8	11	CELL 5	203 205
4	5,5	L 06	M 12X1,5	15	10	12	CEL 6	203 207
6	7,5	L 08	M 14X1,5	16	10	14	CEL 8	203 208
8	9	L 10	M 16X1,5	16	11	17	CEL 10	203 210
10	11	L 12	M 18X1,5	17	11	19	CEL 12	203 212
12	14	L 15	M 22X1,5	18	12	22	CEL 15	203 215
12	14	LL 16	M 22X1,5	18	12	22	CELL 16	203 217
16	17	L 18	M 26X1,5	19	12	27	CEL 18	203 218
20	21,5	L 22	M 30X2	21	14	32	CEL 22	203 222

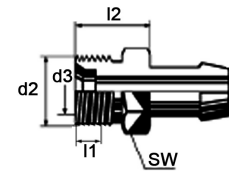

Außengewinde Schlauchnippel - zöllig 60°

external thread nipples - inch 60°

mit 60° Aussenkung
with 60° recess

Werkstoff: Stahl

material: steel

Oberflächenschutz: verzinkt

surface protection: galvanized



NW NS	für Schlauch Innen-Ø for hose internal-Ø mm	Gewinde thread d2	I2 mm	I1 mm	Schlüsselweite width across flats	Bezeichnung description	Art.-Nr.
4	5,5	G 1/8"	17	11	13	A 4 1/8"	203 054
6	7,5	G 1/4"	17	11	17	A 6 1/4"	203 056
8	9	G 3/8"	19	12	19	A 8 3/8"	203 058
12	14	G 1/2"	21	14	24	A 12 1/2"	203 062
16	17	G 5/8"	22	14	27	A 16 5/8"	203 066
20	21,5	G 3/4"	24	16	30	A 20 3/4"	203 070
20	21,5	G 1"	32	20	36	A 20 1"	203 071

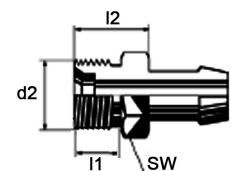

Außengewinde Schlauchnippel - metrisch 60°

external thread hose nipples - metrical 60°

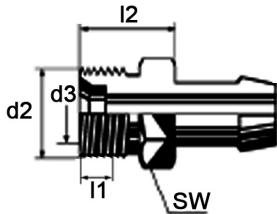

mit 60° Aussenkennung
with 60° recess

Werkstoff: Stahl
Oberflächenschutz: verzinkt

material: steel
surface protection: galvanized

NW NS	für Schlauch Innen-Ø for hose internal-Ø mm	Gewinde thread d2	I2 mm	I1 mm	Schlüsselweite width across flats	Bezeichnung description	Art.-Nr.
2	4,5	M 10X1	12	8	11	A 2	203 002
4	5,5	M 12X1,5	14	10	12	A 4	203 004
6	7,5	M 14X1,5	15	10	14	A 6	203 006
8	9	M 16X1,5	16	11	17	A 8	203 008
10	11	M 18X1,5	16	11	19	A 10	203 010
12	14	M 22X1,5	18	12	22	A 12	203 012
16	17	M 26X1,5	22	12	27	A 16	203 016
20	21,5	M 30X1,5	24	14	30	A 20	203 020

Schlauchnippel mit Einschraubzapfen - metrisch

hose nipples with external thread - metrical

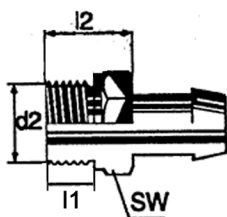

Einschraubzapfen DIN 3852 Form A
external thread DIN 3852 form A

Werkstoff: Stahl
Oberflächenschutz: verzinkt

material: steel
surface protection: galvanized

NW NS	für Schlauch Innen-Ø for hose internal-Ø mm	Gewinde thread d2	I1 mm	I2 mm	Schlüsselweite width across flats	Bezeichnung description	Art.-Nr.
2	4,5	M 10X1	8	14	14	A 2 fld.	203 102
4	5,5	M 12X1,5	12	20	17	A 4 fld.	203 104
6	7,5	M 12X1,5	12	20	17	A 6 fld./12X1,5	203 150
6	7,5	M 14X1,5	12	22	19	A 6 fld.	203 106
8	9	M 16X1,5	12	22	22	A 8 fld.	203 108
10	11	M 18X1,5	12	22	24	A 10 fld.	203 110
12	14	M 22X1,5	12	22	27	A 13 fld.	203 113
12	14	M 26X1,5	12	22	32	A 13 fld./26X1,5	203 152

Schlauchnippel mit Einschraubzapfen - zöllig

hose nipples with external thread - inch

Einschraubzapfen DIN 3852 Form A
external thread DIN 3852 form A

Werkstoff: Stahl
Oberflächenschutz: verzinkt

material: steel
surface protection: galvanized

NW NS	für Schlauch Innen-Ø for hose internal-Ø mm	Gewinde thread d2	I1 mm	I2 mm	SW mm	Bezeichnung description	Art.-Nr.
2	4,5	G 1/8"	8	14	14	A 2 1/8" fld.	203 153
4	5,5	G 1/8"	8	14	14	A 4 1/8" fld.	203 154
4	5,5	G 1/4"	12	19	19	A 4 1/4" fld.	203 155
6	7,5	G 1/4"	12	19	19	A 6 1/4" fld.	203 156
8	9	G 1/4"	12	19	22	A 8 1/4" fld.	203 158
8	9	G 3/8"	12	19	22	A 8 3/8" fld.	203 159
10	11	G 3/8"	12	19	22	A 10 3/8" fld.	203 161
10	11	G 1/2"	14	24	27	A 10 1/2" fld.	203 162
12	14	G 1/2"	14	24	27	A 13 1/2" fld.	203 163
16	17	G 3/4"	16	27	32	A 16 3/4" fld.	203 166
20	21,5	G 3/4"	16	27	32	A 20 3/4" fld.	203 170

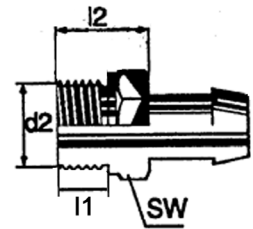

Schlauchnippel mit Einschraubzapfen - zöllig NPT

hose nipples with external thread - inch NPT

Einschraubgewinde: NPT
external thread: NPT

Werkstoff: Stahl
Oberflächenschutz: verzinkt

material: steel
surface protection: galvanized

NW NS	für Schlauch Innen-Ø for hose internal-Ø mm	Einschraubgewinde screw-in thread d2	I1 mm	I2 mm	SW mm	Bezeichnung description	Art.-Nr.
4	5,5	1/8"-27 NPT	10	17	13	A 4 1/8"NPT	203 184
6	7,5	1/4"-18 NPT	14	21	17	A 6 1/4"NPT	203 186
8	9	3/8"-18 NPT	14	21	19	A 8 3/8"NPT	203 188
10	11	3/8"-18 NPT	14	21	19	A 10 3/8"NPT	203 190
12	14	1/2"-14 NPT	19	27	24	A 12 1/2"NPT	203 192
16	17	3/4"-14 NPT	19	29	30	A 16 3/4"NPT	203 196
20	21,5	3/4"-14 NPT	19	29	30	A 20 3/4"NPT	203 200
20	21,5	1"-11,5 NPT	24	36	36	A 20 1"NPT	203 201



Ringnippel ring nipples

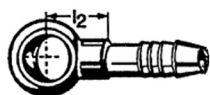

ähnlich DIN 7642
similarly DIN 7642

Werkstoff: Stahl
Oberflächenschutz: verzinkt

material: steel
surface protection: galvanized

NW NS	für Schlauch Innen-Ø for hose internal-Ø mm	Ringauge-Ø ring nipple-Ø mm	l2 mm	Bezeichnung description	Art.-Nr.
2	4,5	8	12	R 2	203 402
4	5,5	10	13	R 4	203 404
6	7,5	12	14	R 6	203 406
8	9	14	16	R 8	203 408
10	11	16	18	R 10	203 410
12	14	18	21	R 13	203 413
16	17	22	27	R 16	203 416
20	21,5	26	32	R 20	203 420

Ringnippel reduziert ring nipples reduced

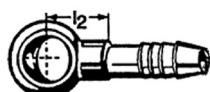

ähnlich DIN 7642
similarly DIN 7642

Werkstoff: Stahl
Oberflächenschutz: verzinkt

material: steel
surface protection: galvanized

NW NS	für Schlauch Innen-Ø for hose internal-Ø mm	Ringauge-Ø ring nipple-Ø mm	l2 mm	Bezeichnung description	Art.-Nr.
4:2	4,5	10	13	R 4:2	203 450
4:6	7,5	10	13	R 4:6	203 470
6:2	4,5	12	14	R 6:2	203 451
6:4	5,5	12	14	R 6:4	203 453
6:8	9	12	14	R 6:8	203 472
8:2	4,5	14	16	R 8:2	203 452
8:4	5,5	14	16	R 8:4	203 454
8:6	7,5	14	16	R 8:6	203 455
10:8	9	16	18	R 10:8	203 456
12:8	9	18	21	R 12:8	203 457
12:10	11	18	21	R 12:10	203 458

Doppelringnippel double ring nipples

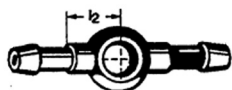

Werkstoff: Stahl
Oberflächenschutz: verzinkt

material: steel
surface protection: galvanized

NW NS	für Schlauch Innen-Ø for hose internal-Ø mm	Ringauge-Ø ring nipple-Ø mm	l2 mm	Bezeichnung description	Art.-Nr.
2	4,5	8	12,3	R 2/2	203 502
4	5,5	10	13	R 4/2	203 504
6	7,5	12	14	R 6/2	203 506
8	9	14	15	R 8/2	203 508
10	11	16	22	R 10/2	203 510

Rohrbögen 90° mit Ringstück flach

elbows 90° with banjo flat

Werkstoff: Stahl

material: steel

Oberflächenschutz: verzinkt

surface protection: galvanized

NW NS	für Schlauch Innen-Ø for hose internal-Ø mm	Ringauge-Ø ring nipple-Ø mm	I2 mm	I3 mm	Bezeichnung description	Art.-Nr.
2	4,5	8	14	27	R 2 B-flach	206 002
4	5,5	10	19	34	R 4 B-flach	206 004
6	7,5	12	26	42	R 6 B-flach	206 006
8	9	14	34	56	R 8 B-flach	206 008
10	11	16	38	61	R 10 B-flach	206 010
12	14	18	50	68	R 13 B-flach	206 013

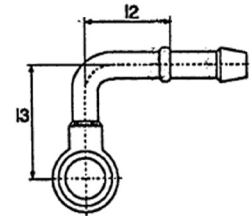

Rohrbögen 90° mit Ringstück hoch

elbows 90° with banjo high

Werkstoff: Stahl

material: steel

Oberflächenschutz: verzinkt

surface protection: galvanized

NW NS	für Schlauch Innen-Ø for hose internal-Ø mm	Ringauge-Ø ring nipple-Ø mm	I2 mm	I3 mm	Bezeichnung description	Art.-Nr.
2	4,5	8	14	27	R 2 B-hoch	206 022
4	5,5	10	19	34	R 4 B-hoch	206 024
6	7,5	12	26	42	R 6 B-hoch	206 026
8	9	14	34	56	R 8 B-hoch	206 028
10	11	16	38	61	R 10 B-hoch	206 030
12	14	18	50	68	R 13 B-hoch	206 033
16	17	22	55	68	R 16 B-hoch	206 036
20	21,5	26	60	78	R 20 B-hoch	206 040

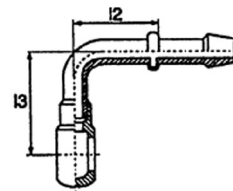

Ringschraubstutzen - metrisch

banjos with thread - metrical

DIN 7641 mit 60° Aussenkung

DIN 7641 with 60° recess

Werkstoff: Stahl

material: steel

Oberflächenschutz: verzinkt

surface protection: galvanized

Ringauge-Ø ring nipple-Ø mm	Gewinde thread d2	I1 mm	Schlüsselweite width across flats	Bezeichnung description	Art.-Nr.
10	M 12X1,5	24	13	RS 10/12	204 202
12	M 14X1,5	27	14	RS 12/14	204 203
14	M 14X1,5	28	14	RS 14/14	204 205
14	M 16X1,5	29	17	RS 14/16	204 206
16	M 18X1,5	31	19	RS 16/18	204 208
18	M 22X1,5	33	22	RS 18/22	204 209

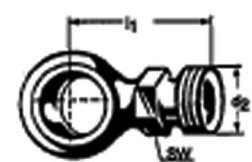

Ringschraubstutzen - zöllig

banjos with thread - inch

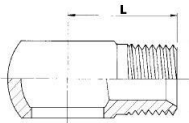

mit 60° Aussenkung
with 60° recess

Werkstoff: Stahl
Oberflächenschutz: verzinkt

material: steel
surface protection: galvanized

Ringauge-Ø ring nipple-Ø mm	Gewinde thread d2	L mm	Bezeichnung description	Art.-Nr.
1/4"	G 1/4"	24	RS 1/4"/1/4"	204 222
3/8"	G 1/4"	27	RS 3/8"/1/4"	204 223
3/8"	G 3/8"	27	RS 3/8"/3/8"	204 226
1/2"	G 3/8"	32	RS 1/2"/3/8"	204 228
1/2"	G 1/2"	32	RS 1/2"/1/2"	204 229
5/8"	G 5/8"	35	RS 5/8"/5/8"	204 230
3/4"	G 1/2"	38	RS 3/4"/1/2"	204 231
3/4"	G 3/4"	38	RS 3/4"/3/4"	204 232
1"	G R1"	46	RS 1"/1"	204 233

Ringschraubstutzen - metrisch

banjos with thread - metrical



mit 24° Aussenkung
with 24° recess

Werkstoff: Stahl
Oberflächenschutz: verzinkt

material: steel
surface protection: galvanized

Im Lieferumfang sind Mutter und Schneidring enthalten.
Delivery contains nut and cutting ring.

Ringauge-Ø ring nipple-Ø mm	Gewinde thread d2	Rohranschluss pipe connection	Bezeichnung description	Art.-Nr.
10	M 12X1,5	L06	RS 10/L06	204 256
10	M 12X1,5	L06	RS 10/L06 mit Sechskant	204 256 01
12	M 12X1,5	L06	RS 12/L06	204 257
12	M 14X1,5	L08	RS 12/L08	204 258
14	M 14X1,5	L08	RS 14/L08	204 259
14	M 16X1,5	L10	RS 14/L10	204 262
14	M 16X1,5	L10	RS 14/L10 mit Sechskant	204 262 01
16	M 18X1,5	L12	RS 16/L12	204 266
16	M 18X1,5	L12	RS 16/L12 mit Sechskant	204 266 01
18	M 22X1,5	L15	RS 18/L22	204 268
22	M 22X1,5	L15	RS 22/L15	204 271
22	M 26X1,5	L18	RS 22/L26	204 272

Ringschraubstutzen - metrisch/zöllig banjos with thread - metrical/inch

mit 24° Aussenkung und zölligem Ringauge
with 24° recess and inch ring hole

Werkstoff: Stahl

material: steel

Oberflächenschutz: verzinkt

surface protection: galvanized

leichte Baureihe light duty

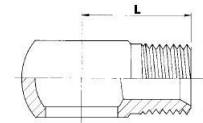

Ringauge-Ø ring nipple-Ø mm	Gewinde thread d2	Rohranschluss pipe connection	L mm	Bezeichnung description	Art.-Nr.
1/4"	M 12x1,5	L06	24	RS 1/4"/L06	204 306
1/4"	M 14x1,5	L08	24	RS 1/4"/L08	204 308
1/4"	M 16x1,5	L10	27	RS 1/4"/L10	204 310
3/8"	M 16x1,5	L10	27	RS 3/8"/L10	204 311
3/8"	M 18x1,5	L12	30	RS 3/8"/L12	204 312
1/2"	M 18x1,5	L12	32	RS 1/2"/L12	204 313
1/2"	M 22x1,5	L15	32	RS 1/2"/L15	204 315

schwere Baureihe heavy duty

Ringauge-Ø ring nipple-Ø mm	Gewinde thread d2	Rohranschluss pipe connection	L mm	Bezeichnung description	Art.-Nr.
1/4"	M 14x1,5	S06	24	RS 1/4"/S06	204 326
1/4"	M 16x1,5	S08	27	RS 1/4"/S08	204 328
3/8"	M 18x1,5	S10	30	RS 3/8"/S10	204 330
1/2"	M 20x1,5	S12	32	RS 1/2"/S12	204 332
1/2"	M 22x1,5	S14	32	RS 1/2"/S14	204 334

Ringschraubstutzen mit Innengewinde banjos with internal thread

Werkstoff: Stahl

material: steel

Oberflächenschutz: verzinkt

surface protection: galvanized

Ringauge-Ø (d2) ring nipple-Ø (d2) mm	Innengewinde internal thread d1	l1 mm	Bezeichnung description	Art.-Nr.
12	M 14x1,5	27	RS 12/14 IG	204 250
14	M 14x1,5	29	RS 14/14 IG	204 251

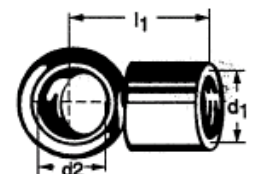

Hohlschrauben - metrisch

hollow screws - metrical

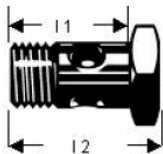

DIN 7643

Werkstoff: Stahl
Oberflächenschutz: verzinkt

material: steel
surface protection: galvanized

metrisch metrical

Nennweite nominal size	Gewinde thread	SW mm	l1 mm	l2 mm	Bezeichnung description	Art.-Nr.
1	M 6X1	11	17	21	HS 1	205 001
2	M 8X1	12	17	22	HS 2	205 002
2	M 8X1,25	12	17	22	HS 2/8X1,25	205 003
4	M 10X1	14	19	25	HS 4	205 004
4	M 10X1,5	14	19	25	HS 4/10X1,5	205 005
6	M 8X1	17	24	29	HS 6/ IG M8X1	205 048
6	M 12X1,5	17	24	30	HS 6	205 006
6	M 12X1,25	17	24	30	HS 6/12X1,25	205 007
8	M 14X1,5	19	26	32	HS 8	205 008
10	M 16X1,5	22	28	34	HS 10	205 010
12	M 18X1,5	24	32	38	HS 13	205 013
16	M 22X1,5	27	39	46	HS 16	205 016
20	M 26X1,5	32	45	52	HS 20	205 020
25	M 30X1,5	36	51	58	HS 25	205 025

zöllig inch

Nennweite nominal size	Gewinde thread	SW mm	l1 mm	l2 mm	Schaft-Ø shaft-Ø mm	Bezeichnung description	Art.-Nr.
4	G 1/8"	14	19	25	10	HS 1/8"	205 160
8	G 1/4"	19	26	32	14	HS 1/4"	205 154
10	G 3/8"	22	28	34	16,6	HS 3/8"	205 159
12	G 1/2"	27	39	46	22	HS 1/2"	205 156

Doppel-Hohlschrauben

double hollow screws

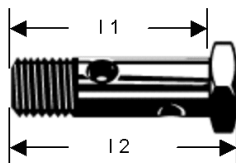

Werkstoff: Stahl
Oberflächenschutz: verzinkt

material: steel
surface protection: galvanized

metrisch metrical

Nennweite nominal size	Gewinde thread	SW mm	l1 mm	l2 mm	Bezeichnung description	Art.-Nr.
2	M 8X1	12	27	32	HS 2/2	205 102
4	M 10X1	14	30	36	HS 4/2	205 104
6	M 12X1,5	17	38	44	HS 6/2	205 106
8	M 14X1,5	19	42	48	HS 8/2	205 108
10	M 16X1,5	22	46	52	HS 10/2	205 110
12	M 18X1,5	24	54	60	HS 13/2	205 113

zöllig inch

Nennweite nominal size	Gewinde thread	SW mm	l1 mm	l2 mm	Schaft-Ø shaft-Ø mm	Bezeichnung description	Art.-Nr.
8	G 1/4"	19	44	50	14	HS 1/4"/2	205 182
10	G 3/8"	22	46	52	16,6	HS 3/8"/2	205 183
12	G 1/2"	27	63	70	22	HS 1/2"/2	205 186

Ringlötstücke solder banjos

DIN 7642

Werkstoff: Stahl

Oberflächenschutz: blank, geölt

material: steel

surface protection: brightly, oiled

Nennweite nominal size	Ringauge-Ø (d2) ring nipple-Ø (d2) mm	Lötanschluss Rohr-Ø soldering conn. pipe-Ø mm (d1)	l1 mm	Bezeichnung description	Art.-Nr.
2,5	8	4	14	RL 2,5	201 202
3	8	5	14	RL 3	201 203
4	10	6	16	RL 4	201 204
6	12	8	18	RL 6	201 206
6	12	6	18	RL 6:6	201 207
8	14	8	20	RL 8:6	201 209
8	14	10	20	RL 8	201 208
10	16	12	22	RL 10	201 210
12	18	15	24	RL 13	201 213
12	18	12	22	RL 13:10	201 214
16	22	18	27	RL 16	201 216
20	26	22	32	RL 20	201 220
25	30	28	37	RL 25	201 225

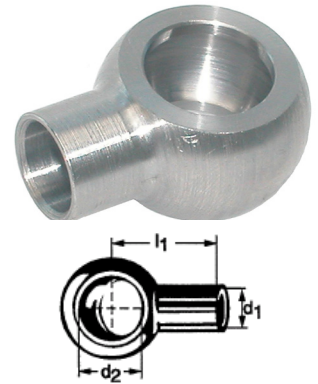

Doppel-Ringlötstücke double solder banjos

Werkstoff: Stahl

Oberflächenschutz: blank, geölt

material: steel

surface protection: brightly, oiled

Nennweite nominal size	Ringauge-Ø (d2) ring nipple-Ø (d2) mm	Lötanschluss Rohr-Ø soldering conn. pipe-Ø mm (d1)	l1 mm	Bezeichnung description	Art.-Nr.
2,5	8	4	14	RL 2,5/2	201 302
3	8	5	14	RL 3/2	201 303
4	10	6	16	RL 4/2	201 304
6	12	8	18	RL 6/2	201 306
8	14	10	20	RL 8/2	201 308
10	16	12	22	RL 10/2	201 310

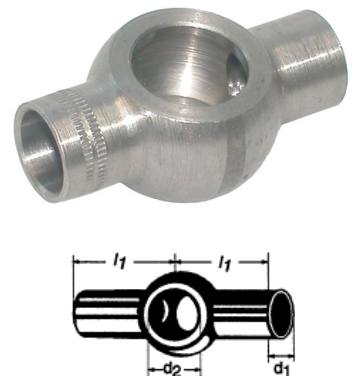

Dichtkegel zum Auflöten sealing cones for soldering

DIN 3863 Form B

Werkstoff: Stahl

Oberflächenschutz: blank, geölt

material: steel

surface protection: brightly, oiled

Nennweite nominal size	passend für ÜWM for union nut	Lötanschluss Rohr-Ø soldering conn. pipe-Ø mm (d4)	l1 mm	t1 mm	Bezeichnung description	Art.-Nr.
4	M 12X1,5 / R 1/4"	6	12	8	LN 4	201 104
6	M 14X1,5 / R 1/4"	8	12	8	LN 6	201 106
8	M 16X1,5 / R 3/8"	10	12	8	LN 8	201 108
10	M 18X1,5 / R 1/2"	12	12	8	LN 10	201 110
12	M 22X1,5	15	14	10	LN 12	201 113
16	M 26X1,5 / R 3/4"	18	14	10	LN 16	201 116
20	M 30X1,5 / M 30X2 / R 1"	22	16	12	LN 20	201 120
25	M 38X1,5	28	18	14	LN 25	201 125

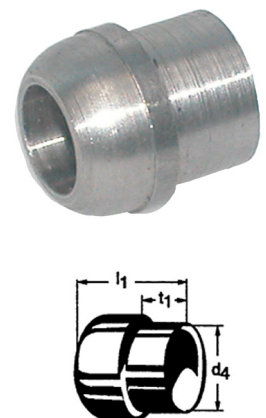

Lötstutzen

soldering connection pieces

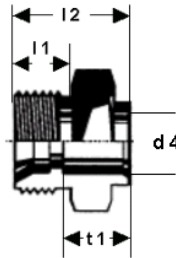

DIN 7633

Werkstoff: Stahl

material: steel

Oberflächenschutz: blank, geölt

surface protection: brightly, oiled

Nennweite nominal size	Gewinde thread	Lötanschluss Rohr-Ø soldering conn. pipe-Ø mm (d4)	SW mm	t1 mm	I1 mm	I2 mm	Bezeichnung description	Art.-Nr.
3	M 10X1	5	11	7,5	8	13	AL 3	201 003
4	M 12X1,5	6	12	7,5	10	15	AL 4	201 004
6	M 14X1,5	8	14	7,5	10	15	AL 6	201 006
8	M 16X1,5	10	17	7,5	11	16	AL 8	201 008
10	M 18X1,5	12	19	7,5	11	16	AL 10	201 010
12	M 22X1,5	15	22	7,5	12	17	AL 13	201 013
16	M 26X1,5	18	27	7,5	12	18	AL 16	201 016
20	M 30X1,5	22	30	10	14	20	AL 20	201 020
25	M 38X1,5	28	41	10	14	20	AL 22	201 025

Doppelstutzen Universal - metrisch

double connectors universal - metrical

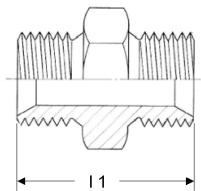

Verbindungsstutzen mit beidseitiger 60° Ausenkung und großem Sechskant mit Dichtfläche Form A zum Einschrauben.

Union connector with both side 60° and large hexagon with sealing surface type A for to srew-in.

Werkstoff: Stahl

material: steel

Oberflächenschutz: verzinkt

surface protection: galvanized

Nennweite nominal size	Gewinde thread	Schlüsselweite width across flats	I1 mm	Bezeichnung description	Art.-Nr.
2	M 10X1	15	25	D 2	202 502
4	M 12X1,5	17	29	D 4	202 504
6	M 14X1,5	19	30	D 6	202 506
8	M 16X1,5	22	34	D 8	202 508
10	M 18X1,5	24	36	D 10	202 510
12	M 20X1,5	27	37	D 10 / M 20X1,5	202 511
12	M 22X1,5	27	36,5	D 13	202 512
16	M 24X1,5	30	40,5	D 16 / M 24X1,5	202 515
16	M 26X1,5	32	42	D 16	202 516
20	M 30X1,5	36	48,5	D 20	202 520
25	M 38X1,5	46	50	D 25	202 525
32	M 45X1,5	50	60	D 32	202 532
40*	M 52X1,5	55	50	D 40	202 540

*NW 40 nur als Verbindungsstutzen lieferbar

*NS 40 only as union connector deliverable

Reduzierstutzen Universal - metrisch

reduction unions universal - metrical

Verbindungsstutzen mit beidseitiger 60° Aussenkung und großem Sechskant mit Dichtfläche Form A zum Einschrauben.

Union connector with both side 60° and large hexagon with sealing surface type A for to screw in.

Werkstoff: Stahl

material: steel

Oberflächenschutz: verzinkt

surface protection: galvanized

Nennweite nominal size	Gewinde thread	Gewinde thread	Schlüsselweite width across flats	l1 mm	Bezeichnung description	Art.-Nr.
4:2	M 12X1,5	M 10X1	17	24,5	UD 4	202 104
6:4	M 14X1,5	M 12X1,5	19	29	UD 6	202 106
8:6	M 16X1,5	M 14X1,5	22	33	UD 8	202 108
10:6	M 18X1,5	M 14X1,5	24	33	UD 10/6	202 111
10:8	M 18X1,5	M 16X1,5	27	36	UD 10	202 110
12:8	M 22X1,5	M 16X1,5	27	37	UD 13/8	202 114
12:10	M 22X1,5	M 18X1,5	27	37	UD 13	202 113
16:12	M 26X1,5	M 22X1,5	32	42	UD 16	202 116

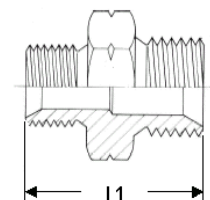

Übergangsstutzen Universal - zöllig auf metrisch

connector unions universal - inch to metrical

Übergangsstutzen von zölligem auf metrisches Gewinde mit beidseitiger 60° Aussenkung zum Verbinden sowie zum Einschrauben mit Dichtfläche Form A.

Connector union inch to metrical thread with both side 60° for connection and screw in with sealing surface type A.

Werkstoff: Stahl

material: steel

Oberflächenschutz: verzinkt

surface protection: galvanized

Gewinde thread	Gewinde thread	Schlüsselweite width across flats	l1 mm	Bezeichnung description	Art.-Nr.
G 1/8"	M 10X1	14	21	UD 2 / G 1/8"	202 611
G 1/4"	M 10X1	19	25,5	UD 2 / G 1/4"	202 621
G 1/4"	M 12X1,5	19	29	UD 4 / G 1/4"	202 622
G 1/4"	M 14X1,5	19	29	UD 6 / G 1/4"	202 623
G 1/4"	M 16X1,5	22	33	UD 8 / G 1/4"	202 624
G 1/4"	M 18X1,5	24	33	UD 10 / G 1/4"	202 625
G 1/4"	M 22X1,5	27	34	UD 13 / G 1/4"	202 626
G 3/8"	M 12X1,5	22	32	UD 4 / G 3/8"	202 632
G 3/8"	M 14X1,5	22	32	UD 6 / G 3/8"	202 633
G 3/8"	M 16X1,5	22	35	UD 8 / G 3/8"	202 634
G 3/8"	M 18X1,5	24	35	UD 10 / G 3/8"	202 635
G 3/8"	M 20X1,5	27	35,5	UD 10-M 20 / G 3/8"	202 636
G 3/8"	M 22X1,5	27	36	UD 13 / G 3/8"	202 637
G 1/2"	M 16X1,5	27	38	UD 8 / G 1/2"	202 644
G 1/2"	M 18X1,5	27	38	UD 10 / G 1/2"	202 645
G 1/2"	M 20X1,5	27	38,5	UD 10-M 20 / G 1/2"	202 646
G 1/2"	M 22X1,5	27	39	UD 13 / G 1/2"	202 647
G 1/2"	M 24X1,5	30	37	UD 13-M 24 / G 1/2"	202 648
G 1/2"	M 26X1,5	30	41	UD 16 / G 1/2"	202 649
G 5/8"	M 18X1,5	27	38	UD 10 / G 5/8"	202 655
G 5/8"	M 22X1,5	27	39	UD 13 / G 5/8"	202 656
G 5/8"	M 26X1,5	30	42	UD 16 / G 5/8"	202 657
G 3/4"	M 18X1,5	32	40	UD 10 / G 3/4"	202 665
G 3/4"	M 22X1,5	32	41	UD 13 / G 3/4"	202 666
G 3/4"	M 26X1,5	32	43	UD 16 / G 3/4"	202 667
G 1"	M 18X1,5	41	43	UD 10 / G 1"	202 675
G 1"	M 30X1,5	41	47	UD 20 / G 1"	202 678
G 1"	M 38X1,5	50	51	UD 25 / G 1"	202 679
G 1 1/4"	M 38X1,5	50	52	UD 25 / G 1 1/4"	202 689

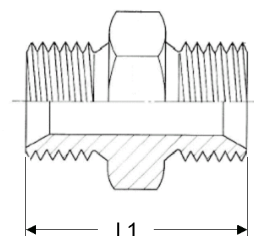

Gewindereduzierungen - metrisch/zöllig

thread reductions - metrical/inch

2

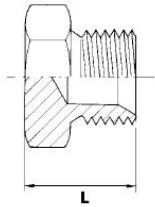

kurze Bauform
short design

Werkstoff: Stahl
Oberflächenschutz: verzinkt

material: steel
surface protection: galvanized

Außengewinde external thread	Innengewinde internal thread	SW mm	L mm	Bezeichnung description	Art.-Nr.
G 1/4"	R 1/8"	19	18	RI 1/4"-1/8"	432 750
G 1/4"	M 10X1	19	18	RI 1/4"-M 10X1	432 751
G 3/8"	R 1/4"	22	21	RI 3/8"-1/4"	432 752
G 1/2"	R 3/8"	27	24	RI 1/2"-3/8"	432 753
G 3/4"	R 1/2"	32	26	RI 3/4"-1/2"	432 754
G 1"	R 3/4"	41	29	RI 1"-3/4"	432 755
G 1 1/4"	R 1"	50	32	RI 1 1/4"-1"	432 756
M 14X1,5	M 10X1	19	18	RI M 14X1,5-M 10X1	432 757
M 16X1,5	M 10X1	22	22	RI M 16X1,5-M 10X1	432 758
M 18X1,5	R 1/4"	24	22	RI M 18X1,5-G 1/4"	432 759
M 22X1,5	R 3/8"	27	19	RST 22-3/8"	300 757
M 22X1,5	R 1/4"	27	19	RST 22-1/4"	300 754

Gewindereduzierungen - metrisch/zöllig

thread reductions - metrical/inch

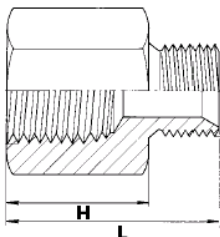

Werkstoff: Stahl
Oberflächenschutz: verzinkt

material: steel
surface protection: galvanized

Außengewinde external thread	Innengewinde internal thread	SW mm	L mm	H mm	Bezeichnung description	Art.-Nr.
G 3/8"	M 16X1,5	22	35	22	RI 3/8"/16X1,5	432 770
G 3/8"	M 18X1,5	24	35	22	RI 3/8"/18X1,5	432 771
G 1/2"	M 18X1,5	27	36	22	RI 1/2"/18X1,5	432 772
G 1/2"	M 22X1,5	27	38	24	RI 1/2"/22X1,5	432 773
G 3/4"	M 18X1,5	32	39	22	RI 3/4"/18X1,5	432 774
M 18X1,5	R 1/4"	24	34	20	RI 18X1,5/1/4"	432 775
M 18X1,5	R 3/8"	24	36	22	RI 18X1,5/3/8"	432 776
M 18X1,5	R 1/2"	27	38	24	RI 18X1,5/1/2"	432 777
M 18X1,5	M 14X1,5	24	34	20	RI 18X1,5/14X1,5	432 778
M 22X1,5	R 1/2"	27	39	24	RI 22X1,5/1/2"	432 779

Verschlusschrauben für Dichtkegel - metrisch

screw plugs for sealing cone - metrical

Verschlusschraube mit metrischem Gewinde und 60° Aussenkung als Blindstopfen für Dichtkegel und Überwurfmutter
screw plug with metrical thread and 60° inner recess as blind connectors for sealing cone and union nut.

Werkstoff: Stahl

material: steel

Oberflächenschutz: verzinkt

surface protection: galvanized

Gewinde thread	Schlüsselweite width across flats	L mm	Bezeichnung description	Art.-Nr.
M 10X1	14	12,5	VS-DKL M 10X1	224 010
M 12X1,5	17	17	VS-DKL M 12X1,5	224 012
M 14X1,5	19	18	VS-DKL M 14X1,5	224 014
M 16X1,5	22	22	VS-DKL M 16X1,5	224 016
M 18X1,5	24	22	VS-DKL M 18X1,5	224 018
M 20X1,5	27	22,5	VS-DKL M 20X1,5	224 020
M 22X1,5	27	23	VS-DKL M 22X1,5	224 022
M 24X1,5	30	23	VS-DKL M 24X1,5	224 024
M 26X1,5	32	27	VS-DKL M 26X1,5	224 026
M 30X1,5	38	29	VS-DKL M 30X1,5	224 030
M 38X1,5	46	32	VS-DKL M 38X1,5	224 038

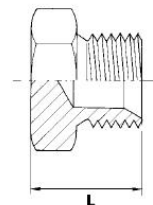

Verschlusschrauben für Dichtkegel - zöllig

screw plugs for sealing cone - inch

Verschlusschraube mit zölligem Gewinde und 60° Aussenkung als Blindstopfen für Dichtkegel und Überwurfmutter
screw plug with inch thread and 60° inner recess as blind connectors for sealing cone and union nut.

Werkstoff: Stahl

material: steel

Oberflächenschutz: verzinkt

surface protection: galvanized

Gewinde thread	Schlüsselweite width across flats	L mm	Bezeichnung description	Art.-Nr.
G 1/8"	14	14,5	VS-DKR G1/8"	49 18 31 00
G 1/4"	19	19	VS-DKR G1/4"	49 18 32 00
G 3/8"	22	20,5	VS-DKR G3/8"	49 18 33 00
G 1/2"	27	24	VS-DKR G1/2"	49 18 34 00
G 5/8"	30	26	VS-DKR G5/8"	49 18 35 00
G 3/4"	32	26,5	VS-DKR G3/4"	49 18 36 00
G 1"	41	30,5	VS-DKR G1"	49 18 37 00
G 1 1/4"	50	39	VS-DKR G1 1/4"	49 18 38 00
G 1 1/2"	55	43	VS-DKR G1 1/2"	49 18 39 00
G 2"	70	48,5	VS-DKR G2"	49 18 40 00

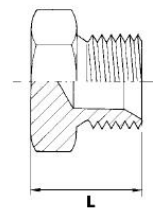

Dichtkegel Verschlusskappen - metrisch

sealing cone screw plugs - metrical

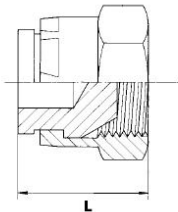

Verschlusskappe mit metrischem Gewinde und 60° Konus als Blindstopfen für Außengewinde CE

Screw plugs with metrical thread and 60° cone as blind connector for external thread CE

Werkstoff: Stahl

material: steel

Oberflächenschutz: verzinkt

surface protection: galvanized

Gewinde thread	Schlüsselweite width across flats	L mm	Bezeichnung description	Art.-Nr.
M 12X1,5	17	17	VM-DKL 12X1,5	224 112
M 14X1,5	19	18	VM-DKL 14X1,5	224 114
M 16X1,5	22	22	VM-DKL 16X1,5	224 116
M 18X1,5	22	22	VM-DKL 18X1,5	224 118
M 20X1,5	27	24	VM-DKL 20X1,5	224 120
M 22X1,5	27	24	VM-DKL 22X1,5	224 122
M 26X1,5	32	28	VM-DKL 26X1,5	224 126

Dichtkegel Verschlusskappen - zöllig

sealing cone screw plug - inch

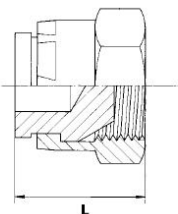

Verschlusskappe mit zölligem Gewinde und 60° Konus als Blindstopfen für Außengewinde

Screw plugs with inch thread and 60° cone as blind connector for external thread

Werkstoff: Stahl

material: steel

Oberflächenschutz: verzinkt

surface protection: galvanized

Gewinde thread	Schlüsselweite width across flats	L mm	Bezeichnung description	Art.-Nr.
R 1/4"	19	20,7	VM-DKR 1/4"	49 19 32 00
R 3/8"	22	24,3	VM-DKR 3/8"	49 19 33 00
R 1/2"	27	26,4	VM-DKR 1/2"	49 19 34 00
R 5/8"	28	28,5	VM-DKR 5/8"	49 19 35 00
R 3/4"	32	30,5	VM-DKR 3/4"	49 19 36 00
R 1"	58	34,5	VM-DKR 1"	49 19 37 00
R 1 1/4"	50	42,5	VM-DKR 1 1/4"	49 19 38 00
R 1 1/2"	55	45	VM-DKR 1 1/2"	49 19 39 00

Mini-Kugelhähne Innengewinde/Außengewinde- zöllig

mini-ball valves internal thread/external thread - inch

mit Innengewinde/Außengewinde
with internal thread/external thread

Gehäuse und Kugel: Messing verchromt

Kugeldichtung: Teflon

Schaltwelle: Messing

Griff: Nylon

Temperaturbereich: -20°C bis +90°C (abhängig vom Betriebsdruck)

temperature range: -20°C to +90°C (dependent on the operating pressure)

housing and ball: brass chromium plated

ball seal: teflon

control shaft: brass

handle: nylon

PN bar	Innen-/Außengewinde internal-/external thread	SW mm	Gesamtlänge overall length mm	Höhe height mm	Bezeichnung description	Art.-Nr.
30	R 1/8" / G 1/8"	21	41,5	39	MKH-IG/AG 1/8"	419 441
30	R 1/4" / G 1/4"	21	41,5	39	MKH-IG/AG 1/4"	419 442
30	R 3/8" / G 3/8"	21	41,5	39	MKH-IG/AG 3/8"	419 443
30	R 1/2" / G 1/2"	25	49	43	MKH-IG/AG 1/2"	419 444
30	R 3/4" / G 3/4"	30	54	47,5	MKH-IG/AG 3/4"	419 446

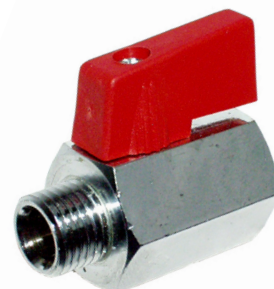

Mini-Kugelhähne Innengewinde- zöllig

mini-ball valves internal thread - inch

mit Innengewinde
with internal thread

Gehäuse und Kugel: Messing verchromt

Kugeldichtung: Teflon

Schaltwelle: Messing

Griff: Nylon

Temperaturbereich: -20°C bis +90°C (abhängig vom Betriebsdruck)

temperature range: -20°C to +90°C (dependent on the operating pressure)

housing and ball: brass chromium plated

ball seal: teflon

control shaft: brass

handle: nylon

PN bar	Innengewinde internal thread	Schlüsselweite width across flats	Gesamtlänge overall length mm	Höhe height mm	Bezeichnung description	Art.-Nr.
30	R 1/8"	21	41,5	39	MKH-IG 1/8"	419 431
30	R 1/4"	21	41,5	39	MKH-IG 1/4"	419 432
30	R 3/8"	21	41,5	39	MKH-IG 3/8"	419 433
30	R 1/2"	25	49	43	MKH-IG 1/2"	419 434
30	R 3/4"	30	54	47,5	MKH-IG 3/4"	419 436



Muffen-Kugelhähne Innengewinde - zöllig

ball cocks internal thread - inch



mit langem Innengewinde ISO 228 und Hahnschlüssel
with long internal thread ISO 228 and cock lever

Gehäuse: Pressmessing matt-verchromt

Kugel: Messing matt-verchromt

Schaltwelle: Messing

Kugeldichtung: PTFE

Temperaturbereich: -20°C bis +170°C (abhängig vom Betriebsdruck)

temperature range: -20°C to +170°C (dependent on the operating pressure)

housing: press brass dull-chromium plated

ball: brass dull-chromium plated

control shaft: brass

ball sealing: PTFE

PN bar	Innengewinde internal thread	Gesamtlänge overall length mm	Bezeichnung description	Art.-Nr.
40	R 1/4"	39	MUKH-IG 1/4"	419 451
40	R 3/8"	39	MUKH-IG 3/8"	419 452
40	R 1/2"	50	MUKH-IG 1/2"	419 453
40	R 3/4"	54	MUKH-IG 3/4"	419 455
40	R 1"	67	MUKH-IG 1"	419 456
40	R 1 1/4"	77	MUKH-IG 1 1/4"	419 457
40	R 1 1/2"	90	MUKH-IG 1 1/2"	419 458
40	R 2"	106	MUKH-IG 2"	419 459
30	R 2 1/2"	136	MUKH-IG 2 1/2"	419 460

Muffen-Kugelhähne Innengewinde/Außengewinde - zöllig

ball cocks internal thread/external thread - inch



mit langem Innengewinde ISO 228/Außengewinde und Hahnschlüssel
with long internal thread ISO 228/external thread and cock lever

Gehäuse: Pressmessing matt-verchromt

Kugel: Messing matt-verchromt

Schaltwelle: Messing

Kugeldichtung: PTFE

Temperaturbereich: -20°C bis +170°C (abhängig vom Betriebsdruck)

temperature range: -20°C to +170°C (dependent on the operating pressure)

housing: press brass dull-chromium plated

ball: brass dull-chromium plated

control shaft: brass

ball sealing: PTFE

PN bar	Innen-/Außengewinde internal-/external thread	Gesamtlänge overall length mm	Bezeichnung description	Art.-Nr.
40	R 1/4" / G 1/4"	47,5	MUKH-IG/AG 1/4"	419 461
40	R 3/8" / G 3/8"	47,5	MUKH-IG/AG 3/8"	419 462
40	R 1/2" / G 1/2"	57,5	MUKH-IG/AG 1/2"	419 463
40	R 3/4" / G 3/4"	63	MUKH-IG/AG 3/4"	419 465
40	R 1" / G 1"	75,5	MUKH-IG/AG 1"	419 466
40	R 1 1/4" / G 1 1/4"	86	MUKH-IG/AG 1 1/4"	419 467
40	R 1 1/2" / G 1 1/2"	97,5	MUKH-IG/AG 1 1/2"	419 468
40	R 2" / G 2"	114,5	MUKH-IG 2"	419 469

Muffen-Kugelhähne Innengewinde - zöllig

ball cocks internal thread - inch

mit Innengewinde und Hahnschlüssel
with internal thread and cock lever

Gehäuse: Pressmessing matt-verchromt

Kugel: Messing matt-verchromt

Schaltwelle: Messing

Kugeldichtung: Teflon

Temperaturbereich: -20°C bis +150°C (abhängig vom Betriebsdruck)

temperature range: -20°C to +150°C (dependent on the operating pressure)

housing: press brass dull-chromium plated

ball: brass dull-chromium plated

control shaft: brass

ball sealing: teflon



PN bar	Innengewinde internal thread	Gesamtlänge overall length mm	Bezeichnung description	Art.-Nr.
64	R 1/4"	40	MUKH-IG 1/4"	419 531
64	R 3/8"	43	MUKH-IG 3/8"	419 532
40	R 1/2"	48	MUKH-IG 1/2"	419 533
40	R 3/4"	58	MUKH-IG 3/4"	419 535
40	R 1"	68	MUKH-IG 1"	419 536
25	R 1 1/4"	81	MUKH-IG 1 1/4"	419 537
25	R 1 1/2"	94	MUKH-IG 1 1/2"	419 538
25	R 2"	112	MUKH-IG 2"	419 539
25	R 2 1/2"	136	MUKH-IG 2 1/2"	419 540

Muffen-Kugelhähne Innengewinde/Außengewinde - zöllig

ball cocks internal thread/external thread - inch

mit Innengewinde/Außengewinde und Hahnschlüssel
with internal thread/external thread and cock lever

Gehäuse: Pressmessing matt-verchromt

Kugel: Messing matt-verchromt

Schaltwelle: Messing

Kugeldichtung: Teflon

Temperaturbereich: -20°C bis +150°C (abhängig vom Betriebsdruck)

temperature range: -20°C to +150°C (dependent on the operating pressure)

housing: press brass dull-chromium plated

ball: brass dull-chromium plated

control shaft: brass

ball sealing: teflon



PN bar	Innen-/Außengewinde internal-/external thread	Gesamtlänge overall length mm	Bezeichnung description	Art.-Nr.
64	R 1/4" / G 1/4"	47,5	MUKH-IG/AG 1/4"	419 541
64	R 3/8" / G 3/8"	49,5	MUKH-IG/AG 3/8"	419 542
40	R 1/2" / G 1/2"	53	MUKH-IG/AG 1/2"	419 543
40	R 3/4" / G 3/4"	63	MUKH-IG/AG 3/4"	419 545
40	R 1" / G 1"	74	MUKH-IG/AG 1"	419 546
25	R 1 1/4" / G 1 1/4"	98	MUKH-IG/AG 1 1/4"	419 547
25	R 1 1/2" / G 1 1/2"	101,5	MUKH-IG/AG 1 1/2"	419 548
25	R 2" / G 2"	121	MUKH-IG/AG 2"	419 549

Muffenschieber - zöllig

sleeve valve - inch



mit Innengewinde und Handrad
with internal thread and handwheel

Werkstoff: Messing, Handrad Guss
material: brass, messing, handwheel cast

PN bar	Innengewinde internal thread	Gesamtlänge overall length mm	Durchgang description mm	Bezeichnung description	Art.-Nr.
16	R 1/2"	42	15	MUKH-IG 1/2"	419 574
16	R 3/4"	46	19	MUKH-IG 3/4"	419 576
16	R 1"	52	24	MUKH-IG 1"	419 577
16	R 1 1/4"	58	30	MUKH-IG 1 1/4"	419 578
16	R 1 1/2"	63,5	37	MUKH-IG 1 1/2"	419 579
16	R 2"	68	47	MUKH-IG 2"	419 580

3-Wege-Kugelhähne Innengewinde mit L-Bohrung - zöllig

3-way-ball cocks internal thread with L bore hole - inch



mit Innengewinde und Hahnschlüssel
with internal thread and cock lever

Gehäuse: Pressmessing matt-verchromt

Kugel: Messing matt-verchromt

Schaltwelle: Messing

Kugeldichtung: PTFE

Temperaturbereich: -20°C bis +150°C (abhängig vom Betriebsdruck)

temperature range: -20°C to +150°C (dependent on the operating pressure)

housing: press brass dull-chromium plated

ball: brass dull-chromium plated

control shaft: brass

ball sealing: PTFE

PN bar	Innengewinde internal thread	Gesamtlänge overall length mm	Bezeichnung description	Art.-Nr.
40	R 1/4"	80,5	MUKH-IG 1/4"	419 511
40	R 3/8"	80,5	MUKH-IG 3/8"	419 512
40	R 1/2"	80,5	MUKH-IG 1/2"	419 513
40	R 3/4"	93,4	MUKH-IG 3/4"	419 515
25	R 1"	107	MUKH-IG 1"	419 516
16	R 1 1/4"	118	MUKH-IG 1 1/4"	419 517
16	R 1 1/2"	141	MUKH-IG 1 1/2"	419 518
16	R 2"	164	MUKH-IG 2"	419 519

Gewindeschutzkappen thread protector caps

für Innengewinde for internal thread

Werkstoff: Polyethylen (LD PE)
material: polyethylene (LD PE)

Gewinde thread	Bezeichnung description	Art.-Nr.
M 6	SK-IG M6	245 106
M 8	SK-IG M8	245 108
M 10	SK-IG M10	245 110
M 12	SK-IG M12	245 112
M 14	SK-IG M14	245 114
M 16	SK-IG M16	245 116
M 18	SK-IG M18	245 118
M 20	SK-IG M20	245 120
M 22	SK-IG M22	245 122
M 24	SK-IG M24	245 124
M 26	SK-IG M26	245 126
M 28	SK-IG M28	245 128
M 30	SK-IG M30	245 130
M 32	SK-IG M32	245 132
M 33	SK-IG M33	245 133
M 36	SK-IG M36	245 136
M 38	SK-IG M38	245 138
M 42	SK-IG M42	245 142
M 45	SK-IG M45	245 145
M 52	SK-IG M52	245 152



Gewindeschutzkappen thread protector caps

für Außengewinde for external thread

Werkstoff: Polyethylen (LD PE)
material: polyethylene (LD PE)

Gewinde thread	Bezeichnung description	Art.-Nr.
M 8	SK-AG M8	245 008
M 10	SK-AG M10	245 010
M 12	SK-AG M12	245 012
M 14	SK-AG M14	245 014
M 16	SK-AG M16	245 016
M 18	SK-AG M18	245 018
M 20	SK-AG M20	245 020
M 22	SK-AG M22	245 022
M 24	SK-AG M24	245 024
M 26	SK-AG M26	245 026
M 28	SK-AG M28	245 028
M 30	SK-AG M30	245 030
M 32	SK-AG M32	245 032
M 33	SK-AG M33	245 033
M 36	SK-AG M36	245 036
M 38	SK-AG M38	245 038
M 42	SK-AG M42	245 042
M 45	SK-AG M45	245 045
M 52	SK-AG M52	245 052



Schraubstopfen - metrisch

threaded caps - metrical



Gewinde-Schutzstopfen für Innengewinde

threaded caps for internal thread

Werkstoff: Polyethylen (HD PE)
material: polyethylene (HD PE)

Gewinde thread	Bezeichnung description	Art.-Nr.
M 10X1	PE-STO M10	245 410
M 12X1,5	PE-STO M12	245 412
M 14X1,5	PE-STO M14	245 414
M 16X1,5	PE-STO M16	245 416
M 18X1,5	PE-STO M18	245 418
M 20X1,5	PE-STO M20	245 420
M 22X1,5	PE-STO M22	245 422
M 24X1,5	PE-STO M24	245 424
M 26X1,5	PE-STO M26	245 426
M 30X2	PE-STO M30	245 430
M 36X2	PE-STO M36	245 436
M 42X2	PE-STO M42	245 442
M 45X2	PE-STO M45	245 445
M 52X2	PE-STO M52	245 452

Schraubkappen - metrisch

threaded caps - metrical



Gewinde-Schutzstopfen für Außengewinde

threaded caps for external thread

Werkstoff: Polyethylen (HD PE)
material: polyethylene (HD PE)

Gewinde thread	Bezeichnung description	Art.-Nr.
M 10X1	PE-KAP M10	245 510
M 12X1,5	PE-KAP M12	245 512
M 14X1,5	PE-KAP M14	245 514
M 16X1,5	PE-KAP M16	245 516
M 18X1,5	PE-KAP M18	245 518
M 20X1,5	PE-KAP M20	245 520
M 22X1,5	PE-KAP M22	245 522
M 24X1,5	PE-KAP M24	245 524
M 26X1,5	PE-KAP M26	245 526
M 30X2	PE-KAP M30	245 530
M 36X2	PE-KAP M36	245 536
M 42X2	PE-KAP M42	245 542
M 45X2	PE-KAP M45	245 545
M 52X2	PE-KAP M52	245 552

Schraubstopfen - zöllig

threaded caps - inch

Gewinde-Schutzstopfen für Innengewinde

threaded caps for internal thread

Werkstoff: Polyethylen (LD PE)
material: polyethylene (LD PE)

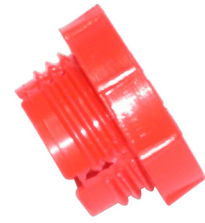

Gewinde thread	Bezeichnung description	Art.-Nr.
G 1/8"	PE-STO G 1/8"	245 461
G 1/4"	PE-STO G 1/4"	245 462
G 3/8"	PE-STO G 3/8"	245 463
G 1/2"	PE-STO G 1/2"	245 464
G 5/8"	PE-STO G 5/8"	245 465
G 3/4"	PE-STO G 3/4"	245 466
G 1"	PE-STO G 1"	245 467
G 1 1/4"	PE-STO G 1 1/4"	245 468
G 1 1/2"	PE-STO G 1 1/2"	245 469
G 2"	PE-STO G 2"	245 470

Schraubkappen - zöllig

threaded caps - inch

Gewinde-Schutzstopfen für Außengewinde

threaded caps for external thread

Werkstoff: Polyethylen (LD PE)
material: polyethylene (LD PE)



Gewinde thread	Bezeichnung description	Art.-Nr.
R 1/8"	PE-KAP R 1/8"	245 561
R 1/4"	PE-KAP R 1/4"	245 562
R 3/8"	PE-KAP R 3/8"	245 563
R 1/2"	PE-KAP R 1/2"	245 564
R 5/8"	PE-KAP R 5/8"	245 565
R 3/4"	PE-KAP R 3/4"	245 566
R 1"	PE-KAP R 1"	245 567
R 1 1/4"	PE-KAP R 1 1/4"	245 568
R 1 1/2"	PE-KAP R 1 1/2"	245 569
R 2"	PE-KAP R 2"	245 570

gerade Schlauchverbinder

straight hose connectors

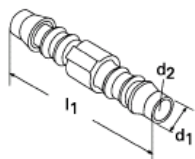

Werkstoff: Acetalcopolymerisat (POM)
material: acetalcopolymerisate (POM)

für Schlauch Innen-Ø for hose internal-Ø mm (d1)	d2 mm	l1 mm	Bezeichnung description	Art.-Nr.
3	2,5	25	GS 3 PL	244 237
4	2,7	35	GS 4 PL	244 301
5	3	45	GS 5 PL	244 302
6	4	49	GS 6 PL	244 303
8	5,6	56	GS 8 PL	244 304
10	7	63	GS 10 PL	244 305
12	8,6	66,5	GS 12 PL	244 306
13	8,6	73	GS 13 PL	244 307
14	10	79	GS 14 PL	244 308
16	12	75	GS 16 PL	244 309
19	15	76	GS 19 PL	244 238
25	21	95	GS 25 PL	244 239

reduzierte gerade Schlauchverbinder

reduced straight hose connectors

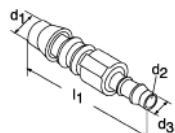

Werkstoff: Acetalcopolymerisat (POM)
material: acetalcopolymerisate (POM)

für Schlauch Innen-Ø for hose internal-Ø mm (d1)	für Schlauch Innen-Ø for hose internal-Ø mm (d3)	d2 mm	l1 mm	Bezeichnung description	Art.-Nr.
4	3	2,5	30	GRS 4-3 PL	244 260
6	4	2,7	43,5	GRS 6-4 PL	244 262
8	4	2,7	48,0	GRS 8-4 PL	244 263
8	6	4,0	53,5	GRS 8-6 PL	244 264
10	6	4,0	58,0	GRS 10-6 PL	244 265
10	8	5,6	60,5	GRS 10-8 PL	244 266
12	8	5,6	62,5	GRS 12-8 PL	244 267
12	10	7,0	64,0	GRS 12-10 PL	244 268

Winkel Schlauchverbinder

angle unions

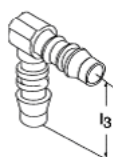

Werkstoff: Acetalcopolymerisat (POM)
material: acetalcopolymerisate (POM)

für Schlauch Innen-Ø for hose internal-Ø mm	l3 mm	Bezeichnung description	Art.-Nr.
3	12,5	WS 3 PL	244 270
4	19,5	WS 4 PL	244 271
5	22	WS 5 PL	244 272
6	26	WS 6 PL	244 273
8	30	WS 8 PL	244 274
10	33,5	WS 10 PL	244 275
12	36	WS 12 PL	244 276
13	38,5	WS 13 PL	244 277
14	41,5	WS 14 PL	244 278
15	43,5	WS 15 PL	244 279
16	45	WS 16 PL	244 231
19	46	WS 19 PL	244 232
25	46	WS 25 PL	244 233

T-Schlauchverbinder

T-unions

Werkstoff: Acetalcopolymerisat (POM)
material: acetalcopolymerisate (POM)

für Schlauch Innen-Ø for hose internal-Ø mm (d1)	I1 mm	I3 mm	d2 mm	Bezeichnung description	Art.-Nr.
3	25	12,5	2,5	T 3 PL	244 280
4	35	19,5	2,7	T 4 PL	244 281
5	42	22	3	T 5 PL	244 282
6	50	26	4	T 6 PL	244 283
7	50	26	5	T 7 PL	244 245
8	58	30	5,6	T 8 PL	244 284
10	62,5	33,5	7	T 10 PL	244 285
12	69	36	8,6	T 12 PL	244 286
13	73	38,5	8,6	T 13 PL	244 246
14	77,5	41,5	10	T 14 PL	244 287
15	79,5	43,5	11	T 15 PL	244 288
16	81	45	12	T 16 PL	244 247
19	85	46	15	T 19 PL	244 248
25	105	52,5	21	T 25 PL	244 249

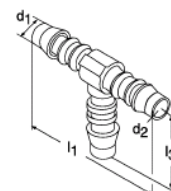

reduzierte T-Schlauchverbinder

reduced T-unions

Werkstoff: Acetalcopolymerisat (POM)
material: acetalcopolymerisate (POM)

für Schlauch Innen-Ø for hose internal-Ø mm (d1)	für Schlauch Innen-Ø for hose internal-Ø mm (d2)	I1 mm	I3 mm	d2 mm	Bezeichnung description	Art.-Nr.
3	4	25	17,5	2,5	TRS 3-4-3 PL	244 225
4	6	35	23,5	2,5	TRS 4-6-4 PL	244 289
6	4	49	20,5	4	TRS 6-4-6 PL	244 290
8	4	56	22	5,6	TRS 8-4-8 PL	244 291
8	6	56	28	5,6	TRS 8-6-8 PL	244 292
8	12	58	35,5	5,6	TRS 8-12-8 PL	244 298
10	6	62	28	7	TRS 10-6-10 PL	244 293
10	8	62	31	7	TRS 10-8-10 PL	244 296
10	13	64	38	7	TRS 10-13-10 PL	244 299
12	6	69	29	8,6	TRS 12-6-12 PL	244 294
12	8	69	31	8,6	TRS 12-8-12 PL	244 297
12	10	69	33	8,6	TRS 12-10-12 PL	244 241
15	6	78	28	11	TRS 15-6-15 PL	244 295
15	8	79	33	11	TRS 15-8-15 PL	244 242
18	10	79	36	14	TRS 18-10-18 PL	244 243
18	15	80	44	14	TRS 18-15-18 PL	244 244

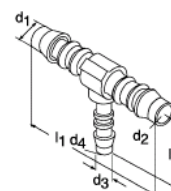

Y-Schlauchverbinder

Y-unions

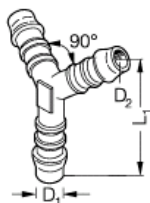

Werkstoff: Acetalcopolymerisat (POM)

material: acetalcopolymerisate (POM)

für Schlauch Innen-Ø for hose internal-Ø mm (d1)	l1 mm	d2 mm	Bezeichnung description	Art.-Nr.
3	21	2,5	YS 3 PL	244 250
4	25,5	2,5	YS 4 PL	244 251
5	43	3	YS 5 PL	244 252
6	44	4	YS 6 PL	244 253
8	51	5,6	YS 8 PL	244 254
10	54	7	YS 10 PL	244 255
12	64	8,6	YS 12 PL	244 256
13	65	9	YS 13 PL	244 236
14	65	10	YS 14 PL	244 257
16	67	12	YS 16 PL	244 258
19	72	15	YS 19 PL	244 259

reduziert/reduced

6	35	4	YS 4-6-4 PL	244 234
8	49	6	YS 6-8-6 PL	244 235

Presswerkzeug „Arnstein“

pressing tool „Arnstein“

von DN 2-13

einfache und schnelle Befestigung im Schraubstock
saubere Verpressung durch 6 Pressbacken und automatische Pressbackenführung
hohe Flexibilität durch mobile Einsatzmöglichkeit
maximale Werkzeugöffnung: 38 mm

to DN 2-13

simple and fast attachment in the vice
clean pressing by 6 dies and automatic die guidance
high flexibility by mobile using possibilities
maximum tool-opening: 38 mm

Lieferumfang: Presswerkzeug, ein Pressbackensatz DN 2- 8 im Werkzeug und ein Pressbackensatz DN 10 - 13 im Handhebel

range of supply: pressing tool, one die set DN 2-8 in the tool and one die DN 10 - 13 in the hand lever

für Schlauch bis NW for hose up to NS	Bezeichnung description	Art.-Nr.
2-13	Presswerkzeug „Arnstein“	209 001



Presswerkzeug „Bielefeld“ pressing tool „Bielefeld“

von DN 2 bis DN 8

einfache und schnelle Befestigung im Schraubstock
saubere Verpressung durch 6 Pressbacken
Verpressung erfolgt durch Zudrehen des Schraubstockes

from DN 2 up to DN 8

simple and fast attachment in the vice
clean pressing by 6 dies
pressing effected through closing the vice

Lieferumfang: Presswerkzeug mit einem Pressbackensatz DN 2-8
range of supply: pressing tool with one die set DN 2-8

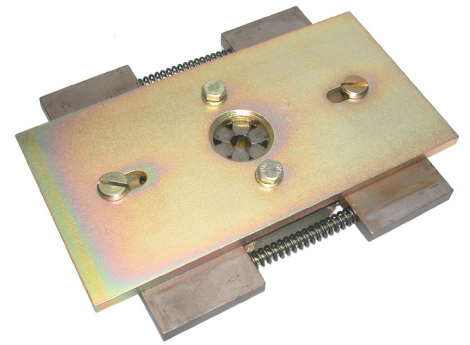

für Schlauch bis NW for hose up to NS	Bezeichnung description	Art.-Nr.
2-8	Presswerkzeug "Bielefeld"	209 002

Ersatzpressbacken Spare dies

Lieferumfang: 1 Satz entspricht 6 Pressbacken
delivery condition: 1 set conforms 6 spare dies

für Presswerkzeug for pressing tool	NW NS	Art.-Nr.
"Arnstein"	2-8	209 022
"Arnstein"	10-13	209 023
"Bielefeld"	2-8	209 021

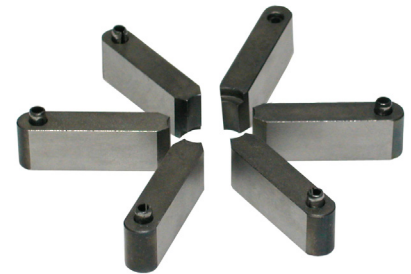

Montagevorrichtung assembly tool

zur Vormontage von Niederdruckleitungen

zwei Dorne zum Aufweiten des Schlauches
fünf Zapfen zur Aufnahme der zu montierenden Ringnippel

for pre-assembly of low pressure lines

two mandrels in order to expand the hose
five pins for the adjustment of the ring nipple which have to be fitted

für Schlauch bis NW for hose up to NS	Bezeichnung description	Art.-Nr.
2-13	Montagegerät	209 004

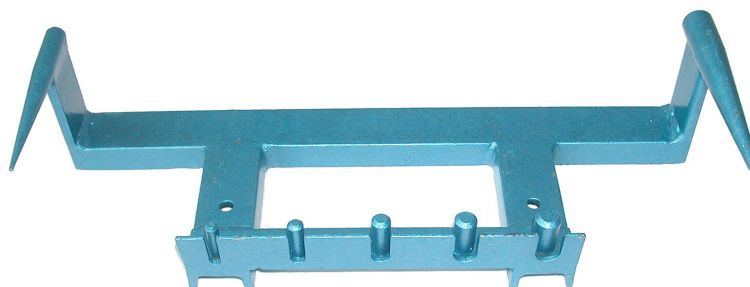

Notizen/notes

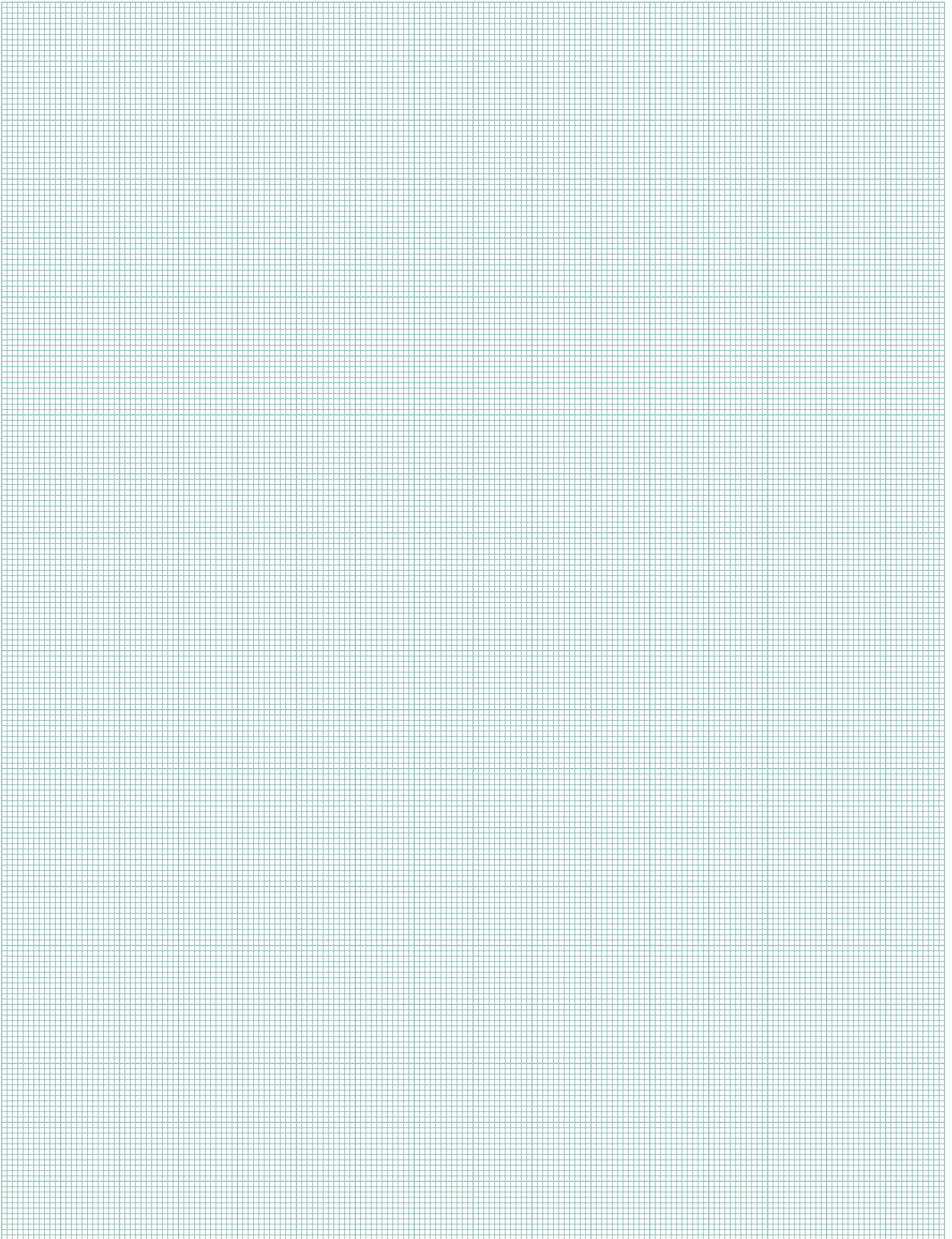

Polyamidrohr und Armaturen

Polyamide pipes and armatures



Polyamidrohr

polyamide pipe

Werkzeuge

tools

Schlauchnippel

hose nipple

Ringstücke

ring pieces

Rohnippel

pipe nipples

Verbinder

connectors

Verstärkungshülsen

reinforcement sleeves

Verschraubungen

screw connections

Steckverbinder

plug connectors

Polyamidrohr

polyamide pipe



* Polyamidrohr wird auf Spule geliefert
Polyamide tube is delivered on a paper coil

PA 12 - Polyamid

Werkstoff:

Polyamid 12

Betriebstemperatur:

-40°C bis +90°C

Betriebsdruck:

siehe Angaben in den Artikeltabellen

Abhängig von der Temperatur – siehe Druckausnutzungsgrad (Richtwert) in %

weichmacherhaltig, für Extrusion, wärmealterungsstabilisiert, lichtstabilisiert

PA 12 – polyamide

material:

Polyamid 12

working temperature:

-40°C up to +90°C

working pressure:

look at the information at the product charts

depending on temperature - look at pressure utilisation level (guideline) in %

contains softener, for extrusion, heat aging and light stabilized

Temp.-Bereich	-60°C bis +23°C	+30°C	+40°C	+50°C	+60°C	+70°C	+80°C	+90°C	+100°C
temp.-range	-60°C up to +23°C	+30°C	+40°C	+50°C	+60°C	+70°C	+80°C	+90°C	+100°C
Ausnutzungsgrad	100%	87%	74%	64%	57%	52%	47%	44%	36%
utilisation level	100%	87%	74%	64%	57%	52%	47%	44%	36%

schwarz/black

Außen-Ø/mm outer-Ø/mm	Wandstärke/mm thickness/mm	DIN	Betriebsdruck (20°) working pressure (20°)	Biegeradius/mm bend radius/mm	Länge length	Art.-Nr.
4	0,65	73378	20	20	100 m	672 025
4	1	73378	45	20	100 m	672 018
5	1	73378	35	25	100 m	672 016
6	1	74324	27	30	25 m	672 051
6	1	74324	27	30	100 m	672 001
6	1	74324	27	30	2100 m*	672 091 03
6	1,5	73378	45	30	25 m	672 052
6	1,5	73378	45	30	100 m	672 002
6	2	73378	110		100 m	672 024
8	1	74324	19	50	25 m	672 053
8	1	74324	19	50	100 m	672 003
8	1	74324	19	50	1300 m*	672 093 01
8	1,5	73378	31	40	25 m	672 054
8	1,5	73378	31	40	100 m	672 004
9	1,5	74324	27	45	25 m	672 063
9	1,5	74324	27	45	100 m	672 013
10	1	74324	15	60	25 m	672 055
10	1	74324	15	60	100 m	672 005
10	1	74324	15	60	650 m*	672 095 01
10	1,25	74324	19	60	100 m	672 017
10	1,5	73378	23	60	25 m	672 058
10	1,5	73378	23	60	100 m	672 008
11	1,5	74324	21	55	25 m	672 060
11	1,5	74324	21	55	100 m	672 010
12	1	73378	12	85	100 m	672 009
12	1,5	74324	19	60	25 m	672 056
12	1,5	74324	19	60	100 m	672 006
12	1,5	74324	19	60	500 m*	672 096 01
12,5	1,25	74324	26	60	100 m	672 021
13	1,5	73378	17	60	100 m	672 023
14	1,5	74324	16	80	100 m	672 026
14	2	74324	22	75	100 m	672 014
15	1,5	74324	12	90	25 m	672 057
15	1,5	74324	12	90	100 m	672 007
15	1,5	74324	12	90	300 m*	672 097 01
16	2	74324	19	95	50 m	672 015
18	2	73378	16	120	50 m	672 011
22	2	73378	13	150	50 m	672 019

Polyamidrohr

polyamide pipe

PA 12 - Polyamid

Werkstoff: Polyamid 12
Betriebstemperatur: -40°C bis +90°C
Betriebsdruck: siehe Angaben in den Artikeltabellen
 Abhängig von der Temperatur – siehe Druckausnutzungsgrad (Richtwert) in %
 weichmacherhaltig, für Extrusion, wärmealterungsstabilisiert, lichtstabilisiert

PA 12 – polyamide

material: Polyamid 12
working temperature: -40°C up to +90°C
working pressure: look at the information at the product charts
 depending of the temperature - look at pressure utilisation level (guideline) in %
 contains softener, for extrusion, heat aging and light stabilized



Temp.-Bereich	-60°C bis +23°C	+30°C	+40°C	+50°C	+60°C	+70°C	+80°C	+90°C	+100°C
temp.-range	-60°C up to +23°C	+30°C	+40°C	+50°C	+60°C	+70°C	+80°C	+90°C	+100°C
Ausnutzungsgrad	100%	87%	74%	64%	57%	52%	47%	44%	36%
utilisation level	100%	87%	74%	64%	57%	52%	47%	44%	36%

natur/nature

Außen-Ø/mm outer-Ø/mm	Wandstärke/mm thickness/mm	DIN	Betriebsdruck (20°) working pressure (20°)	Biegeradius/mm bend radius/mm	Länge length	Art.-Nr.
3	0,65	73378	35	15	100 m	672 124
4	0,65	73378	20	20	100 m	672 125
4	1	73378	45	20	100 m	672 100
4,3	0,85	73378	20	20	100 m	672 126
5	1	73378	35	25	100 m	672 127
5	1,5	73378	45	32	100 m	672 115
6	1	73378	27	30	100 m	672 101
8	1	73378	19	50	100 m	672 103
8	1,5	73378	30	40	100 m	672 104
10	1	73378	15	60	100 m	672 105
10	1,5	73378	24	50	100 m	672 117
12	1	73378	12	85	100 m	672 109
12	1,5	73378	19	60	100 m	672 106
14	1,5	73378	16	80	100 m	672 128
15	1,5	73378	12	90	100 m	672 107

Polyamidrohr-Abschneider

polyamide pipe cutter

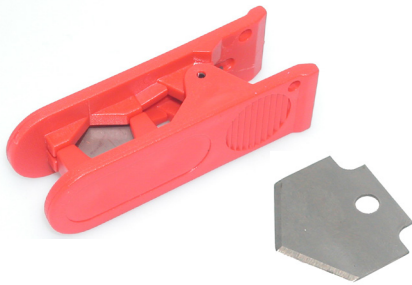

für Poly-Rohr Abmessungen for poly pipe dimension	Bezeichnung description	Art.-Nr.
4-12 mm	Polyamid-Rohrabschneider	209 010
	Ersatzmesser	209 027

Polyamidrohr-Schneidzangen

polyamide pipe cutting pliers



für Poly-Rohr Abmessungen for poly pipe dimension	Bezeichnung description	Art.-Nr.
4-22 mm	Polyamid-Rohrabschneider	209 013
	Ersatzmesser	209 028
	Ersatzmesser (alte Ausführung vor 16.02.87)	209 026

Polyamidrohr-Montagezangen

polyamide pipe assembly pliers



für Poly-Rohr Abmessungen for poly pipe dimension	Art.-Nr.
6, 8, 10, 11 mm	209 011
7, 9 12 mm	209 012
14, 15, 16 mm	209 014

Einschlagnippel für Polyamidrohr impaction nipples for polyamide pipe

Kugelbuchse für 24° und 60° Aussenkung, ähnlich DIN 3868

Werkstoff: Stahl

Oberflächenschutz: verzinkt

spherical for 24° and 60° recess, similar to DIN 3868

material: steel

surface protection: galvanized

für Schlauch Innen-Ø for hose internal-Ø mm (d1)	passend für Überwurfmutter suitable for union nut	l2 mm	D mm	Bezeichnung description	Art.-Nr.
4	M 10X1 / R 1/8"	13	6,5	N 2 F.ID 4 mm PO	205 353
4	M 12X1,5 / R 1/4"	12,5	7,5	N 4:2 F.ID 4 mm PO	205 357
5	M 12X1,5 / R 1/4"	13	7,5	N 4 F.ID 5 mm PO	205 356
5	M 14X1,5 / R 1/4"	13	9,5	N 6:4 F.ID 5 mm PO	205 351
6	M 14X1,5 / R 1/4"	13	9,5	N 6 F.ID 6 mm PO	205 350
6	M 16X1,5 / R 3/8"	13	11,5	N 8:6 F.ID 6 mm PO	205 354
6	M 18X1,5 / R 1/2"	13	13,5	N 10:6 F.ID 6 mm PO	205 360
8	M 16X1,5 / R 3/8"	14	11,5	N 8 F.ID 8 mm PO	205 352
9	M 16X1,5 / R 3/8"	12,5	11,5	N 8:10 F.ID 9 mm PO	205 355
9	M 18X1,5 / R 1/2"	12	13,5	N 10 F.ID 9 mm PO	205 358
12	M 22X1,5	12	17	N 13 F.ID 12 mm PO	205 359

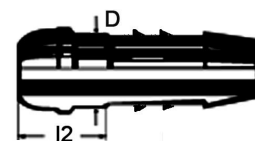

Überwurfmuttern - metrisch union nuts - metrical

DIN 3870 B

Werkstoff: Stahl

Oberflächenschutz: verzinkt

material: steel

surface protection: galvanized

Nennweite nominal size	Gewinde d2 thread d2	Schlüsselweite width across flats	d1 mm	l mm	Bezeichnung description	Art.-Nr.
2	M 10X1	12	6,5	11	U 2	203 802
4	M 12X1,5	14	7,5	14,5	U 4	203 804
6	M 14X1,5	17	9,5	14,5	U 6	203 806
8	M 16X1,5	19	11,5	15,5	U 8	203 808
10	M 18X1,5	22	13,5	15,5	U 10	203 810
12	M 22X1,5	27	17	17	U 13	203 813

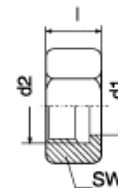

Überwurfmuttern - zöllig union nuts - inch

Werkstoff: Stahl

Oberflächenschutz: verzinkt

material: steel

surface protection: galvanized

Nennweite nominal size	Gewinde d2 thread d2	Schlüsselweite width across flats	d1 mm	l mm	Bezeichnung description	Art.-Nr.
2	R 1/8"	14	6,5	11	UZ 2	203 902
4	R 1/4"	17	7,5	14	UZ 4	203 904
6	R 1/4"	17	9,5	14	UZ 6	203 906
8	R 3/8"	19	11,5	14	UZ 8	203 908
10	R 1/2"	27	13,5	14	UZ 10	203 910
12	R 5/8"	27	17	16	UZ 13	203 913

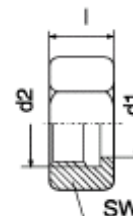

Ringnippel für Polyamidrohr

union nuts - inch

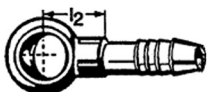

mit Schlüsselfläche

Werkstoff: Stahl

Oberflächenschutz: verzinkt

with flat

material: steel

surface protection: galvanized

für Polyrohr Innen-Ø for poly pipe internal-Ø mm	Ringauge-Ø ring hole-Ø mm	l2	Höhe high mm	Bezeichnung description	Art.-Nr.
4	6	8	8	R 1 f.ID 4 mm PO	205 525
4	8	8	8	R 2 f.ID 4 mm PO	205 509
5	8	8	8	R 2 f.ID 5 mm PO	205 513
4	10	9	10	R 4 f.ID 4 mm PO	205 510
6	10	10,5	10	R 4 f.ID 6 mm PO	205 505
4	12	11	12	R 6 f.ID 4 mm PO	205 524
5	12	11,5	12	R 6 f.ID 5 mm PO	205 517
6	12	12	12	R 6 f.ID 6 mm PO	205 518
8	12	12,5	12	R 6 f.ID 8 mm PO	205 504
4	14	13	14	R 8 f.ID 4 mm PO	205 503
5	14	13	14	R 8 f.ID 5 mm PO	205 526
6	14	14	14	R 8 f.ID 6 mm PO	205 512
7	14	12	14	R 8 f.ID 7 mm PO	205 527
8	14	14,5	14	R 8 f.ID 8 mm PO	205 506
9	14	16	14	R 8 f.ID 9 mm PO	205 514
4	16	15	16	R 10 f.ID 4 mm PO	205 502
6	16	16	16	R 10 f.ID 6 mm PO	205 507
8	16	16	16	R 10 f.ID 8 mm PO	205 501
9	16	16	16	R 10 f.ID 9 mm PO	205 500
12	18	20,5	20	R 13 f.ID 12 mm PO	205 519

Außengewinde Polyamidrohrnippel - metrisch 24°

external thread polyamide pipe nipples - metrical 24°

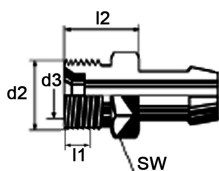

leichte Baureihe

Anschlussart: Stutzen mit 24° Aussenkung passend für Rohrverschraubungen DIN 2353 und DKL/DKOL

Werkstoff: Stahl

Oberflächenschutz: verzinkt

light series

kind of connection: connecting piece with 24° counter sinking suitable for pipe joints DIN 2353 and DKL/DKOL

material: steel

surface protection: galvanized

für Polyrohr Innen-Ø for poly pipe internal-Ø mm	Außengewinde external thread (d2)	Rohranschluss pipe connection (d3)	l2	SW mm	Bezeichnung description	Art.-Nr.
4	M 12X1,5	6	14,5	14	CEL06 f.ID 4 mm PO	205 420
5	M 12X1,5	6	15	14	CEL06 f.ID 5 mm PO	205 421
6	M 14X1,5	8	14,5	17	CEL08 f.ID 6 mm PO	205 423
8	M 14X1,5	8	14,5	17	CEL08 f.ID 8 mm PO	205 424
8	M 16X1,5	10	16	19	CEL10 f.ID 8 mm PO	205 425
9	M 16X1,5	10	16	19	CEL10 f.ID 9 mm PO	205 426
9	M 18X1,5	12	17	19	CEL12 f.ID 9 mm PO	205 427
12	M 22X1,5	15	20	24	CEL15 f.ID 12 mm PO	205 428

Polyamidrohrnippel BE für Schneidringanschluss

polyamide pipe nipples BE for cutting ring connection

leichte Baureihe

Werkstoff: Stahl

Oberflächenschutz: verzinkt

light series

material: steel

surface protection: galvanized

für Polyrohr Innen-Ø for poly pipe internal-Ø mm	Rohranschluss pipe connection (d3)	I2	Bezeichnung description	Art.-Nr.
4	6	20	BE 6 f.ID 4 mm PO	205 400
5	6	21	BE 6 f.ID 5 mm PO	205 401
5	8	22	BE 8 f.ID 5 mm PO	205 402
6	8	22	BE 8 f.ID 6 mm PO	205 403
8	8	24	BE 8 f.ID 8 mm PO	205 404
8	10	26	BE 10 f.ID 8 mm PO	205 405
9	10	27	BE 10 f.ID 9 mm PO	205 406
9	12	26	BE 12 f.ID 9 mm PO	205 407
12	15	26	BE 15 f.ID 12 mm PO	205 408

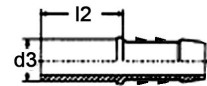

Überwurfmuttern

union nuts

DIN 3870A

sehr leichte Baureihe

very light series

Baureihe series	PN bar	Rohranschluss pipe connection (d3)	RA	SW mm	Gewinde thread	Art.-Nr.
LL	100	M-LL	4	10	M 8X1	432 100
LL	100	M-LL	5	12	M 10X1	432 101
LL	100	M-LL	6	12	M 10X1	432 102
LL	100	M-LL	8	14	M 12X1	432 103
LL	100	M-LL	10	17	M 14X1	432 104
LL	100	M-LL	12	19	M 16X1	432 105

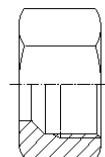

leichte Baureihe

light series

Baureihe series	PN bar	Rohranschluss pipe connection (d3)	RA	Gewinde thread	SW mm	Art.-Nr.
L	315	M-L	6	M 12X1,5	14	432 110
L	315	M-L	8	M 14X1,5	17	432 111
L	315	M-L	9	M 14X1,5	17	432 161
L	315	M-L	10	M 16X1,5	19	432 112
L	315	M-L	11	M 16X1,5	19	432 162
L	315	M-L	12	M 18X1,5	22	432 113
L	315	M-L	15	M 18X1,5	27	432 114

Schneidringe cutting rings



sehr leichte Baureihe very light series

Baureihe series	PN bar	Rohranschluss pipe connection	Bezeichnung description	Art.-Nr.
LL	100	4	SR-LL	432 200
LL	100	5	SR-LL	432 201
LL	100	6	SR-LL	432 202
LL	100	8	SR-LL	432 203
LL	100	10	SR-LL	432 204
LL	100	12	SR-LL	432 205

Schneidringe cutting rings



leichte Baureihe light series

Baureihe series	PN bar	Rohranschluss pipe connection	Bezeichnung description	Art.-Nr.
L	315	6	SR-L/S	432 210
L	315	8	SR-L/S	432 211
L	315	9	SR-L	432 261
L	315	10	SR-L/S	432 212
L	315	11	SR-L	432 262
L	315	12	SR-L/S	432 213
L	315	15	SR-L	432 214

Weitere Größen von Schneidringen und Überwurfmutter für BE Stutzen finden Sie auch in unserem Hydraulikkatalog Teil 1.

Further sizes of cutting rings and union nuts for connecting pieces you find also in our hydraulic catalogue part 1.

gerade Polyamidrohrverbinder straight polyamide connectors



Werkstoff: Messing
material: brass

für Polyrohr Innen-Ø for poly pipe internal-Ø mm	Bezeichnung description	Art.-Nr.
4	G-PO-RV-MS	326 104
6	G-PO-RV-MS	326 106
8	G-PO-RV-MS	326 108
9	G-PO-RV-MS	326 109
12	G-PO-RV-MS	326 112

T-Polyamidrohrverbinder

T polyamide pipe connectors

Werkstoff: Messing
material: brass

für Polyrohr Innen-Ø for poly pipe internal-Ø mm	Bezeichnung description	Art.-Nr.
4	T-PO-RV-MS	326 124
6	T-PO-RV-MS	326 126
8	T-PO-RV-MS	326 128
9	T-PO-RV-MS	326 129



reduzierte T-Polyamidrohrverbinder

reduced T polyamide pipe connectors

Werkstoff: Messing
material: brass

für Polyrohr Innen-Ø for poly pipe internal-Ø mm	Bezeichnung description	Art.-Nr.
6-4-6	T-PO-RV-MS	326 162
8-6-8	T-PO-RV-MS	326 164
9-6-9	T-PO-RV-MS	326 166



Verstärkungshülsen für Polyamidrohr

reinforcement sleeves for polyamide pipe

Werkstoff: Messing
material: brass

für Polyrohr Innen-Ø for poly pipe internal-Ø mm	Bezeichnung description	Art.-Nr.
1,5	VH 2,5X0,5 PO	244 115
2,3	VH 4X0,85 PO	244 118
2,5	VH 4X0,75 PO	244 117
2,7	VH 4X0,65 PO	244 116
2	VH 4X1 PO	244 127
3	VH 6X1,5 PO	244 140
4	VH 6X1 PO	244 120
5	VH 8X1,5 PO	244 141
6	VH 8X1 PO	244 121
7	VH 10X1,5 PO	244 142
7,5	VH 10X1,25 PO	244 132
8	VH 10X1 PO	244 122
9	VH 12X1,5 PO	244 143
10	VH 12X1/12,5X1,25/13X1,5/14X2 PO	244 123
12	VH 15X1,5/16X2 PO	244 144
14	VH 18X2 PO	244 166
18	VH 22X2 PO	244 171



gerade Verschraubungen straight screw connections



sehr leichte Baureihe

Werkstoff: Stahl
Oberflächenschutz: verzinkt

very light series

material: steel
surface protection: galvanized

Baureihe series	PN bar	Rohranschluss pipe connection	Gewinde thread	Bezeichnung description	Art.-Nr.
LL	100	4	M 8X1	G-LL	430 100
LL	100	5	M 10X1	G-LL	430 101
LL	100	6	M 10X1	G-LL	430 102
LL	100	8	M 12X1	G-LL	430 103
LL	100	10	M 14X1	G-LL	430 104
LL	100	12	M 16X1	G-LL	430 105
LL	100	16	M 22X1,5	G-LL	430 106

leichte Baureihe

light series

Baureihe series	PN bar	Rohranschluss pipe connection	Gewinde thread	Bezeichnung description	Art.-Nr.
L	315	6	M 12X1,5	G-L	430 110
L	315	8	M 14X1,5	G-L	430 111
L	315	9	M 14X1,5	G-L	304 132
L	315	10	M 16X1,5	G-L	430 112
L	315	11	M 16X1,5	G-L	304 133
L	315	12	M 18X1,5	G-L	430 113
L	315	13,25	M 20X1,5	G-L	304 134
L	315	15	M 22X1,5	G-L	430 114
L	315	18	M 26X1,5	G-L	430 115
L	160	22	M 30X2	G-L	430 116

schwere Baureihe

heavy series

Baureihe series	PN bar	Rohranschluss pipe connection	Gewinde thread	Bezeichnung description	Art.-Nr.
S	630	6	M 14X1,5	G-S	430 120
S	630	8	M 16X1,5	G-S	430 121
S	630	10	M 18X1,5	G-S	430 122
S	630	12	M 20X1,5	G-S	430 123
S	630	14	M 22X1,5	G-S	430 124
S	400	16	M 24X1,5	G-S	430 125
S	400	20	M 30X2	G-S	430 126

Verbinder Sätze für Polyamidrohr connection sets for polyamide pipes



Rohranschluss pipe connection	Ref.-Nr. DC	Bezeichnung description	Art.-Nr.
4		Verbindersatz 4 mm	301 207
5		Verbindersatz 5 mm	301 209
6	003 997 9172	Verbindersatz 6 mm	301 200
8	002 990 5971	Verbindersatz 8 mm	301 201
10	004 997 1672	Verbindersatz 10 mm	301 202
12		Verbindersatz 12 mm	301 203
15		Verbindersatz 15 mm	301 204
18		Verbindersatz 18 mm	301 205
22		Verbindersatz 22 mm	301 206

gerade Steckverbinder

straight plug connectors

lösbar

Technische Daten:

Werkstoff:

Gehäuse Messing, vernickelt, Dichtungen aus NBR silikonfrei, Spann-
zange aus Edelstahl AISI316, Druckring aus HOSTAFORM schwarz

Betriebsdruck:

max. 16 bar bei 20° C

Medium:

Druckluft

Temperaturbereich:

-20° C bis +70° C

unlockable

technical data:

surfacing material:

Case brass, nickel plates, seals from NBR silicone-free, collet chuck
made of high-grade steel AISI316, thrust ring out HOSTAFORM black

operating pressure:

maximum 16 bar with 20° C

medium:

compressed air

temperature range:

-20° C to +70° C

für Polyrohr Außen-Ø for poly pipe external-Ø mm	Bezeichnung description	Art.-Nr.
4	G 4 SV	249 20 03 01
5	G 5 SV	249 20 03 02
6	G 6 SV	249 20 03 03
8	G 8 SV	249 20 03 04
10	G 10 SV	249 20 03 05
12	G 12 SV	249 20 03 06
14	G 14 SV	249 20 03 07



gerade Schottsteckverbinder

straight bulkhead plug connectors

lösbar

unlockable

für Polyrohr Außen-Ø
for poly pipe external-Ø
mm

Bezeichnung
description

Art.-Nr.

4	G 4 SV Schott	249 20 11 01
5	G 5 SV Schott	249 20 11 02
6	G 6 SV Schott	249 20 11 03
8	G 8 SV Schott	249 20 11 04
10	G 10 SV Schott	249 20 11 05
12	G 12 SV Schott	249 20 11 06
14	G 14 SV Schott	249 20 11 07



Winkel-Steckverbinder

angle connectors

lösbar

unlockable

für Polyrohr Außen-Ø
for poly pipe external-Ø
mm

Bezeichnung
description

Art.-Nr.

4	W 4 SV	249 20 04 01
5	W 5 SV	249 20 04 02
6	W 6 SV	249 20 04 03
8	W 8 SV	249 20 04 04
10	W 10 SV	249 20 04 05
12	W 12 SV	249 20 04 06
14	W 14 SV	249 20 04 07

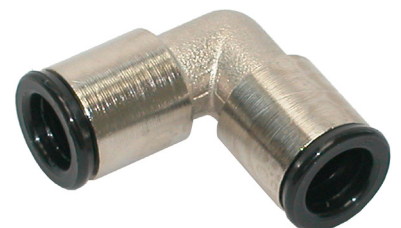

T-Steckverbinder

T-plug connectors



lösbar

unlockable

für Polyrohr Außen-Ø for poly pipe external-Ø mm	Bezeichnung description	Art.-Nr.
4	T 4 SV	249 20 05 01
5	T 5 SV	249 20 05 02
6	T 6 SV	249 20 05 03
8	T 8 SV	249 20 05 04
10	T 10 SV	249 20 05 05
12	T 12 SV	249 20 05 06
14	T 14 SV	249 20 05 07

gerade Steck Einschraubverschraubungen

straight plug male couplings

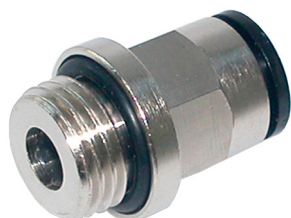

lösbar

Technische Daten:

Werkstoff:

Gehäuse Messing, vernickelt, Dichtungen aus NBR silikonfrei, Spann-
zange aus Edelstahl AISI316, Druckring aus HOSTAFORM schwarz

Betriebsdruck:

max. 16 bar bei 20° C

Medium:

Druckluft

Temperaturbereich:

-20° C bis +70° C

unlockable

technical data:

surfacing material:

case brass, nickel plates, seals from NBR silicone-free, collet chuck
made of high grade steel AISI316, thrust ring out HOSTAFORM black

operating pressure:

maximum 16 bar with 20° C

medium:

compressed air

temperature range:

-20° C to +70° C

für Polyrohr Außen-Ø for poly pipe external-Ø mm	Einschraubgewinde screw-in thread	Bezeichnung description	Art.-Nr.
6	M 10X1 K	G-ES 6-10X1K SV	249 20 01 30
6	M 12X1,25	G-ES 6-12X1,25 SV	249 20 01 31
4	G 1/8"	G-ES 4-1/8" SV	249 20 01 02
4	G 1/4"	G-ES 4-1/4" SV	249 20 01 03
5	G 1/8"	G-ES 5-1/8" SV	249 20 01 05
5	G 1/4"	G-ES 5-1/4" SV	249 20 01 06
6	G 1/8"	G-ES 6-1/8" SV	249 20 01 07
6	G 1/4"	G-ES 6-1/4" SV	249 20 01 08
6	G 3/8"	G-ES 6-3/8" SV	249 20 01 18
8	G 1/8"	G-ES 8-1/8" SV	249 20 01 09
8	G 1/4"	G-ES 8-1/4" SV	249 20 01 10
8	G 3/8"	G-ES 8-3/8" SV	249 20 01 11
8	G 1/2"	G-ES 8-1/2" SV	249 20 01 33
10	G 1/8"	G-ES 10-1/8" SV	249 20 01 29
10	G 1/4"	G-ES 10-1/4" SV	249 20 01 12
10	G 3/8"	G-ES 10-3/8" SV	249 20 01 13
10	G 1/2"	G-ES 10-1/2" SV	249 20 01 35
12	G 1/4"	G-ES 12-1/4" SV	249 20 01 19
12	G 3/8"	G-ES 12-3/8" SV	249 20 01 14
12	G 1/2"	G-ES 12-1/2" SV	249 20 01 15
14	G 3/8"	G-ES 14-3/8" SV	249 20 01 16
14	G 1/2"	G-ES 14-1/2" SV	249 20 01 17

Winkel Steck Einschraubverschraubungen angle plug male couplings

360° drehbar, lösbar
360° pivoting, unlockable

für Polyrohr Außen-Ø for poly pipe external-Ø mm	Einschraubgewinde screw-in thread	Bezeichnung description	Art.-Nr.
4	M 10X1 K	W-ES 4-10X1K SV	249 20 22 32
6	M 10X1 K	W-ES 6-10X1K SV	249 20 22 33
6	M 12X1,25	W-ES 6-12X1,5 SV	249 20 22 18
6	M 12X1,5	W-ES 6-12X1,5 SV	249 20 22 22
8	M 10X1 K	W-ES 8-10X1K SV	249 20 22 35
4	G 1/8"	W-ES 4-1/8" SV	249 20 22 01
4	G 1/4"	W-ES 4-1/4" SV	249 20 22 02
5	G 1/8"	W-ES 5-1/8" SV	249 20 22 28
5	G 1/4"	W-ES 5-1/4" SV	249 20 22 30
6	G 1/8"	W-ES 6-1/8" SV	249 20 22 03
6	G 1/4"	W-ES 6-1/4" SV	249 20 22 04
8	G 1/8"	W-ES 8-1/8" SV	249 20 22 05
8	G 1/4"	W-ES 8-1/4" SV	249 20 22 06
8	G 3/8"	W-ES 8-3/8" SV	249 20 22 07
10	G 1/4"	W-ES 10-1/4" SV	249 20 22 08
10	G 3/8"	W-ES 10-3/8" SV	249 20 22 09
10	G 1/2"	W-ES 10-1/2" SV	249 20 22 24
12	G 1/4"	W-ES 12-1/4" SV	249 20 22 10
12	G 3/8"	W-ES 12-3/8" SV	249 20 22 11
12	G 1/2"	W-ES 12-1/2" SV	249 20 22 12
14	G 3/8"	W-ES 14-3/8" SV	249 20 22 13
14	G 1/2"	W-ES 14-1/2" SV	249 20 22 14

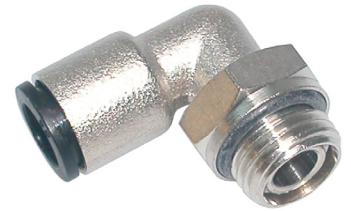

L-Steck Einschraubverschraubungen L-plug male couplings

360° drehbar, lösbar
360° pivoting, unlockable

für Polyrohr Außen-Ø for poly pipe external-Ø mm	Einschraubgewinde screw-in thread	Bezeichnung description	Art.-Nr.
4	G 1/8"	L-ES 4-1/8" SV	249 20 21 01
4	G 1/4"	L-ES 4-1/4" SV	249 20 21 02
6	G 1/8"	L-ES 6-1/8" SV	249 20 21 03
6	G 1/4"	L-ES 6-1/4" SV	249 20 21 04
8	G 1/8"	L-ES 8-1/8" SV	249 20 21 05
8	G 1/4"	L-ES 8-1/4" SV	249 20 21 06
8	G 3/8"	L-ES 8-3/8" SV	249 20 21 07
10	G 1/4"	L-ES 10-1/4" SV	249 20 21 08
10	G 3/8"	L-ES 10-3/8" SV	249 20 21 09
12	G 1/4"	L-ES 12-1/4" SV	249 20 21 10
12	G 3/8"	L-ES 12-3/8" SV	249 20 21 11
14	G 1/2"	L-ES 14-1/2" SV	249 20 21 12

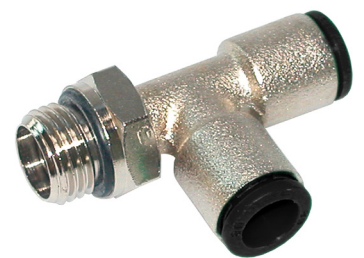

T-Steck Einschraubverschraubungen

T-plug male couplings



360° drehbar, lösbar

Technische Daten:

Werkstoff:

Gehäuse Messing, vernickelt, Dichtungen aus NBR silikonfrei, Spann-
zange aus Edelstahl AISI316, Druckring aus HOSTAFORM schwarz

Betriebsdruck:

max. 16 bar bei 20° C

Medium:

Druckluft

Temperaturbereich:

-20° C bis +70° C

360° pivoting, unlockable

technical data:

surfacing material:

case brass, nickel plates, seals from NBR silicone-free, collet chuck
made of high grade steel AISI316, thrust ring out HOSTAFORM black

operating pressure:

maximum 16 bar with 20° C

medium:

compressed air

temperature range:

-20° C to +70° C

für Polyrohr Außen-Ø for poly pipe external-Ø mm	Einschraubgewinde screw-in thread	Bezeichnung description	Art.-Nr.
4	G 1/8"	T-ES 4-1/8" SV	249 20 20 02
4	G 1/4"	T-ES 4-1/4" SV	249 20 20 03
6	G 1/8"	T-ES 6-1/8" SV	249 20 20 04
6	G 1/4"	T-ES 6-1/4" SV	249 20 20 05
8	G 1/8"	T-ES 8-1/8" SV	249 20 20 06
8	G 1/4"	T-ES 8-1/4" SV	249 20 20 07
8	G 3/8"	T-ES 8-3/8" SV	249 20 20 08
10	G 1/4"	T-ES 10-1/4" SV	249 20 20 09
10	G 3/8"	T-ES 10-3/8" SV	249 20 20 10
12	G 1/4"	T-ES 12-1/4" SV	249 20 20 11
12	G 3/8"	T-ES 12-3/8" SV	249 20 20 12
14	G 1/2"	T-ES 14-1/2" SV	249 20 20 16

gerade Verschraubungen

straight screw connections



für zöllige Rohre

for inch pipes

Werkstoff: Messing

material: brass

für Polyrohr Außen-Ø for poly pipe external-Ø mm	für Poly-Rohr for poly-pipe	Art.-Nr.
3,17	R 1/8"	307 110
4,75	R 3/16"	307 111
6,35	R 1/4"	307 112
9,52	R 3/8"	307 113
12,7	R 1/2"	307 114

Dichtringe

Sealing rings

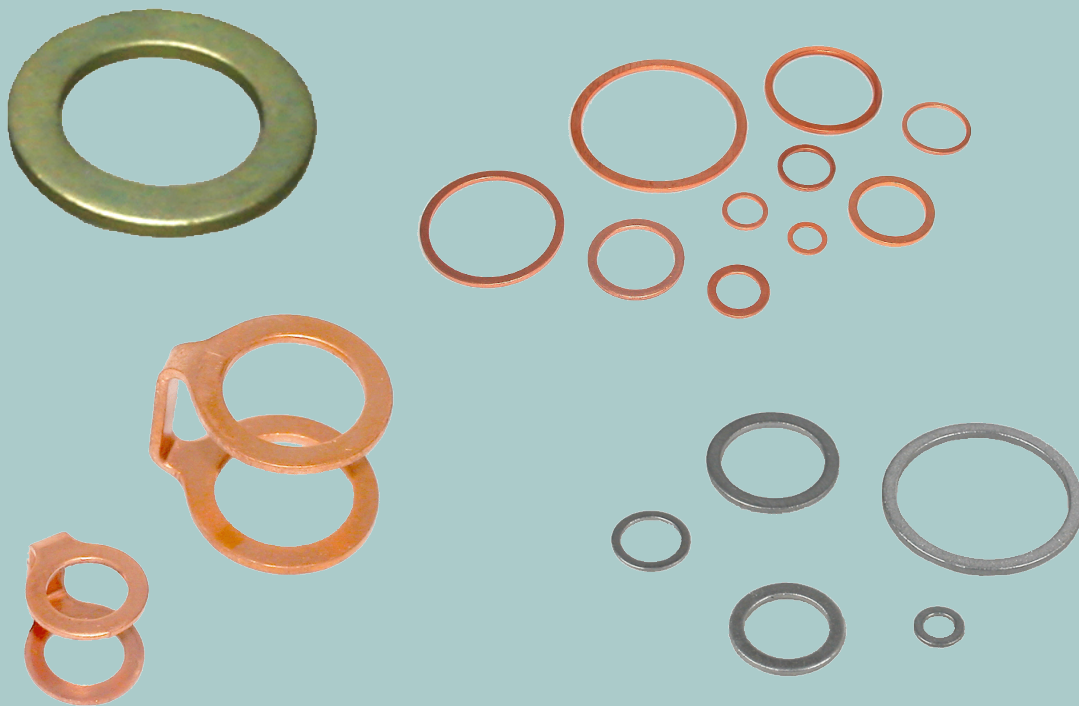

Flachdichtringe DIN 7603

- Kupfer
- Aluminium
- Fiber
- Zink

Kupfer-Füllringe

U-Seal Dichtringe

O-Ringe metrisch und zöllig

70 Shore

90 Shore

Viton

flat sealing rings DIN 7603

- copper
- aluminium
- fiber
- zinc

copper filling rings

U-seal rings

O-rings metrical and inch

70 shore

90 shore

viton



Flachdichtringe Form A nach DIN 7603

Werkstoff: SF-Cu, auf eine Härte von max. 45 HB weichgeglüht

Betriebstemperatur: nach DIN max. +300° C

flat sealing rings form A according to DIN 7603

material: SF-Cu, on a hardness annealed by 45 HB max

working temperature: according to DIN max. +300° C

Abmessungen dimensions	Art.-Nr.
4X8X1	100 501
5X9X1	100 503
5X11X1	100 504
6X10X1	100 505
6X12X1	100 506
7,4X12X1	100 700
8X11,5X1	190 506
8X12X1	100 514
8X12X1,5	100 515
8X14X1	100 517
8X14X1,5	100 518
8X14X2	100 519
10X14X1	100 531
10X14X1,5	100 532
10X14X2	100 533
10X16X1	100 536
10X16X1,5	100 537
10X16X2	100 538
10X18X1	100 540
10X18X1,5	100 541
10X19X2	100 543
12X16X1	100 547
12X16X1,5	100 548
12X17X1,5	100 551
12X18X1	100 553
12X18X1,5	100 554
12X18X2	100 555
12X20X2	100 558
13X18X1	100 562
13X18X1,5	100 563
13X18X2	100 564
14X18X1	100 567
14X18X1,5	100 568
14X18X2	100 569
14X20X1	100 571
14X20X1,5	100 572
14X20X2	100 573
14X21X1,5	100 574
14X22X1,5	100 576
15X20X1,5	100 580
15X21X1,5	100 581
15X24X1,5	100 582
16X19,5X1	130 156
16X20X1,5	100 585
16X22X1	100 587
16X22X1,5	100 588
16X24,5X1,5	100 590
17X21X1,5	100 591
17X23X1,5	100 593

Abmessungen dimensions	Art.-Nr.
18X22X1,5	100 597
18X24X1,5	100 601
18X24X2	100 602
20X24X1,5	100 608
20X26X1,5	100 610
20X26X2	100 611
20X28X1,5	100 612
21X26X1,5	100 616
21X27X1,5	100 619
21X28X1,5	100 621
22X26X1,5	100 624
22X27X1,5	100 627
22X27X2	100 628
22X28X1,5	100 629
22X28X2	100 630
22X29X1,5	100 631
24X28X1,5	100 639
24X29X2	100 641
24X30X2	100 643
24X32X2	100 644
26,1X29X1	130 157
26X31X2	100 648
26X32X2	100 651
26X34X2	100 652
27X32X2	100 656
28X34X2	100 658
28X36X2	100 659
30X36X2	100 662
30X38X2	100 663
32X38X2	100 664
33X39X2	100 668
33X41X2	100 670
34X40X2	100 671
35X41X2	100 672
36X42X2	100 673
36X44X2	100 674
38X44X2	100 677
40X47X2	100 680
42X49X2	100 683
45X52X2	100 687
48X55X2	100 690
50X57X2	100 691
52X60X2,5	100 692
56X64X2,5	100 693
60X68X2,5	100 695
64X72X2,5	100 694

Auch im Sortiment lieferbar.
Also available in the assortment.

Kupfer-Dichtringe copper sealing rings

Form C nach DIN 7603

Werkstoff: SF-Cu, als 0,3 mm dicke Ummantelung und einem astbestfreien Füllstoff aus hochtemperaturbeständigen, mineralischen und keramischen Fasern

Betriebstemperatur: nach DIN max. +250° C

form C according to DIN 7603

material: SF-Cu, as 0,3 mm thick sheathing and a asbestos-free filler from high temperature resistant, mineral and ceramic fiber

working temperature: according to DIN max. +250° C

Abmessungen dimensions	Art.-Nr.
6X10X1,5	100 302
8X12X1,5	100 305
8X14X1,5	100 306
10X16X1,5	100 308
12X6X2	100 309
12X18X2	100 310
14X20X2	100 313
16X20X2	100 316
16X22X2	100 317
16X24X2	100 318
17X23X2	100 321
18X24X2	100 320
20X26X2	100 324
21X26X2	100 325
22X29X2	100 327

Abmessungen dimensions	Art.-Nr.
24X32X2,5	100 330
26X32X2,5	100 331
27X32X2,5	100 334
28X36X2,5	100 336
30X36X2,5	100 337
33X39X2,5	100 340
35X41X2,5	100 341
36X42X2,5	100 342
38X44X2,5	100 344
40X47X2,5	100 345
42X49X2,5	100 346
45X52X2,5	100 348
48X55X2,5	100 349
52X60X3	100 352
60X68X3	100 353



Auch im Sortiment lieferbar.
Also available in the assortment.

Kupfer-Dichtringe Zwilling copper sealing twin rings

Zur Montage von 2 Dichtringen gleichzeitig unter schwierigen Bedingungen

Werkstoff: SF-Cu, Zwillingsringe bestehen aus 2 Dichtringen der Form A, die durch einen Steg miteinander verbunden sind

Betriebstemperatur: nach DIN max. +300° C

for the assembly of 2 sealing rings at the same time under difficult conditions

material: SF-Cu, twin rings consist of 2 sealing rings of the form A, which are connected by a bar

working temperature: according to DIN max. +300° C

Abmessungen dimensions	Abstand/mm distance/mm	Art.-Nr.
6X11X1 Ku-ZW	8	100 805
8X12X1 Ku-ZW	8	100 801
8X12X1 Ku-ZW	13	100 802
14X20X1,5 Ku-ZW	14	100 806



Aluminium-Dichtringe

aluminium sealing rings

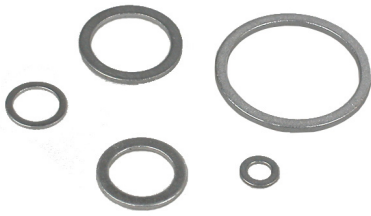

Flachdichtring Form A nach DIN 7603

Werkstoff: AL 99,5 halbhart = F 20, dies entspricht der von der DIN geforderten Härte von 32 - 45 HB

Betriebstemperatur: nach DIN max. +200° C

flat sealing rings form A according to DIN 7603

material: AL 99,5 semi-rigid = F 20, this corresponds to the hardness of 32 - 45 HB, demanded by the DIN

working temperature: according to DIN max. +200° C

Abmessungen dimensions	Art.-Nr.
5X 9X1	100 402
6X10X1	100 404
6X12X1	100 405
8X12X1	100 407
8X14X1	100 409
8X14X1,5	100 410
10X14X1	100 413
10X16X1	100 415
10X16X1,5	100 416
12X16X1,5	100 418
12X18X1,5	100 419
12X20X1,5	100 420
14X18X1,5	100 422
14X20X1,5	100 424
15X24X1,5	100 427
16X20X1,5	100 428
16X22X1,5	100 429
18X22X1,5	100 430
18X24X1,5	100 431

Abmessungen dimensions	Art.-Nr.
20X26X1,5	100 433
22X27X1,5	100 434
22X29X1,5	100 435
24X30X2	100 436
26X32X2	100 439
28X34X2	100 440
30X36X2	100 442
32X38X2	100 444
35X41X2	100 445
36X42X2	100 446
38X44X2	100 447
40X47X2	100 449
42X49X2	100 448
45X52X2	100 450
52X60X2,5	100 451
56X64X2,5	100 452
60X68X2,5	100 453
64X72X2,5	100 454

Auch im Sortiment lieferbar.
Also available in the assortment.

Fiber-Dichtringe

fiber sealing rings



Flachdichtringe Form A nach DIN 7603

Werkstoff: VF Vulcan-Fiber

Betriebstemperatur: nach DIN max. +100° C

flat sealing rings form A according to DIN 7603

material: VF Vulcan-Fiber

working temperature: according to DIN max. +100° C

Abmessungen dimensions	Art.-Nr.
4X8X1	101 001
4,6X10X1	101 071
5X9X1	101 002
5,2X9,8X2	101 072
6X10X1	101 003
6X12X1	101 004
8X12X1	101 007
8X14X1	101 008
10X14X1,5	101 011
10X16X1,5	101 012
12X16X1,5	101 017
12X19X1,5	101 019
12X20X1,5	101 020
14X18X1,5	101 025
14X20X1,5	101 027
15X24X1,5	101 032

Abmessungen dimensions	Art.-Nr.
16X20X1,5	101 034
16X22X1,5	101 035
18X24X1,5	101 038
20X27X3	101 070
22X27X1,5	101 044
22X29X1,5	101 045
26X32X2	101 048
28X34X2	101 051
30X36X2	101 052
32X38X2	101 054
35X41X2	101 056
36X42X2	101 057
38X44X2	101 058
40X47X2	101 060
48X55X7	101 062

Auch im Sortiment lieferbar.
Also available in the assortment.

Zink-Dichtringe

zinc sealing rings

Flachdichtring Form A nach DIN 7603

Werkstoff: Zink 99,532 - 45 HB

Betriebstemperatur: nach DIN max. +300° C

flat sealing rings form A according to DIN 7603

material: zinc 99,5

working temperature: according to DIN max. +300° C



Abmessungen dimensions	Art.-Nr.
12X19X1,5	100 241
15X23X1,5	100 242

U-Seal Dichtringe

U-seal rings

mit Zentrierlippe

Werkstoff: Metallring: Stahl verzinkt; Dichtwulst: NBR-Kautschuk

Betriebstemperatur: -30° C bis +100° C

Metallische Flachdichtung mit innen anvulkanisiertem, trapezförmigem, gummielastischem Dichtwulst zur statischen Abdichtung von Verschraubungen und Flanschverbindungen.

with centering lip

material: metal ring: steel galvanized; sealing bulge: NBR-rubber

working temperature: -30° C to +100° C



Metallic flat sealing with vulcanised, trapezoidal, elastic sealing bulge for the static sealing of screw connections and flange connections.

Abmessungen dimensions	Innen-Ø/mm internal-Ø/mm	Außen-Ø/mm external-Ø/mm	Stärke strength	Art.-Nr.
M 5	5,7	9,0	1,0	431 350
M 6	6,7	11,0	1,0	431 352
M 8	8,7	14,0	1,0	431 356
G 1/8"	10,37	15,88	2,0	431 361
M 10	10,7	16,08	1,5	431 364
M 12	12,7	19,0	1,5	431 365
G 1/4"	13,74	20,57	2,0	431 366
M 14	14,7	22,0	1,5	431 367
M 16	16,7	24,0	1,5	431 369
G 3/8"	17,28	23,8	2,0	431 370
M 18	18,7	26,0	1,5	431 372
G 1/2"	21,54	28,58	2,5	431 374
M 22	22,7	30,0	2,0	431 376
M 24	24,7	32,0	2,0	431 378
M 26 + G 3/4"	27,05	34,93	2,5	431 379
M 33 + G 1"	33,89	42,8	3,2	431 383
G 1 1/4"	42,93	52,38	3,2	431 387
G 1 1/2"	48,44	58,60	3,2	431 388
G 2"	60,58	73,03	3,2	431 389

Auch im Sortiment lieferbar.
Also available in the assortment.

O-Ringe - metrisch

O-rings - metrical



75 Shore

Werkstoff: FKM-Fluorkarbon-Kautschuk

Farbe: grün

Temperatur: -20° C bis + 200° C

75 Shore

material: FKM-fluorocarbon-rubber

colour: green

working temperature: -20° C to +200° C

Innen-Ø mm Inner-Ø mm	Schnur-Ø mm Cord-Ø mm	Art.-Nr.
5	1,0	416 310 005
12	1,0	416 310 012
16	1,0	416 310 016
17	1,0	416 310 017

Innen-Ø mm Inner-Ø mm	Schnur-Ø mm Cord-Ø mm	Art.-Nr.
4	1,5	416 315 004
5	1,5	416 315 005
6	1,5	416 315 006
7	1,5	416 315 007
8	1,5	416 315 008
9	1,5	416 315 009
10	1,5	416 315 010
11	1,5	416 315 011
12	1,5	416 315 012
14	1,5	416 315 014
15	1,5	416 315 015
17	1,5	416 315 017
20	1,5	416 315 020
25	1,5	416 315 025

Innen-Ø mm Inner-Ø mm	Schnur-Ø mm Cord-Ø mm	Art.-Nr.
3	2,0	416 320 003
4	2,0	416 320 004
6	2,0	416 320 006
7	2,0	416 320 007
8	2,0	416 320 008
9	2,0	416 320 009
10	2,0	416 320 010
11	2,0	416 320 011
12	2,0	416 320 012
13	2,0	416 320 013
14	2,0	416 320 014
15	2,0	416 320 015
16	2,0	416 320 016
17	2,0	416 320 017
18	2,0	416 320 018
20	2,0	416 320 020
22	2,0	416 320 022

23	2,0	416 320 023
24	2,0	416 320 024
25	2,0	416 320 025
26	2,0	416 320 026
27	2,0	416 320 027
28	2,0	416 320 028
31	2,0	416 320 031
33	2,0	416 320 033
34	2,0	416 320 034
35	2,0	416 320 035
38	2,0	416 320 038
40	2,0	416 320 040
42	2,0	416 320 042
50	2,0	416 320 050
54	2,0	416 320 054
56	2,0	416 320 056
60	2,0	416 320 060
66	2,0	416 320 066
70	2,0	416 320 070
72	2,0	416 320 072
74	2,0	416 320 074
95	2,0	416 320 095
110	2,0	416 320 110
128	2,0	416 320 128
146	2,0	416 320 146

Innen-Ø mm Inner-Ø mm	Schnur-Ø mm Cord-Ø mm	Art.-Nr.
5	2,5	416 325 005
7	2,5	416 325 007
8	2,5	416 325 008
9	2,5	416 325 009
10	2,5	416 325 010
12	2,5	416 325 012
13	2,5	416 325 013
14	2,5	416 325 014
16	2,5	416 325 016
17	2,5	416 325 017
18	2,5	416 325 018
19	2,5	416 325 019
20	2,5	416 325 020
21	2,5	416 325 021
23	2,5	416 325 023
24	2,5	416 325 024
25	2,5	416 325 025
26	2,5	416 325 026

27	2,5	416 325 027
28	2,5	416 325 028
30	2,5	416 325 030
32	2,5	416 325 032
33	2,5	416 325 033
34	2,5	416 325 034
35	2,5	416 325 035
37	2,5	416 325 037
38	2,5	416 325 038
39	2,5	416 325 039
41	2,5	416 325 041
42	2,5	416 325 042
45	2,5	416 325 045
48	2,5	416 325 048
52	2,5	416 325 052
54	2,5	416 325 054
59	2,5	416 325 059
62	2,5	416 325 062
70	2,5	416 325 070
73	2,5	416 325 073
76	2,5	416 325 076
80	2,5	416 325 080
81	2,5	416 325 081
85	2,5	416 325 085
90	2,5	416 325 090
95	2,5	416 325 095
100	2,5	416 325 100
117	2,5	416 325 117
120	2,5	416 325 120
125	2,5	416 325 125
135	2,5	416 325 135

Innen-Ø mm Inner-Ø mm	Schnur-Ø mm Cord-Ø mm	Art.-Nr.
7	3,0	416 330 007
8	3,0	416 330 008
9	3,0	416 330 009
10	3,0	416 330 010
11	3,0	416 330 011
12	3,0	416 330 012
14	3,0	416 330 014
15	3,0	416 330 015
16	3,0	416 330 016
18	3,0	416 330 018
19	3,0	416 330 019
20	3,0	416 330 020

O-Ringe - metrisch

O-rings - metrical



75 Shore

Werkstoff: FKM

Farbe: grün

Temperatur: -20° C bis + 200° C

75 Shore

material: FKM

colour: green

working temperature: -20° C to +200° C



Innen-Ø mm Inner-Ø mm	Schnur-Ø mm Cord-Ø mm	Art.-Nr.
21	3,0	416 330 021
22	3,0	416 330 022
24	3,0	416 330 024
25	3,0	416 330 025
26	3,0	416 330 026
27	3,0	416 330 027
28	3,0	416 330 028
29	3,0	416 330 029
30	3,0	416 330 030
33	3,0	416 330 033
34	3,0	416 330 034
35	3,0	416 330 035
36	3,0	416 330 036
37	3,0	416 330 037
38	3,0	416 330 038
39	3,0	416 330 039
40	3,0	416 330 040
41	3,0	416 330 041
42	3,0	416 330 042
43	3,0	416 330 043
44	3,0	416 330 044
45	3,0	416 330 045
46	3,0	416 330 046
48	3,0	416 330 048
49	3,0	416 330 049
41	3,0	416 330 051
52	3,0	416 330 052
53	3,0	416 330 053
54	3,0	416 330 054
55	3,0	416 330 055
56	3,0	416 330 056
57	3,0	416 330 057
58	3,0	416 330 058
59	3,0	416 330 059
60	3,0	416 330 060
62	3,0	416 330 062
64	3,0	416 330 064
65	3,0	416 330 065
66	3,0	416 330 066
68	3,0	416 330 068
70	3,0	416 330 070
72	3,0	416 330 072
73	3,0	416 330 073

74	3,0	416 330 074
75	3,0	416 330 075
78	3,0	416 330 078
79	3,0	416 330 079
80	3,0	416 330 080
83	3,0	416 330 083
84	3,0	416 330 084
85	3,0	416 330 085
89	3,0	416 330 089
90	3,0	416 330 090
92	3,0	416 330 092
94	3,0	416 330 094
95	3,0	416 330 095
98	3,0	416 330 098
100	3,0	416 330 100
105	3,0	416 330 105
110	3,0	416 330 110
112	3,0	416 330 112
115	3,0	416 330 115
118	3,0	416 330 118
120	3,0	416 330 120
122	3,0	416 330 122
124	3,0	416 330 124
126	3,0	416 330 126
128	3,0	416 330 128
130	3,0	416 330 130
134	3,0	416 330 134
140	3,0	416 330 140
144	3,0	416 330 144
145	3,0	416 330 145
150	3,0	416 330 150
Innen-Ø mm Inner-Ø mm	Schnur-Ø mm Cord-Ø mm	Art.-Nr.
10	3,5	416 335 010
11	3,5	416 335 011
15	3,5	416 335 015
16	3,5	416 335 016
19	3,5	416 335 019
20	3,5	416 335 020
22	3,5	416 335 022
25	3,5	416 335 025
28	3,5	416 335 028
29	3,5	416 335 029
34	3,5	416 335 034
35	3,5	416 335 035

38	3,5	416 335 038
42	3,5	416 335 042
43	3,5	416 335 043
46	3,5	416 335 046
50	3,5	416 335 050
53	3,5	416 335 053
54	3,5	416 335 054
56	3,5	416 335 056
57	3,5	416 335 057
58	3,5	416 335 058
60	3,5	416 335 060
78	3,5	416 335 078
113	3,5	416 335 113
125	3,5	416 335 125
138	3,5	416 335 138
Innen-Ø mm Inner-Ø mm	Schnur-Ø mm Cord-Ø mm	Art.-Nr.
4	4,0	416 340 004
9	4,0	416 340 009
12	4,0	416 340 012
16	4,0	416 340 016
17	4,0	416 340 017
18	4,0	416 340 018
20	4,0	416 340 020
21	4,0	416 340 021
22	4,0	416 340 022
23	4,0	416 340 023
24	4,0	416 340 024
25	4,0	416 340 025
26	4,0	416 340 026
27	4,0	416 340 027
28	4,0	416 340 028
30	4,0	416 340 030
32	4,0	416 340 032
34	4,0	416 340 034
35	4,0	416 340 035
36	4,0	416 340 036
38	4,0	416 340 038
40	4,0	416 340 040
42	4,0	416 340 042
45	4,0	416 340 045
46	4,0	416 340 046
47	4,0	416 340 047
48	4,0	416 340 048
50	4,0	416 340 050

O-Ringe - metrisch

O-rings - metrical



75 Shore

Werkstoff: FKM

Farbe: grün

Temperatur: -20° C bis + 200° C

75 Shore

material: FKM

colour: green

working temperature: -20° C to +200° C

Innen-Ø mm Inner-Ø mm	Schnur-Ø mm Cord-Ø mm	Art.-Nr.
52	4,0	416 340 052
53	4,0	416 340 053
54	4,0	416 340 054
55	4,0	416 340 055
56	4,0	416 340 056
57	4,0	416 340 057
58	4,0	416 340 058
59	4,0	416 340 059
60	4,0	416 340 060
63	4,0	416 340 063
64	4,0	416 340 064
65	4,0	416 340 065
67	4,0	416 340 067
69	4,0	416 340 069
70	4,0	416 340 070
71	4,0	416 340 071
72	4,0	416 340 072
74	4,0	416 340 074
75	4,0	416 340 075
80	4,0	416 340 080
82	4,0	416 340 082
83	4,0	416 340 083
85	4,0	416 340 085
90	4,0	416 340 090
92	4,0	416 340 092
94	4,0	416 340 094
95	4,0	416 340 095
96	4,0	416 340 096
98	4,0	416 340 098
105	4,0	416 340 105
106	4,0	416 340 106
108	4,0	416 340 108
110	4,0	416 340 110
112	4,0	416 340 112
113	4,0	416 340 113
115	4,0	416 340 115
116	4,0	416 340 116
117	4,0	416 340 117
120	4,0	416 340 120
125	4,0	416 340 125
128	4,0	416 340 128
129	4,0	416 340 129
130	4,0	416 340 130
135	4,0	416 340 135

Innen-Ø mm Inner-Ø mm	Schnur-Ø mm Cord-Ø mm	Art.-Nr.
142	4,0	416 340 142
144	4,0	416 340 144
150	4,0	416 340 150
5	5,0	416 350 005
10	5,0	416 350 010
18	5,0	416 350 018
19	5,0	416 350 019
21	5,0	416 350 021
22	5,0	416 350 022
25	5,0	416 350 025
26	5,0	416 350 026
27	5,0	416 350 027
28	5,0	416 350 028
32	5,0	416 350 032
33	5,0	416 350 033
34	5,0	416 350 034
35	5,0	416 350 035
36	5,0	416 350 036
38	5,0	416 350 038
40	5,0	416 350 040
42	5,0	416 350 042
43	5,0	416 350 043
45	5,0	416 350 045
48	5,0	416 350 048
50	5,0	416 350 050
52	5,0	416 350 052
54	5,0	416 350 054
55	5,0	416 350 055
58	5,0	416 350 058
60	5,0	416 350 060
63	5,0	416 350 063
65	5,0	416 350 065
67	5,0	416 350 067
68	5,0	416 350 068
70	5,0	416 350 070
72	5,0	416 350 072
74	5,0	416 350 074
75	5,0	416 350 075
78	5,0	416 350 078
80	5,0	416 350 080
82	5,0	416 350 082
83	5,0	416 350 083
85	5,0	416 350 085

Innen-Ø mm Inner-Ø mm	Schnur-Ø mm Cord-Ø mm	Art.-Nr.
90	5,0	416 350 090
97	5,0	416 350 097
100	5,0	416 350 100
102	5,0	416 350 102
105	5,0	416 350 105
108	5,0	416 350 108
110	5,0	416 350 110
112	5,0	416 350 112
115	5,0	416 350 115
125	5,0	416 350 125
132	5,0	416 350 132
140	5,0	416 350 140
145	5,0	416 350 145
148	5,0	416 350 148
150	5,0	416 350 150
18	6,0	416 360 018
22	6,0	416 360 022
24	6,0	416 360 024
25	6,0	416 360 025
28	6,0	416 360 028
29	6,0	416 360 029
30	6,0	416 360 030
35	6,0	416 360 035
40	6,0	416 360 040
45	6,0	416 360 045
50	6,0	416 360 050
58	6,0	416 360 058
65	6,0	416 360 065
75	6,0	416 360 075
85	6,0	416 360 085
90	6,0	416 360 090
104	6,0	416 360 104
108	6,0	416 360 108
116	6,0	416 360 116
120	6,0	416 360 120
130	6,0	416 360 130
138	6,0	416 360 138
142	6,0	416 360 142
144	6,0	416 360 144
148	6,0	416 360 148
150	6,0	416 360 150

O-Ringe - zöllig

O-rings - inch

75 Shore

Werkstoff: FKM

Farbe: grün

Temperatur: -20° C bis +200° C

75 Shore

material: FKM

colour: green

working temperature: -20° C to +200° C



Innen-Ø mm Inner-Ø mm	Schnur-Ø mm Cord-Ø mm	Art.-Nr.
2,90	1,78	416 391 006
3,68	1,78	416 391 007
4,47	1,78	416 391 008
6,07	1,78	416 391 009
7,65	1,78	416 391 011
9,25	1,78	416 391 012
10,82	1,78	416 391 013
12,42	1,78	416 391 014
14,00	1,78	416 391 015
15,60	1,78	416 391 016
17,17	1,78	416 391 017
18,77	1,78	416 391 018
21,95	1,78	416 391 020
23,52	1,78	416 391 021
25,12	1,78	416 391 022
29,87	1,78	416 391 025
37,82	1,78	416 391 029
41,00	1,78	416 391 030
44,17	1,78	416 391 031

Innen-Ø mm Inner-Ø mm	Schnur-Ø mm Cord-Ø mm	Art.-Nr.
6,02	2,62	416 393 108
7,59	2,62	416 393 109
9,19	2,62	416 393 110
10,77	2,62	416 393 111
13,94	2,62	416 393 113
15,54	2,62	416 393 114
17,12	2,62	416 393 115
18,72	2,62	416 393 116
20,29	2,62	416 393 117
21,89	2,62	416 393 118
23,47	2,62	416 393 119
25,07	2,62	416 393 120
26,64	2,62	416 393 121
28,24	2,62	416 393 122
29,82	2,62	416 393 123
31,42	2,62	416 393 124
32,99	2,62	416 393 125
34,59	2,62	416 393 126
36,17	2,62	416 393 127
37,77	2,62	416 393 128
39,34	2,62	416 393 129

42,52	2,62	416 393 131
44,12	2,62	416 393 132
45,69	2,62	416 393 133
47,29	2,62	416 393 134
48,90	2,62	416 393 135
50,47	2,62	416 393 136
52,07	2,62	416 393 137
53,64	2,62	416 393 138
55,25	2,62	416 393 139
56,82	2,62	416 393 140
58,42	2,62	416 393 141
59,99	2,62	416 393 142
64,77	2,62	416 393 145
66,34	2,62	416 393 146
67,95	2,62	416 393 147
69,52	2,62	416 393 148
72,69	2,62	416 393 150
75,87	2,62	416 393 151
82,22	2,62	416 393 152
101,27	2,62	416 393 155
120,32	2,62	416 393 158
158,42	2,62	416 393 164
171,12	2,62	416 393 166

Innen-Ø mm Inner-Ø mm	Schnur-Ø mm Cord-Ø mm	Art.-Nr.
13,87	3,53	416 395 207
15,47	3,53	416 395 208
17,04	3,53	416 395 209
18,64	3,53	416 395 210
20,22	3,53	416 395 211
21,82	3,53	416 395 212
23,39	3,53	416 395 213
26,57	3,53	416 395 215
28,17	3,53	416 395 216
29,74	3,53	416 395 217
31,34	3,53	416 395 218
32,92	3,53	416 395 219
34,52	3,53	416 395 220
36,09	3,53	416 395 221
37,69	3,53	416 395 222
40,87	3,53	416 395 223
44,04	3,53	416 395 224
47,22	3,53	416 395 225
53,57	3,53	416 395 227
56,74	3,53	416 395 228
63,09	3,53	416 395 230
66,27	3,53	416 395 231

69,44	3,53	416 395 232
72,62	3,53	416 395 233
75,79	3,53	416 395 234
78,97	3,53	416 395 235
82,14	3,53	416 395 236
85,32	3,53	416 395 237
88,49	3,53	416 395 238
91,67	3,53	416 395 239
94,84	3,53	416 395 240
98,02	3,53	416 395 241
101,19	3,53	416 395 242
104,37	3,53	416 395 243
107,54	3,53	416 395 244
110,72	3,53	416 395 245
120,24	3,53	416 395 248
123,42	3,53	416 395 249
126,59	3,53	416 395 250
129,77	3,53	416 395 251
132,94	3,53	416 395 252
136,12	3,53	416 395 253
142,47	3,53	416 395 255
148,82	3,53	416 395 257
151,99	3,53	416 395 258
171,04	3,53	416 395 261
183,74	3,53	416 395 263
190,09	3,53	416 395 264
196,44	3,53	416 395 265
202,79	3,53	416 395 266
209,14	3,53	416 395 267
215,49	3,53	416 395 268
253,59	3,53	416 395 274
291,69	3,53	416 395 277

Innen-Ø mm Inner-Ø mm	Schnur-Ø mm Cord-Ø mm	Art.-Nr.
15,24	5,33	416 397 312
23,16	5,33	416 397 317
24,77	5,33	416 397 318
27,94	5,33	416 397 320
34,29	5,33	416 397 324
37,47	5,33	416 397 325
40,64	5,33	416 397 326
43,82	5,33	416 397 327
46,99	5,33	416 397 328
50,17	5,33	416 397 329
53,34	5,33	416 397 330
56,52	5,33	416 397 331

O-Ringe - zöllig

O-rings - inch



75 Shore

Werkstoff: FKM

Farbe: grün

Temperatur: -20° C bis + 200° C

75 Shore

material: FKM

colour: green

working temperature: -20° C to +200° C

Innen-Ø mm Inner-Ø mm	Schnur-Ø mm Cord-Ø mm	Art.-Nr.
59,69	5,33	416 397 332
62,87	5,33	416 397 333
66,04	5,33	416 397 334
69,22	5,33	416 397 335
72,39	5,33	416 397 336
75,57	5,33	416 397 337
78,74	5,33	416 397 338
81,92	5,33	416 397 339
85,09	5,33	416 397 340
88,27	5,33	416 397 341
91,44	5,33	416 397 342
94,62	5,33	416 397 343
97,79	5,33	416 397 344
100,97	5,33	416 397 345
104,14	5,33	416 397 346
107,32	5,33	416 397 347
110,9	5,33	416 397 348
113,67	5,33	416 397 349
116,84	5,33	416 397 350
126,37	5,33	416 397 353
129,54	5,33	416 397 354
139,07	5,33	416 397 357
145,42	5,33	416 397 359
148,59	5,33	416 397 360
151,77	5,33	416 397 361
158,12	5,33	416 397 362
164,47	5,33	416 397 363
170,82	5,33	416 397 364
177,17	5,33	416 397 365
183,52	5,33	416 397 366
196,22	5,33	416 397 368
202,57	5,33	416 397 369
215,27	5,33	416 397 371
234,32	5,33	416 397 374
247,02	5,33	416 397 376
266,07	5,33	416 397 378
278,77	5,33	416 397 379
304,17	5,33	416 397 381
354,97	5,33	416 397 383
380,37	5,33	416 397 384
405,26	5,33	416 397 385
456,06	5,33	416 397 387
506,81	5,33	416 397 389
633,48	5,33	416 397 394

Innen-Ø mm Inner-Ø mm	Schnur-Ø mm Cord-Ø mm	Art.-Nr.
113,67	6,99	416 399 425
116,84	6,99	416 399 426
120,02	6,99	416 399 427
123,19	6,99	416 399 428
126,37	6,99	416 399 429
132,72	6,99	416 399 431
135,89	6,99	416 399 432
142,24	6,99	416 399 434
145,42	6,99	416 399 435
148,59	6,99	416 399 436
151,77	6,99	416 399 437
158,12	6,99	416 399 438
164,47	6,99	416 399 439
170,82	6,99	416 399 440
183,52	6,99	416 399 442
189,87	6,99	416 399 443
196,22	6,99	416 399 444
202,57	6,99	416 399 445
215,27	6,99	416 399 446
227,97	6,99	416 399 447
240,67	6,99	416 399 448
253,37	6,99	416 399 449
266,07	6,99	416 399 450
278,77	6,99	416 399 451
291,47	6,99	416 399 452
316,87	6,99	416 399 454
342,27	6,99	416 399 456
417,96	6,99	416 399 462
443,30	6,99	416 399 464
468,76	6,99	416 399 466
506,86	6,99	416 399 469
557,66	6,99	416 399 471
582,68	6,99	416 399 472
633,48	6,99	416 399 474

O-Ringe - metrisch

O-rings - metrical

70 Shore

Werkstoff: NBR-Acrylnitril-Butadien-Kautschuk (Perbunan ®)

Farbe: schwarz

Temperatur: -30° C bis +100° C (kurzzeitig +120° C)

70 Shore

material: NBR-Acrylnitril-Butadien-Rubber (Perbunan ®)

colour: black

working temperature: -30° C to +100° C (temporary +120° C)



Innen-Ø mm Inner-Ø mm	Schnur-Ø mm Cord-Ø mm	Art.-Nr.
1	1,0	416 110 001
2	1,0	416 110 002
3	1,0	416 110 003
4	1,0	416 110 004
5	1,0	416 110 005
6	1,0	416 110 006
7	1,0	416 110 007
8	1,0	416 110 008
9	1,0	416 110 009
10	1,0	416 110 010
11	1,0	416 110 011
12	1,0	416 110 012
13	1,0	416 110 013
14	1,0	416 110 014
15	1,0	416 110 015
16	1,0	416 110 016
17	1,0	416 110 017
18	1,0	416 110 018
19	1,0	416 110 019
20	1,0	416 110 020
21	1,0	416 110 021
22	1,0	416 110 022
23	1,0	416 110 023
24	1,0	416 110 024
25	1,0	416 110 025
26	1,0	416 110 026
27	1,0	416 110 027
28	1,0	416 110 028
29	1,0	416 110 029
30	1,0	416 110 030
32	1,0	416 110 032
33	1,0	416 110 033
34	1,0	416 110 034
35	1,0	416 110 035
36	1,0	416 110 036
37	1,0	416 110 037
38	1,0	416 110 038
39	1,0	416 110 039
40	1,0	416 110 040
Innen-Ø mm Inner-Ø mm	Schnur-Ø mm Cord-Ø mm	Art.-Nr.
2	1,5	416 115 002
3	1,5	416 115 003
4	1,5	416 115 004

5	1,5	416 115 005
6	1,5	416 115 006
7	1,5	416 115 007
8	1,5	416 115 008
9	1,5	416 115 009
10	1,5	416 115 010
11	1,5	416 115 011
12	1,5	416 115 012
13	1,5	416 115 013
14	1,5	416 115 014
15	1,5	416 115 015
16	1,5	416 115 016
17	1,5	416 115 017
18	1,5	416 115 018
19	1,5	416 115 019
20	1,5	416 115 020
21	1,5	416 115 021
22	1,5	416 115 022
23	1,5	416 115 023
24	1,5	416 115 024
25	1,5	416 115 025
26	1,5	416 115 026
27	1,5	416 115 027
28	1,5	416 115 028
29	1,5	416 115 029
30	1,5	416 115 030
31	1,5	416 115 031
32	1,5	416 115 032
33	1,5	416 115 033
34	1,5	416 115 034
35	1,5	416 115 035
36	1,5	416 115 036
37	1,5	416 115 037
38	1,5	416 115 038
39	1,5	416 115 039
40	1,5	416 115 040
41	1,5	416 115 041
42	1,5	416 115 042
43	1,5	416 115 043
44	1,5	416 115 044
45	1,5	416 115 045
46	1,5	416 115 046
47	1,5	416 115 047
48	1,5	416 115 048
49	1,5	416 115 049
50	1,5	416 115 050
51	1,5	416 115 051

52	1,5	416 115 052
53	1,5	416 115 053
54	1,5	416 115 054
55	1,5	416 115 055
56	1,5	416 115 056
57	1,5	416 115 057
58	1,5	416 115 058
59	1,5	416 115 059
60	1,5	416 115 060
61	1,5	416 115 061
62	1,5	416 115 062
63	1,5	416 115 063
64	1,5	416 115 064
65	1,5	416 115 065
66	1,5	416 115 066
67	1,5	416 115 067
68	1,5	416 115 068
69	1,5	416 115 069
70	1,5	416 115 070
71	1,5	416 115 071
72	1,5	416 115 072
73	1,5	416 115 073
74	1,5	416 115 074
75	1,5	416 115 075
76	1,5	416 115 076
77	1,5	416 115 077
78	1,5	416 115 078
79	1,5	416 115 079
80	1,5	416 115 080
81	1,5	416 115 081
82	1,5	416 115 082
83	1,5	416 115 083
84	1,5	416 115 084
85	1,5	416 115 085
86	1,5	416 115 086
87	1,5	416 115 087
88	1,5	416 115 088
89	1,5	416 115 089
90	1,5	416 115 090
91	1,5	416 115 091
92	1,5	416 115 092
93	1,5	416 115 093
94	1,5	416 115 094
95	1,5	416 115 095

O-Ringe - metrisch

O-rings - metrical



70 Shore

Werkstoff: NBR-Acrylnitril-Butadien-Kautschuk (Perbunan ®)

Farbe: schwarz

Temperatur: -30° C bis +100° C (kurzzeitig +120° C)

70 Shore

material: NBR-Acrylnitril-Butadien-Rubber (Perbunan ®)

colour: black

working temperature: -30° C to +100° C (temporary +120° C)

Innen-Ø mm Inner-Ø mm	Schnur-Ø mm Cord-Ø mm	Art.-Nr.
96	1,5	416 115 096
97	1,5	416 115 097
98	1,5	416 115 098
99	1,5	416 115 099
100	1,5	416 115 100
105	1,5	416 115 105
110	1,5	416 115 110
112	1,5	416 115 112
113	1,5	416 115 113
116	1,5	416 115 116
125	1,5	416 115 125
130	1,5	416 115 130
132	1,5	416 115 132
134	1,5	416 115 134
135	1,5	416 115 135
140	1,5	416 115 140
145	1,5	416 115 145
Innen-Ø mm Inner-Ø mm	Schnur-Ø mm Cord-Ø mm	Art.-Nr.
1	2,0	416 120 001
3	2,0	416 120 003
4	2,0	416 120 004
5	2,0	416 120 005
6	2,0	416 120 006
7	2,0	416 120 007
8	2,0	416 120 008
9	2,0	416 120 009
10	2,0	416 120 010
11	2,0	416 120 011
12	2,0	416 120 012
13	2,0	416 120 013
14	2,0	416 120 014
15	2,0	416 120 015
16	2,0	416 120 016
17	2,0	416 120 017
18	2,0	416 120 018
19	2,0	416 120 019
20	2,0	416 120 020
21	2,0	416 120 021
22	2,0	416 120 022
23	2,0	416 120 023

24	2,0	416 120 024
25	2,0	416 120 025
26	2,0	416 120 026
27	2,0	416 120 027
28	2,0	416 120 028
29	2,0	416 120 029
30	2,0	416 120 030
31	2,0	416 120 031
32	2,0	416 120 032
33	2,0	416 120 033
34	2,0	416 120 034
35	2,0	416 120 035
36	2,0	416 120 036
37	2,0	416 120 037
38	2,0	416 120 038
39	2,0	416 120 039
40	2,0	416 120 040
41	2,0	416 120 041
42	2,0	416 120 042
43	2,0	416 120 043
44	2,0	416 120 044
45	2,0	416 120 045
46	2,0	416 120 046
47	2,0	416 120 047
48	2,0	416 120 048
49	2,0	416 120 049
50	2,0	416 120 050
51	2,0	416 120 051
52	2,0	416 120 052
53	2,0	416 120 053
54	2,0	416 120 054
55	2,0	416 120 055
56	2,0	416 120 056
57	2,0	416 120 057
58	2,0	416 120 058
59	2,0	416 120 059
60	2,0	416 120 060
61	2,0	416 120 061
62	2,0	416 120 062
63	2,0	416 120 063
64	2,0	416 120 064
65	2,0	416 120 065
66	2,0	416 120 066
67	2,0	416 120 067

68	2,0	416 120 068
69	2,0	416 120 069
70	2,0	416 120 070
71	2,0	416 120 071
72	2,0	416 120 072
73	2,0	416 120 073
74	2,0	416 120 074
75	2,0	416 120 075
76	2,0	416 120 076
77	2,0	416 120 077
78	2,0	416 120 078
79	2,0	416 120 079
80	2,0	416 120 080
81	2,0	416 120 081
82	2,0	416 120 082
83	2,0	416 120 083
84	2,0	416 120 084
85	2,0	416 120 085
86	2,0	416 120 086
87	2,0	416 120 087
88	2,0	416 120 088
89	2,0	416 120 089
90	2,0	416 120 090
91	2,0	416 120 091
92	2,0	416 120 092
93	2,0	416 120 093
94	2,0	416 120 094
95	2,0	416 120 095
96	2,0	416 120 096
97	2,0	416 120 097
98	2,0	416 120 098
99	2,0	416 120 099
100	2,0	416 120 100
102	2,0	416 120 102
103	2,0	416 120 103
105	2,0	416 120 105
106	2,0	416 120 106
107	2,0	416 120 107
109	2,0	416 120 109
110	2,0	416 120 110
112	2,0	416 120 112

O-Ringe - metrisch

O-rings - metrical



70 Shore

Werkstoff: NBR-Acrylnitril-Butadien-Kautschuk (Perbunan ®)

Farbe: schwarz

Temperatur: -30° C bis +100° C (kurzzeitig +120° C)

70 Shore

material: NBR-Acrylnitril-Butadien-Rubber (Perbunan ®)

colour: black

working temperature: -30° C to +100° C (temporary +120° C)

Innen-Ø mm Inner-Ø mm	Schnur-Ø mm Cord-Ø mm	Art.-Nr.
114	2,0	416 120 114
115	2,0	416 120 115
116	2,0	416 120 116
118	2,0	416 120 118
119	2,0	416 120 119
120	2,0	416 120 120
122	2,0	416 120 122
123	2,0	416 120 123
125	2,0	416 120 125
126	2,0	416 120 126
128	2,0	416 120 128
130	2,0	416 120 130
132	2,0	416 120 132
133	2,0	416 120 133
135	2,0	416 120 135
140	2,0	416 120 140
143	2,0	416 120 143
146	2,0	416 120 146
148	2,0	416 120 148
150	2,0	416 120 150
Innen-Ø mm Inner-Ø mm	Schnur-Ø mm Cord-Ø mm	Art.-Nr.
2	2,5	416 125 002
4	2,5	416 125 004
5	2,5	416 125 005
6	2,5	416 125 006
7	2,5	416 125 007
8	2,5	416 125 008
9	2,5	416 125 009
10	2,5	416 125 010
11	2,5	416 125 011
12	2,5	416 125 012
13	2,5	416 125 013
14	2,5	416 125 014
15	2,5	416 125 015
16	2,5	416 125 016
17	2,5	416 125 017
18	2,5	416 125 018
19	2,5	416 125 019
20	2,5	416 125 020
21	2,5	416 125 021

Innen-Ø mm Inner-Ø mm	Schnur-Ø mm Cord-Ø mm	Art.-Nr.
22	2,5	416 125 022
23	2,5	416 125 023
24	2,5	416 125 024
25	2,5	416 125 025
26	2,5	416 125 026
27	2,5	416 125 027
28	2,5	416 125 028
29	2,5	416 125 029
30	2,5	416 125 030
31	2,5	416 125 031
32	2,5	416 125 032
33	2,5	416 125 033
34	2,5	416 125 034
35	2,5	416 125 035
36	2,5	416 125 036
37	2,5	416 125 037
38	2,5	416 125 038
39	2,5	416 125 039
40	2,5	416 125 040
41	2,5	416 125 041
42	2,5	416 125 042
43	2,5	416 125 043
44	2,5	416 125 044
45	2,5	416 125 045
46	2,5	416 125 046
47	2,5	416 125 047
48	2,5	416 125 048
49	2,5	416 125 049
50	2,5	416 125 050
51	2,5	416 125 051
52	2,5	416 125 052
53	2,5	416 125 053
54	2,5	416 125 054
55	2,5	416 125 055
56	2,5	416 125 056
57	2,5	416 125 057
58	2,5	416 125 058
59	2,5	416 125 059
60	2,5	416 125 060
61	2,5	416 125 061
62	2,5	416 125 062

63	2,5	416 125 063
64	2,5	416 125 064
65	2,5	416 125 065
66	2,5	416 125 066
67	2,5	416 125 067
68	2,5	416 125 068
69	2,5	416 125 069
70	2,5	416 125 070
71	2,5	416 125 071
72	2,5	416 125 072
73	2,5	416 125 073
74	2,5	416 125 074
75	2,5	416 125 075
76	2,5	416 125 076
77	2,5	416 125 077
78	2,5	416 125 078
79	2,5	416 125 079
80	2,5	416 125 080
81	2,5	416 125 081
82	2,5	416 125 082
83	2,5	416 125 083
84	2,5	416 125 084
85	2,5	416 125 085
86	2,5	416 125 086
87	2,5	416 125 087
88	2,5	416 125 088
89	2,5	416 125 089
90	2,5	416 125 090
91	2,5	416 125 091
92	2,5	416 125 092
93	2,5	416 125 093
94	2,5	416 125 094
95	2,5	416 125 095
96	2,5	416 125 096
97	2,5	416 125 097
98	2,5	416 125 098
99	2,5	416 125 099
100	2,5	416 125 100
101	2,5	416 125 101
102	2,5	416 125 102
103	2,5	416 125 103
104	2,5	416 125 104
105	2,5	416 125 105
106	2,5	416 125 106

O-Ringe - metrisch

O-rings - metrical



70 Shore

Werkstoff: NBR-Acrylnitril-Butadien-Kautschuk (Perbunan ®)

Farbe: schwarz

Temperatur: -30° C bis +100° C (kurzzeitig +120° C)

70 Shore

material: NBR-Acrylnitril-Butadien-Rubber (Perbunan ®)

colour: black

working temperature: -30° C to +100° C (temporary +120° C)

Innen-Ø mm Inner-Ø mm	Schnur-Ø mm Cord-Ø mm	Art.-Nr.
107	2,5	416 125 107
108	2,5	416 125 108
109	2,5	416 125 109
110	2,5	416 125 110
111	2,5	416 125 111
112	2,5	416 125 112
113	2,5	416 125 113
114	2,5	416 125 114
115	2,5	416 125 115
116	2,5	416 125 116
117	2,5	416 125 117
118	2,5	416 125 118
119	2,5	416 125 119
120	2,5	416 125 120
121	2,5	416 125 121
122	2,5	416 125 122
123	2,5	416 125 123
124	2,5	416 125 124
125	2,5	416 125 125
126	2,5	416 125 126
127	2,5	416 125 127
128	2,5	416 125 128
129	2,5	416 125 129
130	2,5	416 125 130
131	2,5	416 125 131
132	2,5	416 125 132
133	2,5	416 125 133
134	2,5	416 125 134
135	2,5	416 125 135
136	2,5	416 125 136
137	2,5	416 125 137
138	2,5	416 125 138
139	2,5	416 125 139
140	2,5	416 125 140
141	2,5	416 125 141
142	2,5	416 125 142
143	2,5	416 125 143
144	2,5	416 125 144
145	2,5	416 125 145

Innen-Ø mm Inner-Ø mm	Schnur-Ø mm Cord-Ø mm	Art.-Nr.
146	2,5	416 125 146
147	2,5	416 125 147
148	2,5	416 125 148
149	2,5	416 125 149
150	2,5	416 125 150
3	3,0	416 130 003
4	3,0	416 130 004
5	3,0	416 130 005
6	3,0	416 130 006
7	3,0	416 130 007
8	3,0	416 130 008
9	3,0	416 130 009
10	3,0	416 130 010
11	3,0	416 130 011
12	3,0	416 130 012
13	3,0	416 130 013
14	3,0	416 130 014
15	3,0	416 130 015
16	3,0	416 130 016
17	3,0	416 130 017
18	3,0	416 130 018
19	3,0	416 130 019
20	3,0	416 130 020
21	3,0	416 130 021
22	3,0	416 130 022
23	3,0	416 130 023
24	3,0	416 130 024
25	3,0	416 130 025
26	3,0	416 130 026
27	3,0	416 130 027
28	3,0	416 130 028
29	3,0	416 130 029
30	3,0	416 130 030
31	3,0	416 130 031
32	3,0	416 130 032
33	3,0	416 130 033
34	3,0	416 130 034
35	3,0	416 130 035
36	3,0	416 130 036
37	3,0	416 130 037
38	3,0	416 130 038
39	3,0	416 130 039

40	3,0	416 130 040
41	3,0	416 130 041
42	3,0	416 130 042
43	3,0	416 130 043
44	3,0	416 130 044
45	3,0	416 130 045
46	3,0	416 130 046
47	3,0	416 130 047
48	3,0	416 130 048
49	3,0	416 130 049
50	3,0	416 130 050
51	3,0	416 130 051
52	3,0	416 130 052
53	3,0	416 130 053
54	3,0	416 130 054
55	3,0	416 130 055
56	3,0	416 130 056
57	3,0	416 130 057
58	3,0	416 130 058
59	3,0	416 130 059
60	3,0	416 130 060
61	3,0	416 130 061
62	3,0	416 130 062
63	3,0	416 130 063
64	3,0	416 130 064
65	3,0	416 130 065
66	3,0	416 130 066
67	3,0	416 130 067
68	3,0	416 130 068
69	3,0	416 130 069
70	3,0	416 130 070
71	3,0	416 130 071
72	3,0	416 130 072
73	3,0	416 130 073
74	3,0	416 130 074
75	3,0	416 130 075
76	3,0	416 130 076
77	3,0	416 130 077
78	3,0	416 130 078
79	3,0	416 130 079
80	3,0	416 130 080
81	3,0	416 130 081

O-Ringe - metrisch

O-rings - metrical

70 Shore

Werkstoff: NBR-Acrylnitril-Butadien-Kautschuk (Perbunan ®)

Farbe: schwarz

Temperatur: -30° C bis +100° C (kurzzeitig +120° C)

70 Shore

material: NBR-Acrylnitril-Butadien-Rubber (Perbunan ®)

colour: black

working temperature: -30° C to +100° C (temporary +120° C)



Innen-Ø mm Inner-Ø mm	Schnur-Ø mm Cord-Ø mm	Art.-Nr.
82	3,0	416 130 082
83	3,0	416 130 083
84	3,0	416 130 084
85	3,0	416 130 085
86	3,0	416 130 086
87	3,0	416 130 087
88	3,0	416 130 088
89	3,0	416 130 089
90	3,0	416 130 090
91	3,0	416 130 091
92	3,0	416 130 092
93	3,0	416 130 093
94	3,0	416 130 094
95	3,0	416 130 095
96	3,0	416 130 096
97	3,0	416 130 097
98	3,0	416 130 098
99	3,0	416 130 099
100	3,0	416 130 100
101	3,0	416 130 101
102	3,0	416 130 102
103	3,0	416 130 103
104	3,0	416 130 104
105	3,0	416 130 105
106	3,0	416 130 106
107	3,0	416 130 107
108	3,0	416 130 108
109	3,0	416 130 109
110	3,0	416 130 110
111	3,0	416 130 111
112	3,0	416 130 112
113	3,0	416 130 113
114	3,0	416 130 114
115	3,0	416 130 115
116	3,0	416 130 116
117	3,0	416 130 117
118	3,0	416 130 118
119	3,0	416 130 119
120	3,0	416 130 120

121	3,0	416 130 121
122	3,0	416 130 122
123	3,0	416 130 123
124	3,0	416 130 124
125	3,0	416 130 125
126	3,0	416 130 126
127	3,0	416 130 127
128	3,0	416 130 128
129	3,0	416 130 129
130	3,0	416 130 130
131	3,0	416 130 131
132	3,0	416 130 132
133	3,0	416 130 133
134	3,0	416 130 134
135	3,0	416 130 135
136	3,0	416 130 136
137	3,0	416 130 137
138	3,0	416 130 138
139	3,0	416 130 139
140	3,0	416 130 140
141	3,0	416 130 141
142	3,0	416 130 142
143	3,0	416 130 143
144	3,0	416 130 144
145	3,0	416 130 145
146	3,0	416 130 146
147	3,0	416 130 147
148	3,0	416 130 148
149	3,0	416 130 149
150	3,0	416 130 150

Innen-Ø mm Inner-Ø mm	Schnur-Ø mm Cord-Ø mm	Art.-Nr.
5	3,5	416 135 005
6	3,5	416 135 006
7	3,5	416 135 007
8	3,5	416 135 008
9	3,5	416 135 009
10	3,5	416 135 010
11	3,5	416 135 011
12	3,5	416 135 012
13	3,5	416 135 013
14	3,5	416 135 014

15	3,5	416 135 015
16	3,5	416 135 016
17	3,5	416 135 017
18	3,5	416 135 018
19	3,5	416 135 019
20	3,5	416 135 020
21	3,5	416 135 021
22	3,5	416 135 022
23	3,5	416 135 023
24	3,5	416 135 024
25	3,5	416 135 025
26	3,5	416 135 026
27	3,5	416 135 027
28	3,5	416 135 028
29	3,5	416 135 029
30	3,5	416 135 030
31	3,5	416 135 031
32	3,5	416 135 032
33	3,5	416 135 033
34	3,5	416 135 034
35	3,5	416 135 035
36	3,5	416 135 036
37	3,5	416 135 037
38	3,5	416 135 038
39	3,5	416 135 039
40	3,5	416 135 040
41	3,5	416 135 041
42	3,5	416 135 042
43	3,5	416 135 043
44	3,5	416 135 044
45	3,5	416 135 045
46	3,5	416 135 046
47	3,5	416 135 047
48	3,5	416 135 048
49	3,5	416 135 049
50	3,5	416 135 050
51	3,5	416 135 051
52	3,5	416 135 052
53	3,5	416 135 053
54	3,5	416 135 054
55	3,5	416 135 055
56	3,5	416 135 056
57	3,5	416 135 057
58	3,5	416 135 058

O-Ringe - metrisch

O-rings - metrical



70 Shore

Werkstoff: NBR-Acrylnitril-Butadien-Kautschuk (Perbunan ®)

Farbe: schwarz

Temperatur: -30° C bis +100° C (kurzzeitig +120° C)

70 Shore

material: NBR-Acrylnitril-Butadien-Rubber (Perbunan ®)

colour: black

working temperature: -30° C to +100° C (temporary +120° C)

Innen-Ø mm Inner-Ø mm	Schnur-Ø mm Cord-Ø mm	Art.-Nr.
59	3,5	416 135 059
60	3,5	416 135 060
61	3,5	416 135 061
62	3,5	416 135 062
63	3,5	416 135 063
64	3,5	416 135 064
65	3,5	416 135 065
66	3,5	416 135 066
67	3,5	416 135 067
68	3,5	416 135 068
69	3,5	416 135 069
70	3,5	416 135 070
71	3,5	416 135 071
72	3,5	416 135 072
73	3,5	416 135 073
74	3,5	416 135 074
75	3,5	416 135 075
76	3,5	416 135 076
77	3,5	416 135 077
78	3,5	416 135 078
79	3,5	416 135 079
80	3,5	416 135 080
81	3,5	416 135 081
82	3,5	416 135 082
83	3,5	416 135 083
84	3,5	416 135 084
85	3,5	416 135 085
86	3,5	416 135 086
87	3,5	416 135 087
88	3,5	416 135 088
89	3,5	416 135 089
90	3,5	416 135 090
91	3,5	416 135 091
92	3,5	416 135 092
93	3,5	416 135 093
94	3,5	416 135 094
95	3,5	416 135 095
96	3,5	416 135 096
97	3,5	416 135 097

98	3,5	416 135 098
99	3,5	416 135 099
100	3,5	416 135 100
101	3,5	416 135 101
102	3,5	416 135 102
103	3,5	416 135 103
104	3,5	416 135 104
105	3,5	416 135 105
106	3,5	416 135 106
107	3,5	416 135 107
108	3,5	416 135 108
109	3,5	416 135 109
110	3,5	416 135 110
111	3,5	416 135 111
112	3,5	416 135 112
113	3,5	416 135 113
114	3,5	416 135 114
115	3,5	416 135 115
116	3,5	416 135 116
117	3,5	416 135 117
118	3,5	416 135 118
119	3,5	416 135 119
120	3,5	416 135 120
121	3,5	416 135 121
122	3,5	416 135 122
123	3,5	416 135 123
124	3,5	416 135 124
125	3,5	416 135 125
126	3,5	416 135 126
127	3,5	416 135 127
128	3,5	416 135 128
129	3,5	416 135 129
130	3,5	416 135 130
131	3,5	416 135 131
132	3,5	416 135 132
133	3,5	416 135 133
134	3,5	416 135 134
135	3,5	416 135 135
136	3,5	416 135 136
137	3,5	416 135 137
138	3,5	416 135 138
139	3,5	416 135 139
140	3,5	416 135 140

141	3,5	416 135 141
142	3,5	416 135 142
143	3,5	416 135 143
144	3,5	416 135 144
145	3,5	416 135 145
146	3,5	416 135 146
147	3,5	416 135 147
148	3,5	416 135 148
149	3,5	416 135 149
150	3,5	416 135 150

Innen-Ø mm Inner-Ø mm	Schnur-Ø mm Cord-Ø mm	Art.-Nr.
4	4,0	416 140 004
5	4,0	416 140 005
6	4,0	416 140 006
7	4,0	416 140 007
8	4,0	416 140 008
9	4,0	416 140 009
10	4,0	416 140 010
11	4,0	416 140 011
12	4,0	416 140 012
13	4,0	416 140 013
14	4,0	416 140 014
15	4,0	416 140 015
16	4,0	416 140 016
17	4,0	416 140 017
18	4,0	416 140 018
19	4,0	416 140 019
20	4,0	416 140 020
21	4,0	416 140 021
22	4,0	416 140 022
23	4,0	416 140 023
24	4,0	416 140 024
25	4,0	416 140 025
26	4,0	416 140 026
27	4,0	416 140 027
28	4,0	416 140 028
29	4,0	416 140 029
30	4,0	416 140 030
31	4,0	416 140 031
32	4,0	416 140 032
33	4,0	416 140 033
34	4,0	416 140 034
35	4,0	416 140 035
36	4,0	416 140 036

O-Ringe - metrisch

O-rings - metrical

70 Shore

Werkstoff: NBR-Acrylnitril-Butadien-Kautschuk (Perbunan ®)

Farbe: schwarz

Temperatur: -30° C bis +100° C (kurzzeitig +120° C)

70 Shore

material: NBR-Acrylnitril-Butadien-Rubber (Perbunan ®)

colour: black

working temperature: -30° C to +100° C (temporary +120° C)



Innen-Ø mm Inner-Ø mm	Schnur-Ø mm Cord-Ø mm	Art.-Nr.
37	4,0	416 140 037
38	4,0	416 140 038
39	4,0	416 140 039
40	4,0	416 140 040
41	4,0	416 140 041
42	4,0	416 140 042
43	4,0	416 140 043
44	4,0	416 140 044
45	4,0	416 140 045
46	4,0	416 140 046
47	4,0	416 140 047
48	4,0	416 140 048
49	4,0	416 140 049
50	4,0	416 140 050
51	4,0	416 140 051
52	4,0	416 140 052
53	4,0	416 140 053
54	4,0	416 140 054
55	4,0	416 140 055
56	4,0	416 140 056
57	4,0	416 140 057
58	4,0	416 140 058
59	4,0	416 140 059
60	4,0	416 140 060
61	4,0	416 140 061
62	4,0	416 140 062
63	4,0	416 140 063
64	4,0	416 140 064
65	4,0	416 140 065
66	4,0	416 140 066
67	4,0	416 140 067
68	4,0	416 140 068
69	4,0	416 140 069
70	4,0	416 140 070
71	4,0	416 140 071
72	4,0	416 140 072
73	4,0	416 140 073
74	4,0	416 140 074
75	4,0	416 140 075
76	4,0	416 140 076

77	4,0	416 140 077
78	4,0	416 140 078
79	4,0	416 140 079
80	4,0	416 140 080
81	4,0	416 140 081
82	4,0	416 140 082
83	4,0	416 140 083
84	4,0	416 140 084
85	4,0	416 140 085
86	4,0	416 140 086
87	4,0	416 140 087
88	4,0	416 140 088
89	4,0	416 140 089
90	4,0	416 140 090
91	4,0	416 140 091
92	4,0	416 140 092
93	4,0	416 140 093
94	4,0	416 140 094
95	4,0	416 140 095
96	4,0	416 140 096
97	4,0	416 140 097
98	4,0	416 140 098
99	4,0	416 140 099
100	4,0	416 140 100
101	4,0	416 140 101
102	4,0	416 140 102
103	4,0	416 140 103
104	4,0	416 140 104
105	4,0	416 140 105
106	4,0	416 140 106
107	4,0	416 140 107
108	4,0	416 140 108
109	4,0	416 140 109
110	4,0	416 140 110
111	4,0	416 140 111
112	4,0	416 140 112
113	4,0	416 140 113
114	4,0	416 140 114
115	4,0	416 140 115
116	4,0	416 140 116
117	4,0	416 140 117
118	4,0	416 140 118
119	4,0	416 140 119

120	4,0	416 140 120
121	4,0	416 140 121
122	4,0	416 140 122
123	4,0	416 140 123
124	4,0	416 140 124
125	4,0	416 140 125
126	4,0	416 140 126
127	4,0	416 140 127
128	4,0	416 140 128
129	4,0	416 140 129
130	4,0	416 140 130
131	4,0	416 140 131
132	4,0	416 140 132
133	4,0	416 140 133
134	4,0	416 140 134
135	4,0	416 140 135
136	4,0	416 140 136
137	4,0	416 140 137
138	4,0	416 140 138
139	4,0	416 140 139
140	4,0	416 140 140
141	4,0	416 140 141
142	4,0	416 140 142
143	4,0	416 140 143
144	4,0	416 140 144
145	4,0	416 140 145
146	4,0	416 140 146
147	4,0	416 140 147
148	4,0	416 140 148
149	4,0	416 140 149
150	4,0	416 140 150

Innen-Ø mm Inner-Ø mm	Schnur-Ø mm Cord-Ø mm	Art.-Nr.
10	5,0	416 150 010
11	5,0	416 150 011
12	5,0	416 150 012
13	5,0	416 150 013
14	5,0	416 150 014
15	5,0	416 150 015
16	5,0	416 150 016
17	5,0	416 150 017
18	5,0	416 150 018
19	5,0	416 150 019

O-Ringe - metrisch

O-rings - metrical



70 Shore

Werkstoff: NBR-Acrylnitril-Butadien-Kautschuk (Perbunan ®)

Farbe: schwarz

Temperatur: -30° C bis +100° C (kurzzeitig +120° C)

70 Shore

material: NBR-Acrylnitril-Butadien-Rubber (Perbunan ®)

colour: black

working temperature: -30° C to +100° C (temporary +120° C)

Innen-Ø mm Inner-Ø mm	Schnur-Ø mm Cord-Ø mm	Art.-Nr.
10	5,0	416 150 010
11	5,0	416 150 011
12	5,0	416 150 012
13	5,0	416 150 013
14	5,0	416 150 014
15	5,0	416 150 015
16	5,0	416 150 016
17	5,0	416 150 017
18	5,0	416 150 018
19	5,0	416 150 019
20	5,0	416 150 020
21	5,0	416 150 021
22	5,0	416 150 022
23	5,0	416 150 023
24	5,0	416 150 024
25	5,0	416 150 025
26	5,0	416 150 026
27	5,0	416 150 027
28	5,0	416 150 028
29	5,0	416 150 029
30	5,0	416 150 030
31	5,0	416 150 031
32	5,0	416 150 032
33	5,0	416 150 033
34	5,0	416 150 034
35	5,0	416 150 035
36	5,0	416 150 036
37	5,0	416 150 037
38	5,0	416 150 038
39	5,0	416 150 039
40	5,0	416 150 040
41	5,0	416 150 041
42	5,0	416 150 042
43	5,0	416 150 043
44	5,0	416 150 044
45	5,0	416 150 045
46	5,0	416 150 046
47	5,0	416 150 047
48	5,0	416 150 048
49	5,0	416 150 049
50	5,0	416 150 050
51	5,0	416 150 051

52	5,0	416 150 052
53	5,0	416 150 053
54	5,0	416 150 054
55	5,0	416 150 055
56	5,0	416 150 056
57	5,0	416 150 057
58	5,0	416 150 058
59	5,0	416 150 059
60	5,0	416 150 060
61	5,0	416 150 061
62	5,0	416 150 062
63	5,0	416 150 063
64	5,0	416 150 064
65	5,0	416 150 065
66	5,0	416 150 066
67	5,0	416 150 067
68	5,0	416 150 068
69	5,0	416 150 069
70	5,0	416 150 070
71	5,0	416 150 071
72	5,0	416 150 072
73	5,0	416 150 073
74	5,0	416 150 074
75	5,0	416 150 075
76	5,0	416 150 076
77	5,0	416 150 077
78	5,0	416 150 078
79	5,0	416 150 079
80	5,0	416 150 080
81	5,0	416 150 081
82	5,0	416 150 082
83	5,0	416 150 083
84	5,0	416 150 084
85	5,0	416 150 085
86	5,0	416 150 086
87	5,0	416 150 087
88	5,0	416 150 088
89	5,0	416 150 089
90	5,0	416 150 090
91	5,0	416 150 091
92	5,0	416 150 092
93	5,0	416 150 093

94	5,0	416 150 094
95	5,0	416 150 095
96	5,0	416 150 096
97	5,0	416 150 097
98	5,0	416 150 098
99	5,0	416 150 099
100	5,0	416 150 100
101	5,0	416 150 101
102	5,0	416 150 102
103	5,0	416 150 103
104	5,0	416 150 104
105	5,0	416 150 105
106	5,0	416 150 106
107	5,0	416 150 107
108	5,0	416 150 108
109	5,0	416 150 109
110	5,0	416 150 110
111	5,0	416 150 111
112	5,0	416 150 112
113	5,0	416 150 113
114	5,0	416 150 114
115	5,0	416 150 115
116	5,0	416 150 116
117	5,0	416 150 117
118	5,0	416 150 118
119	5,0	416 150 119
120	5,0	416 150 120
121	5,0	416 150 121
122	5,0	416 150 122
123	5,0	416 150 123
124	5,0	416 150 124
125	5,0	416 150 125
126	5,0	416 150 126
127	5,0	416 150 127
128	5,0	416 150 128
129	5,0	416 150 129
130	5,0	416 150 130
131	5,0	416 150 131
132	5,0	416 150 132
133	5,0	416 150 133
134	5,0	416 150 134
135	5,0	416 150 135
136	5,0	416 150 136

O-Ringe - metrisch

O-rings - metrical



70 Shore

Werkstoff: NBR-Acrylnitril-Butadien-Kautschuk (Perbunan ®)

Farbe: schwarz

Temperatur: -30° C bis +100° C (kurzzeitig +120° C)

70 Shore

material: NBR-Acrylnitril-Butadien-Rubber (Perbunan ®)

colour: black

working temperature: -30° C to +100° C (temporary +120° C)

Innen-Ø mm Inner-Ø mm	Schnur-Ø mm Cord-Ø mm	Art.-Nr.
137	5,0	416 150 137
138	5,0	416 150 138
139	5,0	416 150 139
140	5,0	416 150 140
141	5,0	416 150 141
142	5,0	416 150 142
143	5,0	416 150 143
144	5,0	416 150 144
145	5,0	416 150 145
146	5,0	416 150 146
147	5,0	416 150 147
148	5,0	416 150 148
149	5,0	416 150 149
150	5,0	416 150 150
Innen-Ø mm Inner-Ø mm	Schnur-Ø mm Cord-Ø mm	Art.-Nr.
20	6,0	416 160 020
21	6,0	416 160 021
22	6,0	416 160 022
23	6,0	416 160 023
24	6,0	416 160 024
25	6,0	416 160 025
26	6,0	416 160 026
27	6,0	416 160 027
28	6,0	416 160 028
29	6,0	416 160 029
30	6,0	416 160 030
31	6,0	416 160 031
32	6,0	416 160 032
33	6,0	416 160 033
34	6,0	416 160 034
35	6,0	416 160 035
36	6,0	416 160 036
37	6,0	416 160 037
38	6,0	416 160 038
39	6,0	416 160 039
40	6,0	416 160 040
41	6,0	416 160 041
42	6,0	416 160 042
43	6,0	416 160 043
44	6,0	416 160 044

45	6,0	416 160 045
46	6,0	416 160 046
47	6,0	416 160 047
48	6,0	416 160 048
49	6,0	416 160 049
50	6,0	416 160 050
51	6,0	416 160 051
52	6,0	416 160 052
53	6,0	416 160 053
54	6,0	416 160 054
55	6,0	416 160 055
56	6,0	416 160 056
57	6,0	416 160 057
58	6,0	416 160 058
59	6,0	416 160 059
60	6,0	416 160 060
61	6,0	416 160 061
62	6,0	416 160 062
63	6,0	416 160 063
64	6,0	416 160 064
65	6,0	416 160 065
66	6,0	416 160 066
67	6,0	416 160 067
68	6,0	416 160 068
69	6,0	416 160 069
70	6,0	416 160 070
72	6,0	416 160 072
73	6,0	416 160 073
74	6,0	416 160 074
75	6,0	416 160 075
76	6,0	416 160 076
78	6,0	416 160 078
79	6,0	416 160 079
80	6,0	416 160 080
81	6,0	416 160 081
84	6,0	416 160 084
85	6,0	416 160 085
86	6,0	416 160 086
88	6,0	416 160 088
90	6,0	416 160 090
92	6,0	416 160 092
93	6,0	416 160 093
95	6,0	416 160 095

96	6,0	416 160 096
98	6,0	416 160 098
99	6,0	416 160 099
100	6,0	416 160 100
101	6,0	416 160 101
103	6,0	416 160 103
104	6,0	416 160 104
105	6,0	416 160 105
106	6,0	416 160 106
108	6,0	416 160 108
110	6,0	416 160 110
111	6,0	416 160 111
112	6,0	416 160 112
114	6,0	416 160 114
115	6,0	416 160 115
116	6,0	416 160 116
118	6,0	416 160 118
120	6,0	416 160 120
122	6,0	416 160 122
123	6,0	416 160 123
124	6,0	416 160 124
125	6,0	416 160 125
128	6,0	416 160 128
130	6,0	416 160 130
132	6,0	416 160 132
134	6,0	416 160 134
135	6,0	416 160 135
136	6,0	416 160 136
138	6,0	416 160 138
139	6,0	416 160 139
140	6,0	416 160 140
142	6,0	416 160 142
145	6,0	416 160 145
146	6,0	416 160 146
148	6,0	416 160 148
149	6,0	416 160 149
150	6,0	416 160 150

O-Ringe - zöllig

O-rings - inch



70 Shore

Werkstoff: NBR-Acrylnitril-Butadien-Kautschuk (Perbunan ®)

Farbe: schwarz

Temperatur: -30° C bis +100° C (kurzzeitig +120° C)

70 Shore

material: NBR-Acrylnitril-Butadien-Rubber (Perbunan ®)

colour: black

working temperature: -30° C to +100° C (temporary +120° C)

Innen-Ø mm Inner-Ø mm	Schnur-Ø mm Cord-Ø mm	Art.-Nr.
1,78	1,78	416 191 004
2,57	1,78	416 191 005
2,90	1,78	416 191 006
3,68	1,78	416 191 007
4,47	1,78	416 191 008
5,28	1,78	416 191 009
6,07	1,78	416 191 010
7,65	1,78	416 191 011
9,25	1,78	416 191 012
10,82	1,78	416 191 013
12,42	1,78	416 191 014
14,00	1,78	416 191 015
15,60	1,78	416 191 016
17,17	1,78	416 191 017
18,77	1,78	416 191 018
20,35	1,78	416 191 019
21,95	1,78	416 191 020
23,52	1,78	416 191 021
25,12	1,78	416 191 022
26,70	1,78	416 191 023
28,30	1,78	416 191 024
29,87	1,78	416 191 025
31,47	1,78	416 191 026
33,05	1,78	416 191 027
34,65	1,78	416 191 028
37,82	1,78	416 191 029
41,00	1,78	416 191 030
44,17	1,78	416 191 031
47,35	1,78	416 191 032
50,52	1,78	416 191 033
53,70	1,78	416 191 034
56,87	1,78	416 191 035
60,05	1,78	416 191 036
63,22	1,78	416 191 037
66,40	1,78	416 191 038
69,57	1,78	416 191 039
72,75	1,78	416 191 040
75,92	1,78	416 191 041
82,27	1,78	416 191 042
88,62	1,78	416 191 043
94,97	1,78	416 191 044

101,32	1,78	416 191 045
107,67	1,78	416 191 046
114,02	1,78	416 191 047
120,37	1,78	416 191 048
126,72	1,78	416 191 049
133,07	1,78	416 191 050
Innen-Ø mm Inner-Ø mm	Schnur-Ø mm Cord-Ø mm	Art.-Nr.
1,24	2,62	416 193 102
2,06	2,62	416 193 103
2,84	2,62	416 193 104
3,63	2,62	416 193 105
4,42	2,62	416 193 106
5,23	2,62	416 193 107
6,02	2,62	416 193 108
7,59	2,62	416 193 109
9,19	2,62	416 193 110
10,77	2,62	416 193 111
12,37	2,62	416 193 112
13,94	2,62	416 193 113
15,54	2,62	416 193 114
17,12	2,62	416 193 115
18,72	2,62	416 193 116
20,29	2,62	416 193 117
21,89	2,62	416 193 118
23,47	2,62	416 193 119
25,07	2,62	416 193 120
26,64	2,62	416 193 121
28,24	2,62	416 193 122
29,82	2,62	416 193 123
31,42	2,62	416 193 124
32,99	2,62	416 193 125
34,59	2,62	416 193 126
36,17	2,62	416 193 127
37,77	2,62	416 193 128
39,34	2,62	416 193 129
Innen-Ø mm Inner-Ø mm	Schnur-Ø mm Cord-Ø mm	Art.-Nr.
40,94	2,62	416 193 130
42,52	2,62	416 193 131
44,12	2,62	416 193 132
45,69	2,62	416 193 133
47,29	2,62	416 193 134

48,90	2,62	416 193 135
50,47	2,62	416 193 136
52,07	2,62	416 193 137
53,64	2,62	416 193 138
55,25	2,62	416 193 139
56,82	2,62	416 193 140
58,42	2,62	416 193 141
59,99	2,62	416 193 142
61,60	2,62	416 193 143
63,17	2,62	416 193 144
64,77	2,62	416 193 145
66,34	2,62	416 193 146
67,95	2,62	416 193 147
69,52	2,62	416 193 148
71,12	2,62	416 193 149
72,69	2,62	416 193 150
75,87	2,62	416 193 151
82,22	2,62	416 193 152
88,57	2,62	416 193 153
94,92	2,62	416 193 154
101,27	2,62	416 193 155
107,62	2,62	416 193 156
113,97	2,62	416 193 157
120,32	2,62	416 193 158
126,67	2,62	416 193 159
133,02	2,62	416 193 160
139,37	2,62	416 193 161
145,72	2,62	416 193 162
152,07	2,62	416 193 163
158,42	2,62	416 193 164
164,77	2,62	416 193 165
171,12	2,62	416 193 166
177,47	2,62	416 193 167
183,82	2,62	416 193 168
190,17	2,62	416 193 169
196,52	2,62	416 193 170
202,87	2,62	416 193 171
209,22	2,62	416 193 172
215,57	2,62	416 193 173
221,92	2,62	416 193 174
228,27	2,62	416 193 175
234,62	2,62	416 193 176
240,97	2,62	416 193 177
247,32	2,62	416 193 178

O-Ringe - zöllig

O-rings - inch

70 Shore

Werkstoff: NBR-Acrylnitril-Butadien-Kautschuk (Perbunan ®)

Farbe: schwarz

Temperatur: -30° C bis +100° C (kurzzeitig +120° C)

70 Shore

material: NBR-Acrylnitril-Butadien-Rubber (Perbunan ®)

colour: black

working temperature: -30° C to +100° C (temporary +120° C)



Innen-Ø mm Inner-Ø mm	Schnur-Ø mm Cord-Ø mm	Art.-Nr.
4,34	3,53	416 195 201
5,94	3,53	416 195 202
7,52	3,53	416 195 203
9,12	3,53	416 195 204
10,69	3,53	416 195 205
12,29	3,53	416 195 206
13,87	3,53	416 195 207
15,47	3,53	416 195 208
17,04	3,53	416 195 209
18,64	3,53	416 195 210
20,22	3,53	416 195 211
21,82	3,53	416 195 212
23,39	3,53	416 195 213
24,99	3,53	416 195 214
26,57	3,53	416 195 215
28,17	3,53	416 195 216
29,74	3,53	416 195 217
31,34	3,53	416 195 218
32,92	3,53	416 195 219
34,52	3,53	416 195 220
36,09	3,53	416 195 221
37,69	3,53	416 195 222
40,87	3,53	416 195 223
44,04	3,53	416 195 224
47,22	3,53	416 195 225
50,39	3,53	416 195 226
53,57	3,53	416 195 227
56,74	3,53	416 195 228
59,92	3,53	416 195 229
63,09	3,53	416 195 230
66,27	3,53	416 195 231
69,44	3,53	416 195 232
72,62	3,53	416 195 233
75,79	3,53	416 195 234
78,97	3,53	416 195 235
82,14	3,53	416 195 236
85,32	3,53	416 195 237
88,49	3,53	416 195 238
91,67	3,53	416 195 239
94,84	3,53	416 195 240
98,02	3,53	416 195 241
101,19	3,53	416 195 242
104,37	3,53	416 195 243

107,54	3,53	416 195 244
110,72	3,53	416 195 245
113,89	3,53	416 195 246
117,07	3,53	416 195 247
120,24	3,53	416 195 248
123,42	3,53	416 195 249
126,59	3,53	416 195 250
129,77	3,53	416 195 251
132,94	3,53	416 195 252
136,12	3,53	416 195 253
139,29	3,53	416 195 254
142,47	3,53	416 195 255
145,64	3,53	416 195 256
148,82	3,53	416 195 257
151,99	3,53	416 195 258
158,35	3,53	416 195 259
164,69	3,53	416 195 260
171,04	3,53	416 195 261
177,39	3,53	416 195 262
183,74	3,53	416 195 263
190,09	3,53	416 195 264
196,44	3,53	416 195 265
202,79	3,53	416 195 266
209,14	3,53	416 195 267
215,49	3,53	416 195 268
221,84	3,53	416 195 269
228,19	3,53	416 195 270
234,54	3,53	416 195 271
240,89	3,53	416 195 272
247,23	3,53	416 195 273
253,59	3,53	416 195 274
266,29	3,53	416 195 275
278,99	3,53	416 195 276
291,69	3,53	416 195 277
304,39	3,53	416 195 278
329,79	3,53	416 195 279
355,19	3,53	416 195 280
380,59	3,53	416 195 281
405,26	3,53	416 195 282
430,66	3,53	416 195 283
456,06	3,53	416 195 284

Innen-Ø mm Inner-Ø mm	Schnur-Ø mm Cord-Ø mm	Art.-Nr.
10,46	5,33	416 197 309
12,07	5,33	416 197 310
13,64	5,33	416 197 311
15,24	5,33	416 197 312
16,81	5,33	416 197 313
18,42	5,33	416 197 314
19,99	5,33	416 197 315
21,59	5,33	416 197 316
23,16	5,33	416 197 317
24,77	5,33	416 197 318
26,34	5,33	416 197 319
27,94	5,33	416 197 320
29,51	5,33	416 197 321
31,12	5,33	416 197 322
32,69	5,33	416 197 323
34,29	5,33	416 197 324
37,47	5,33	416 197 325
40,64	5,33	416 197 326
43,82	5,33	416 197 327
46,99	5,33	416 197 328
50,17	5,33	416 197 329
53,34	5,33	416 197 330
56,52	5,33	416 197 331
59,69	5,33	416 197 332
62,87	5,33	416 197 333
66,04	5,33	416 197 334
69,22	5,33	416 197 335
72,39	5,33	416 197 336
75,57	5,33	416 197 337
78,74	5,33	416 197 338
81,92	5,33	416 197 339
85,09	5,33	416 197 340
88,27	5,33	416 197 341
91,44	5,33	416 197 342
94,62	5,33	416 197 343
97,79	5,33	416 197 344
100,97	5,33	416 197 345
104,14	5,33	416 197 346
107,32	5,33	416 197 347
110,49	5,33	416 197 348
113,67	5,33	416 197 349
116,84	5,33	416 197 350
120,02	5,33	416 197 351

O-Ringe - zöllig

O-rings - inch



70 Shore

Werkstoff: NBR-Acrylnitril-Butadien-Kautschuk (Perbunan ®)

Farbe: schwarz

Temperatur: -30° C bis +100° C (kurzzeitig +120° C)

70 Shore

material: NBR-Acrylnitril-Butadien-Rubber (Perbunan ®)

colour: black

working temperature: -30° C to +100° C (temporary +120° C)

Innen-Ø mm Inner-Ø mm	Schnur-Ø mm Cord-Ø mm	Art.-Nr.
94,62	5,33	416 197 343
97,79	5,33	416 197 344
100,97	5,33	416 197 345
104,14	5,33	416 197 346
107,32	5,33	416 197 347
110,49	5,33	416 197 348
113,67	5,33	416 197 349
116,84	5,33	416 197 350
120,02	5,33	416 197 351
123,19	5,33	416 197 352
126,37	5,33	416 197 353
129,54	5,33	416 197 354
132,72	5,33	416 197 355
135,89	5,33	416 197 356
139,07	5,33	416 197 357
142,24	5,33	416 197 358
145,42	5,33	416 197 359
148,59	5,33	416 197 360
151,77	5,33	416 197 361
158,12	5,33	416 197 362
164,47	5,33	416 197 363
170,82	5,33	416 197 364
177,17	5,33	416 197 365
183,52	5,33	416 197 366
189,87	5,33	416 197 367
196,22	5,33	416 197 368
202,57	5,33	416 197 369
208,92	5,33	416 197 370
215,27	5,33	416 197 371
221,62	5,33	416 197 372
227,97	5,33	416 197 373
234,32	5,33	416 197 374
240,67	5,33	416 197 375
247,02	5,33	416 197 376
253,37	5,33	416 197 377
266,07	5,33	416 197 378
278,77	5,33	416 197 379
291,47	5,33	416 197 380

304,17	5,33	416 197 381
329,57	5,33	416 197 382
354,97	5,33	416 197 383
380,37	5,33	416 197 384
405,26	5,33	416 197 385
430,66	5,33	416 197 386
456,06	5,33	416 197 387
481,46	5,33	416 197 388
506,81	5,33	416 197 389
532,21	5,33	416 197 390
557,61	5,33	416 197 391
582,68	5,33	416 197 392
608,08	5,33	416 197 393
633,48	5,33	416 197 394
658,88	5,33	416 197 395

Innen-Ø mm Inner-Ø mm	Schnur-Ø mm Cord-Ø mm	Art.-Nr.
113,67	6,99	416 199 425
116,84	6,99	416 199 426
120,02	6,99	416 199 427
123,19	6,99	416 199 428
126,37	6,99	416 199 429
129,54	6,99	416 199 430
132,72	6,99	416 199 431
135,89	6,99	416 199 432
139,07	6,99	416 199 433
142,24	6,99	416 199 434
145,42	6,99	416 199 435
148,59	6,99	416 199 436
151,77	6,99	416 199 437
158,12	6,99	416 199 438
164,47	6,99	416 199 439
170,82	6,99	416 199 440
177,17	6,99	416 199 441
183,52	6,99	416 199 442
189,87	6,99	416 199 443
196,22	6,99	416 199 444
202,57	6,99	416 199 445
215,27	6,99	416 199 446
227,97	6,99	416 199 447
240,67	6,99	416 199 448
253,37	6,99	416 199 449
266,07	6,99	416 199 450

278,77	6,99	416 199 451
291,47	6,99	416 199 452
304,17	6,99	416 199 453
316,87	6,99	416 199 454
329,57	6,99	416 199 455
342,27	6,99	416 199 456
354,97	6,99	416 199 457
367,67	6,99	416 199 458
380,37	6,99	416 199 459
393,07	6,99	416 199 460
405,26	6,99	416 199 461
417,96	6,99	416 199 462
430,66	6,99	416 199 463
443,36	6,99	416 199 464
456,06	6,99	416 199 465
468,76	6,99	416 199 466
481,48	6,99	416 199 467
494,16	6,99	416 199 468

O-Ringe - metrisch

O-rings - metrical

90 Shore

Werkstoff: NBR-Acrylnitril-Butadien-Kautschuk (Perbunan ®)

Farbe: schwarz

Temperatur: -30° C bis +100° C (kurzzeitig +120° C)

90 Shore

material: NBR-Acrylnitril-Butadien-Rubber (Perbunan ®)

colour: black

working temperature: -30° C to +100° C (temporary +120° C)



Innen-Ø mm Inner-Ø mm	Schnur-Ø mm Cord-Ø mm	Art.-Nr.
1	1,0	416 210 001
2	1,0	416 210 002
3	1,0	416 210 003
4	1,0	416 210 004
5	1,0	416 210 005
6	1,0	416 210 006
7	1,0	416 210 007
8	1,0	416 210 008
9	1,0	416 210 009
10	1,0	416 210 010
11	1,0	416 210 011
12	1,0	416 210 012
13	1,0	416 210 013
14	1,0	416 210 014
15	1,0	416 210 015
16	1,0	416 210 016
17	1,0	416 210 017
18	1,0	416 210 018
19	1,0	416 210 019
20	1,0	416 210 020
21	1,0	416 210 021
22	1,0	416 210 022
23	1,0	416 210 023
24	1,0	416 210 024
25	1,0	416 210 025
26	1,0	416 210 026
28	1,0	416 210 028
29	1,0	416 210 029
30	1,0	416 210 030
31	1,0	416 210 031
32	1,0	416 210 032
34	1,0	416 210 034
35	1,0	416 210 035
36	1,0	416 210 036
38	1,0	416 210 037
38	1,0	416 210 038
39	1,0	416 210 039
40	1,0	416 210 040
Innen-Ø mm Inner-Ø mm	Schnur-Ø mm Cord-Ø mm	Art.-Nr.
2	1,5	416 215 002
3	1,5	416 215 003

4	1,5	416 215 004
5	1,5	416 215 005
6	1,5	416 215 006
7	1,5	416 215 007
8	1,5	416 215 008
9	1,5	416 215 009
10	1,5	416 215 010
11	1,5	416 215 011
12	1,5	416 215 012
13	1,5	416 215 013
14	1,5	416 215 014
15	1,5	416 215 015
16	1,5	416 215 016
17	1,5	416 215 017
18	1,5	416 215 018
19	1,5	416 215 019
20	1,5	416 215 020
21	1,5	416 215 021
22	1,5	416 215 022
23	1,5	416 215 023
24	1,5	416 215 024
25	1,5	416 215 025
26	1,5	416 215 026
27	1,5	416 215 027
28	1,5	416 215 028
29	1,5	416 215 029
30	1,5	416 215 030
31	1,5	416 215 031
32	1,5	416 215 032
33	1,5	416 215 033
34	1,5	416 215 034
35	1,5	416 215 035
36	1,5	416 215 036
37	1,5	416 215 037
38	1,5	416 215 038
39	1,5	416 215 039
40	1,5	416 215 040
42	1,5	416 215 042
44	1,5	416 215 044
46	1,5	416 215 046
47	1,5	416 215 047
48	1,5	416 215 048
49	1,5	416 215 049
50	1,5	416 215 050
52	1,5	416 215 052

53	1,5	416 215 053
54	1,5	416 215 054
55	1,5	416 215 055
57	1,5	416 215 057
59	1,5	416 215 059
60	1,5	416 215 060
61	1,5	416 215 061
62	1,5	416 215 062
63	1,5	416 215 063
64	1,5	416 215 064
65	1,5	416 215 065
67	1,5	416 215 067
69	1,5	416 215 069
70	1,5	416 215 070
71	1,5	416 215 071
72	1,5	416 215 072
73	1,5	416 215 073
74	1,5	416 215 074
75	1,5	416 215 075
76	1,5	416 215 076
77	1,5	416 215 077
78	1,5	416 215 078
79	1,5	416 215 079
80	1,5	416 215 080
81	1,5	416 215 081
84	1,5	416 215 084
85	1,5	416 215 085
88	1,5	416 215 088
90	1,5	416 215 090
91	1,5	416 215 091
92	1,5	416 215 092
93	1,5	416 215 093
94	1,5	416 215 094
95	1,5	416 215 095
96	1,5	416 215 096
97	1,5	416 215 097
98	1,5	416 215 098
99	1,5	416 215 099
100	1,5	416 215 100
103	1,5	416 215 103
105	1,5	416 215 105
110	1,5	416 215 110

O-Ringe - metrisch

O-rings - metrical



90 Shore

Werkstoff: NBR-Acrylnitril-Butadien-Kautschuk (Perbunan ®)

Farbe: schwarz

Temperatur: -30° C bis +100° C (kurzzeitig +120° C)

90 Shore

material: NBR-Acrylnitril-Butadien-Rubber (Perbunan ®)

colour: black

working temperature: -30° C to +100° C (temporary +120° C)

Innen-Ø mm Inner-Ø mm	Schnur-Ø mm Cord-Ø mm	Art.-Nr.
94	1,5	416 215 094
95	1,5	416 215 095
96	1,5	416 215 096
97	1,5	416 215 097
98	1,5	416 215 098
99	1,5	416 215 099
100	1,5	416 215 100
103	1,5	416 215 103
105	1,5	416 215 105
110	1,5	416 215 110
112	1,5	416 215 112
113	1,5	416 215 113
116	1,5	416 215 116
125	1,5	416 215 125
130	1,5	416 215 130
132	1,5	416 215 132
134	1,5	416 215 134
135	1,5	416 215 135
140	1,5	416 215 140
145	1,5	416 215 145
Innen-Ø mm Inner-Ø mm	Schnur-Ø mm Cord-Ø mm	Art.-Nr.
1	2,0	416 220 001
2	2,0	416 220 002
3	2,0	416 220 003
4	2,0	416 220 004
5	2,0	416 220 005
6	2,0	416 220 006
7	2,0	416 220 007
8	2,0	416 220 008
9	2,0	416 220 009
10	2,0	416 220 010
11	2,0	416 220 011
12	2,0	416 220 012
13	2,0	416 220 013
14	2,0	416 220 014
15	2,0	416 220 015
16	2,0	416 220 016
17	2,0	416 220 017

18	2,0	416 220 018
19	2,0	416 220 019
20	2,0	416 220 020
21	2,0	416 220 021
22	2,0	416 220 022
23	2,0	416 220 023
24	2,0	416 220 024
25	2,0	416 220 025
26	2,0	416 220 026
27	2,0	416 220 027
28	2,0	416 220 028
29	2,0	416 220 029
30	2,0	416 220 030
31	2,0	416 220 031
32	2,0	416 220 032
33	2,0	416 220 033
34	2,0	416 220 034
35	2,0	416 220 035
36	2,0	416 220 036
37	2,0	416 220 037
38	2,0	416 220 038
39	2,0	416 220 039
40	2,0	416 220 040
41	2,0	416 220 041
42	2,0	416 220 042
43	2,0	416 220 043
44	2,0	416 220 044
45	2,0	416 220 045
46	2,0	416 220 046
47	2,0	416 220 047
48	2,0	416 220 048
49	2,0	416 220 049
50	2,0	416 220 050
51	2,0	416 220 051
52	2,0	416 220 052
53	2,0	416 220 053
54	2,0	416 220 054
55	2,0	416 220 055
56	2,0	416 220 056
57	2,0	416 220 057
58	2,0	416 220 058
60	2,0	416 220 060
61	2,0	416 220 061

62	2,0	416 220 062
63	2,0	416 220 063
64	2,0	416 220 064
65	2,0	416 220 065
66	2,0	416 220 066
67	2,0	416 220 067
68	2,0	416 220 068
69	2,0	416 220 069
70	2,0	416 220 070
71	2,0	416 220 071
72	2,0	416 220 072
73	2,0	416 220 073
74	2,0	416 220 074
75	2,0	416 220 075
76	2,0	416 220 076
78	2,0	416 220 078
79	2,0	416 220 079
80	2,0	416 220 080
81	2,0	416 220 081
82	2,0	416 220 082
83	2,0	416 220 083
84	2,0	416 220 084
85	2,0	416 220 085
86	2,0	416 220 086
87	2,0	416 220 087
88	2,0	416 220 088
89	2,0	416 220 089
90	2,0	416 220 090
91	2,0	416 220 091
92	2,0	416 220 092
93	2,0	416 220 093
94	2,0	416 220 094
95	2,0	416 220 095
96	2,0	416 220 096
98	2,0	416 220 098
100	2,0	416 220 100
101	2,0	416 220 101
102	2,0	416 220 102
103	2,0	416 220 103
104	2,0	416 220 104
105	2,0	416 220 105

O-Ringe - metrisch

O-rings - metrical

90 Shore

Werkstoff: NBR-Acrylnitril-Butadien-Kautschuk (Perbunan ®)

Farbe: schwarz

Temperatur: -30° C bis +100° C (kurzzeitig +120° C)

90 Shore

material: NBR-Acrylnitril-Butadien-Rubber (Perbunan ®)

colour: black

working temperature: -30° C to +100° C (temporary +120° C)



Innen-Ø mm Inner-Ø mm	Schnur-Ø mm Cord-Ø mm	Art.-Nr.
106	2,0	416 220 106
107	2,0	416 220 107
109	2,0	416 220 109
110	2,0	416 220 110
112	2,0	416 220 112
113	2,0	416 220 113
114	2,0	416 220 114
115	2,0	416 220 115
116	2,0	416 220 116
118	2,0	416 220 118
119	2,0	416 220 119
120	2,0	416 220 120
122	2,0	416 220 122
123	2,0	416 220 123
124	2,0	416 220 124
125	2,0	416 220 125
126	2,0	416 220 126
128	2,0	416 220 128
130	2,0	416 220 130
132	2,0	416 220 132
133	2,0	416 220 133
135	2,0	416 220 135
140	2,0	416 220 140
143	2,0	416 220 143
146	2,0	416 220 146
148	2,0	416 220 148
150	2,0	416 220 150
Innen-Ø mm Inner-Ø mm	Schnur-Ø mm Cord-Ø mm	Art.-Nr.
8	2,5	416 225 008
9	2,5	416 225 009
10	2,5	416 225 010
11	2,5	416 225 011
12	2,5	416 225 012
13	2,5	416 225 013
14	2,5	416 225 014
15	2,5	416 225 015
16	2,5	416 225 016

17	2,5	416 225 017
18	2,5	416 225 018
19	2,5	416 225 019
20	2,5	416 225 020
21	2,5	416 225 021
22	2,5	416 225 022
23	2,5	416 225 023
24	2,5	416 225 024
25	2,5	416 225 025
26	2,5	416 225 026
27	2,5	416 225 027
28	2,5	416 225 028
29	2,5	416 225 029
30	2,5	416 225 030
31	2,5	416 225 031
32	2,5	416 225 032
33	2,5	416 225 033
34	2,5	416 225 034
35	2,5	416 225 035
36	2,5	416 225 036
37	2,5	416 225 037
38	2,5	416 225 038
39	2,5	416 225 039
40	2,5	416 225 040
41	2,5	416 225 041
42	2,5	416 225 042
43	2,5	416 225 043
44	2,5	416 225 044
45	2,5	416 225 045
46	2,5	416 225 046
47	2,5	416 225 047
48	2,5	416 225 048
49	2,5	416 225 049
50	2,5	416 225 050
51	2,5	416 225 051
52	2,5	416 225 052
53	2,5	416 225 053
54	2,5	416 225 054
55	2,5	416 225 055
56	2,5	416 225 056
57	2,5	416 225 057
58	2,5	416 225 058
59	2,5	416 225 059
60	2,5	416 225 060

62	2,5	416 225 062
63	2,5	416 225 063
65	2,5	416 225 065
66	2,5	416 225 066
67	2,5	416 225 067
68	2,5	416 225 068
70	2,5	416 225 070
72	2,5	416 225 072
73	2,5	416 225 073
74	2,5	416 225 074
75	2,5	416 225 075
76	2,5	416 225 076
78	2,5	416 225 078
79	2,5	416 225 079
80	2,5	416 225 080
82	2,5	416 225 082
83	2,5	416 225 083
85	2,5	416 225 085
86	2,5	416 225 086
87	2,5	416 225 087
88	2,5	416 225 088
90	2,5	416 225 090
92	2,5	416 225 092
93	2,5	416 225 093
94	2,5	416 225 094
95	2,5	416 225 095
98	2,5	416 225 098
100	2,5	416 225 100
101	2,5	416 225 101
102	2,5	416 225 102
103	2,5	416 225 103
104	2,5	416 225 104
105	2,5	416 225 105
106	2,5	416 225 106
107	2,5	416 225 107
108	2,5	416 225 108
109	2,5	416 225 109
110	2,5	416 225 110
112	2,5	416 225 112
113	2,5	416 225 113
115	2,5	416 225 115
117	2,5	416 225 117

O-Ringe - metrisch

O-rings - metrical



90 Shore

Werkstoff: NBR-Acrylnitril-Butadien-Kautschuk (Perbunan ®)

Farbe: schwarz

Temperatur: -30° C bis +100° C (kurzzeitig +120° C)

90 Shore

material: NBR-Acrylnitril-Butadien-Rubber (Perbunan ®)

colour: black

working temperature: -30° C to +100° C (temporary +120° C)

Innen-Ø mm Inner-Ø mm	Schnur-Ø mm Cord-Ø mm	Art.-Nr.
118	2,5	416 225 118
120	2,5	416 225 120
121	2,5	416 225 121
123	2,5	416 225 123
124	2,5	416 225 124
125	2,5	416 225 125
127	2,5	416 225 127
128	2,5	416 225 128
130	2,5	416 225 130
131	2,5	416 225 131
132	2,5	416 225 132
133	2,5	416 225 133
134	2,5	416 225 134
135	2,5	416 225 135
137	2,5	416 225 137
138	2,5	416 225 138
139	2,5	416 225 139
140	2,5	416 225 140
144	2,5	416 225 144
145	2,5	416 225 145
146	2,5	416 225 146
150	2,5	416 225 150

Innen-Ø mm Inner-Ø mm	Schnur-Ø mm Cord-Ø mm	Art.-Nr.
2	3,0	416 230 002
3	3,0	416 230 003
4	3,0	416 230 004
5	3,0	416 230 005
6	3,0	416 230 006
7	3,0	416 230 007
8	3,0	416 230 008
9	3,0	416 230 009
10	3,0	416 230 010
11	3,0	416 230 011
12	3,0	416 230 012
13	3,0	416 230 013
14	3,0	416 230 014
15	3,0	416 230 015
16	3,0	416 230 016

17	3,0	416 230 017
18	3,0	416 230 018
19	3,0	416 230 019
20	3,0	416 230 020
21	3,0	416 230 021
22	3,0	416 230 022
23	3,0	416 230 023
24	3,0	416 230 024
25	3,0	416 230 025
26	3,0	416 230 026
27	3,0	416 230 027
28	3,0	416 230 028
29	3,0	416 230 029
30	3,0	416 230 030
31	3,0	416 230 031
32	3,0	416 230 032
33	3,0	416 230 033
34	3,0	416 230 034
35	3,0	416 230 035
36	3,0	416 230 036
37	3,0	416 230 037
38	3,0	416 230 038
39	3,0	416 230 039
40	3,0	416 230 040
41	3,0	416 230 041
42	3,0	416 230 042
43	3,0	416 230 043
44	3,0	416 230 044
45	3,0	416 230 045
46	3,0	416 230 046
47	3,0	416 230 047
48	3,0	416 230 048
49	3,0	416 230 049
50	3,0	416 230 050
51	3,0	416 230 051
52	3,0	416 230 052
53	3,0	416 230 053
54	3,0	416 230 054
55	3,0	416 230 055
56	3,0	416 230 056
57	3,0	416 230 057
58	3,0	416 230 058
59	3,0	416 230 059
60	3,0	416 230 060

61	3,0	416 230 061
62	3,0	416 230 062
63	3,0	416 230 063
64	3,0	416 230 064
65	3,0	416 230 065
66	3,0	416 230 066
67	3,0	416 230 067
68	3,0	416 230 068
69	3,0	416 230 069
70	3,0	416 230 070
71	3,0	416 230 071
72	3,0	416 230 072
73	3,0	416 230 073
74	3,0	416 230 074
75	3,0	416 230 075
76	3,0	416 230 076
77	3,0	416 230 077
78	3,0	416 230 078
79	3,0	416 230 079
80	3,0	416 230 080
81	3,0	416 230 081
82	3,0	416 230 082
83	3,0	416 230 083
84	3,0	416 230 084
85	3,0	416 230 085
86	3,0	416 230 086
87	3,0	416 230 087
88	3,0	416 230 088
89	3,0	416 230 089
90	3,0	416 230 090
91	3,0	416 230 091
92	3,0	416 230 092
93	3,0	416 230 093
94	3,0	416 230 094
95	3,0	416 230 095
96	3,0	416 230 096
97	3,0	416 230 097
98	3,0	416 230 098
99	3,0	416 230 099
100	3,0	416 230 100
101	3,0	416 230 101
102	3,0	416 230 102
103	3,0	416 230 103

O-Ringe - metrisch

O-rings - metrical



90 Shore

Werkstoff: NBR-Acrylnitril-Butadien-Kautschuk (Perbunan ®)

Farbe: schwarz

Temperatur: -30° C bis +100° C (kurzzeitig +120° C)

90 Shore

material: NBR-Acrylnitril-Butadien-Rubber (Perbunan ®)

colour: black

working temperature: -30° C to +100° C (temporary +120° C)

Innen-Ø mm Inner-Ø mm	Schnur-Ø mm Cord-Ø mm	Art.-Nr.
104	3,0	416 230 104
105	3,0	416 230 105
106	3,0	416 230 106
107	3,0	416 230 107
108	3,0	416 230 108
109	3,0	416 230 109
110	3,0	416 230 110
111	3,0	416 230 111
112	3,0	416 230 112
114	3,0	416 230 114
115	3,0	416 230 115
116	3,0	416 230 116
117	3,0	416 230 117
118	3,0	416 230 118
119	3,0	416 230 119
120	3,0	416 230 120
122	3,0	416 230 122
123	3,0	416 230 123
124	3,0	416 230 124
125	3,0	416 230 125
127	3,0	416 230 127
128	3,0	416 230 128
129	3,0	416 230 129
130	3,0	416 230 130
132	3,0	416 230 132
134	3,0	416 230 134
135	3,0	416 230 135
136	3,0	416 230 136
137	3,0	416 230 137
138	3,0	416 230 138
139	3,0	416 230 139
140	3,0	416 230 140
141	3,0	416 230 141
142	3,0	416 230 142
143	3,0	416 230 143
144	3,0	416 230 144
145	3,0	416 230 145
146	3,0	416 230 146
147	3,0	416 230 147

148	3,0	416 230 148
149	3,0	416 230 149
150	3,0	416 230 150
Innen-Ø mm Inner-Ø mm	Schnur-Ø mm Cord-Ø mm	Art.-Nr.
5	3,5	416 235 005
6	3,5	416 235 006
7	3,5	416 235 007
8	3,5	416 235 008
9	3,5	416 235 009
10	3,5	416 235 010
11	3,5	416 235 011
12	3,5	416 235 012
13	3,5	416 235 013
14	3,5	416 235 014
15	3,5	416 235 015
16	3,5	416 235 016
17	3,5	416 235 017
18	3,5	416 235 018
19	3,5	416 235 019
20	3,5	416 235 020
21	3,5	416 235 021
22	3,5	416 235 022
23	3,5	416 235 023
24	3,5	416 235 024
25	3,5	416 235 025
26	3,5	416 235 026
27	3,5	416 235 027
28	3,5	416 235 028
29	3,5	416 235 029
30	3,5	416 235 030
31	3,5	416 235 031
32	3,5	416 235 032
33	3,5	416 235 033
34	3,5	416 235 034
35	3,5	416 235 035
36	3,5	416 235 036
37	3,5	416 235 037
38	3,5	416 235 038
39	3,5	416 235 039
40	3,5	416 235 040
41	3,5	416 235 041
42	3,5	416 235 042
43	3,5	416 235 043

44	3,5	416 235 044
45	3,5	416 235 045
46	3,5	416 235 046
47	3,5	416 235 047
48	3,5	416 235 048
49	3,5	416 235 049
50	3,5	416 235 050
51	3,5	416 235 051
52	3,5	416 235 052
53	3,5	416 235 053
54	3,5	416 235 054
55	3,5	416 235 055
56	3,5	416 235 056
57	3,5	416 235 057
58	3,5	416 235 058
59	3,5	416 235 059
60	3,5	416 235 060
61	3,5	416 235 061
62	3,5	416 235 062
63	3,5	416 235 063
64	3,5	416 235 064
65	3,5	416 235 065
66	3,5	416 235 066
67	3,5	416 235 067
68	3,5	416 235 068
70	3,5	416 235 070
71	3,5	416 235 071
72	3,5	416 235 072
73	3,5	416 235 073
75	3,5	416 235 075
76	3,5	416 235 076
77	3,5	416 235 077
78	3,5	416 235 078
79	3,5	416 235 079
80	3,5	416 235 080
82	3,5	416 235 082
84	3,5	416 235 084
85	3,5	416 235 085
86	3,5	416 235 086
87	3,5	416 235 087
88	3,5	416 235 088
90	3,5	416 235 090
92	3,5	416 235 092

O-Ringe - metrisch

O-rings - metrical



90 Shore

Werkstoff: NBR-Acrylnitril-Butadien-Kautschuk (Perbunan ®)

Farbe: schwarz

Temperatur: -30° C bis +100° C (kurzzeitig +120° C)

90 Shore

material: NBR-Acrylnitril-Butadien-Rubber (Perbunan ®)

colour: black

working temperature: -30° C to +100° C (temporary +120° C)

Innen-Ø mm Inner-Ø mm	Schnur-Ø mm Cord-Ø mm	Art.-Nr.
93	3,5	416 235 093
95	3,5	416 235 095
97	3,5	416 235 097
98	3,5	416 235 098
100	3,5	416 235 100
101	3,5	416 235 101
102	3,5	416 235 102
103	3,5	416 235 103
104	3,5	416 235 104
105	3,5	416 235 105
107	3,5	416 235 107
108	3,5	416 235 108
109	3,5	416 235 109
110	3,5	416 235 110
111	3,5	416 235 111
112	3,5	416 235 112
113	3,5	416 235 113
114	3,5	416 235 114
115	3,5	416 235 115
117	3,5	416 235 117
120	3,5	416 235 120
122	3,5	416 235 122
123	3,5	416 235 123
125	3,5	416 235 125
126	3,5	416 235 126
127	3,5	416 235 127
130	3,5	416 235 130
131	3,5	416 235 131
133	3,5	416 235 133
135	3,5	416 235 135
136	3,5	416 235 136
137	3,5	416 235 137
138	3,5	416 235 138
139	3,5	416 235 139
140	3,5	416 235 140
142	3,5	416 235 142
143	3,5	416 235 143
144	3,5	416 235 144

144	3,5	416 235 144
145	3,5	416 235 145
146	3,5	416 235 146
148	3,5	416 235 148
149	3,5	416 235 149
150	3,5	416 235 150
Innen-Ø mm Inner-Ø mm	Schnur-Ø mm Cord-Ø mm	Art.-Nr.
4	4,0	416 240 004
5	4,0	416 240 005
6	4,0	416 240 006
7	4,0	416 240 007
8	4,0	416 240 008
9	4,0	416 240 009
10	4,0	416 240 010
11	4,0	416 240 011
12	4,0	416 240 012
13	4,0	416 240 013
14	4,0	416 240 014
15	4,0	416 240 015
16	4,0	416 240 016
17	4,0	416 240 017
18	4,0	416 240 018
19	4,0	416 240 019
20	4,0	416 240 020
21	4,0	416 240 021
22	4,0	416 240 022
23	4,0	416 240 023
24	4,0	416 240 024
25	4,0	416 240 025
26	4,0	416 240 026
27	4,0	416 240 027
28	4,0	416 240 028
29	4,0	416 240 029
30	4,0	416 240 030
31	4,0	416 240 031
32	4,0	416 240 032
33	4,0	416 240 033
34	4,0	416 240 034
35	4,0	416 240 035
36	4,0	416 240 036
37	4,0	416 240 037
38	4,0	416 240 038

39	4,0	416 240 039
40	4,0	416 240 040
41	4,0	416 240 041
42	4,0	416 240 042
43	4,0	416 240 043
44	4,0	416 240 044
45	4,0	416 240 045
46	4,0	416 240 046
47	4,0	416 240 047
48	4,0	416 240 048
49	4,0	416 240 049
50	4,0	416 240 050
51	4,0	416 240 051
52	4,0	416 240 052
53	4,0	416 240 053
54	4,0	416 240 054
55	4,0	416 240 055
56	4,0	416 240 056
57	4,0	416 240 057
58	4,0	416 240 058
59	4,0	416 240 059
60	4,0	416 240 060
61	4,0	416 240 061
62	4,0	416 240 062
63	4,0	416 240 063
64	4,0	416 240 064
65	4,0	416 240 065
66	4,0	416 240 066
67	4,0	416 240 067
68	4,0	416 240 068
69	4,0	416 240 069
70	4,0	416 240 070
71	4,0	416 240 071
72	4,0	416 240 072
73	4,0	416 240 073
74	4,0	416 240 074
75	4,0	416 240 075
76	4,0	416 240 076
77	4,0	416 240 077
78	4,0	416 240 078
80	4,0	416 240 080
82	4,0	416 240 082

O-Ringe - metrisch

O-rings - metrical

90 Shore

Werkstoff: NBR-Acrylnitril-Butadien-Kautschuk (Perbunan ®)

Farbe: schwarz

Temperatur: -30° C bis +100° C (kurzzeitig +120° C)

90 Shore

material: NBR-Acrylnitril-Butadien-Rubber (Perbunan ®)

colour: black

working temperature: -30° C to +100° C (temporary +120° C)



Innen-Ø mm Inner-Ø mm	Schnur-Ø mm Cord-Ø mm	Art.-Nr.
83	4,0	416 240 083
84	4,0	416 240 084
85	4,0	416 240 085
86	4,0	416 240 086
87	4,0	416 240 087
88	4,0	416 240 088
89	4,0	416 240 089
90	4,0	416 240 090
91	4,0	416 240 091
92	4,0	416 240 092
93	4,0	416 240 093
94	4,0	416 240 094
95	4,0	416 240 095
96	4,0	416 240 096
97	4,0	416 240 097
98	4,0	416 240 098
100	4,0	416 240 100
102	4,0	416 240 102
104	4,0	416 240 104
105	4,0	416 240 105
106	4,0	416 240 106
107	4,0	416 240 107
108	4,0	416 240 108
109	4,0	416 240 109
110	4,0	416 240 110
112	4,0	416 240 112
113	4,0	416 240 113
114	4,0	416 240 114
115	4,0	416 240 115
116	4,0	416 240 116
117	4,0	416 240 117
118	4,0	416 240 118
119	4,0	416 240 119
120	4,0	416 240 120
122	4,0	416 240 122
124	4,0	416 240 124
125	4,0	416 240 125
126	4,0	416 240 126
127	4,0	416 240 127

127	4,0	416 240 127
128	4,0	416 240 128
129	4,0	416 240 129
130	4,0	416 240 130
131	4,0	416 240 131
132	4,0	416 240 132
133	4,0	416 240 133
134	4,0	416 240 134
135	4,0	416 240 135
136	4,0	416 240 136
137	4,0	416 240 137
138	4,0	416 240 138
139	4,0	416 240 139
140	4,0	416 240 140
142	4,0	416 240 142
143	4,0	416 240 143
144	4,0	416 240 144
145	4,0	416 240 145
146	4,0	416 240 146
147	4,0	416 240 147
148	4,0	416 240 148
150	4,0	416 240 150

Innen-Ø mm Inner-Ø mm	Schnur-Ø mm Cord-Ø mm	Art.-Nr.
10	5,0	416 250 010
11	5,0	416 250 011
12	5,0	416 250 012
13	5,0	416 250 013
14	5,0	416 250 014
15	5,0	416 250 015
16	5,0	416 250 016
17	5,0	416 250 017
18	5,0	416 250 018
19	5,0	416 250 019
20	5,0	416 250 020
21	5,0	416 250 021
22	5,0	416 250 022
23	5,0	416 250 023
24	5,0	416 250 024
25	5,0	416 250 025
26	5,0	416 250 026
27	5,0	416 250 027
28	5,0	416 250 028

29	5,0	416 250 029
30	5,0	416 250 030
31	5,0	416 250 031
32	5,0	416 250 032
33	5,0	416 250 033
34	5,0	416 250 034
35	5,0	416 250 035
36	5,0	416 250 036
37	5,0	416 250 037
38	5,0	416 250 038
39	5,0	416 250 039
40	5,0	416 250 040
41	5,0	416 250 041
42	5,0	416 250 042
43	5,0	416 250 043
44	5,0	416 250 044
45	5,0	416 250 045
46	5,0	416 250 046
47	5,0	416 250 047
48	5,0	416 250 048
50	5,0	416 250 050
51	5,0	416 250 051
52	5,0	416 250 052
53	5,0	416 250 053
54	5,0	416 250 054
55	5,0	416 250 055
56	5,0	416 250 056
57	5,0	416 250 057
58	5,0	416 250 058
59	5,0	416 250 059
60	5,0	416 250 060
61	5,0	416 250 061
62	5,0	416 250 062
63	5,0	416 250 063
64	5,0	416 250 064
65	5,0	416 250 065
66	5,0	416 250 066
67	5,0	416 250 067
68	5,0	416 250 068
69	5,0	416 250 069
70	5,0	416 250 070
71	5,0	416 250 071
72	5,0	416 250 072

O-Ringe - metrisch

O-rings - metrical



90 Shore

Werkstoff: NBR-Acrylnitril-Butadien-Kautschuk (Perbunan ®)

Farbe: schwarz

Temperatur: -30° C bis +100° C (kurzzeitig +120° C)

90 Shore

material: NBR-Acrylnitril-Butadien-Rubber (Perbunan ®)

colour: black

working temperature: -30° C to +100° C (temporary +120° C)

Innen-Ø mm Inner-Ø mm	Schnur-Ø mm Cord-Ø mm	Art.-Nr.
83	5,0	416 250 083
84	5,0	416 250 084
85	5,0	416 250 085
86	5,0	416 250 086
87	5,0	416 250 087
88	5,0	416 250 088
89	5,0	416 250 089
90	5,0	416 250 090
92	5,0	416 250 092
93	5,0	416 250 093
94	5,0	416 250 094
95	5,0	416 250 095
96	5,0	416 250 096
97	5,0	416 250 097
98	5,0	416 250 098
99	5,0	416 250 099
100	5,0	416 250 100
102	5,0	416 250 102
103	5,0	416 250 103
104	5,0	416 250 104
105	5,0	416 250 105
106	5,0	416 250 106
107	5,0	416 250 107
108	5,0	416 250 108
109	5,0	416 250 109
110	5,0	416 250 110
111	5,0	416 250 111
112	5,0	416 250 112
114	5,0	416 250 114
115	5,0	416 250 115
117	5,0	416 250 117
118	5,0	416 250 118
120	5,0	416 250 120
122	5,0	416 250 122
123	5,0	416 250 123
124	5,0	416 250 124
125	5,0	416 250 125
126	5,0	416 250 126

127	5,0	416 250 127
129	5,0	416 250 129
130	5,0	416 250 130
132	5,0	416 250 132
133	5,0	416 250 133
134	5,0	416 250 134
135	5,0	416 250 135
136	5,0	416 250 136
137	5,0	416 250 137
138	5,0	416 250 138
140	5,0	416 250 140
142	5,0	416 250 142
143	5,0	416 250 143
144	5,0	416 250 144
145	5,0	416 250 145
146	5,0	416 250 146
147	5,0	416 250 147
148	5,0	416 250 148
149	5,0	416 250 149
150	5,0	416 250 150
Innen-Ø mm Inner-Ø mm	Schnur-Ø mm Cord-Ø mm	Art.-Nr.
20	6,0	416 260 020
21	6,0	416 260 021
22	6,0	416 260 022
23	6,0	416 260 023
24	6,0	416 260 024
25	6,0	416 260 025
26	6,0	416 260 026
27	6,0	416 260 027
28	6,0	416 260 028
29	6,0	416 260 029
30	6,0	416 260 030
31	6,0	416 260 031
32	6,0	416 260 032
33	6,0	416 260 033
34	6,0	416 260 034
35	6,0	416 260 035
36	6,0	416 260 036
37	6,0	416 260 037
38	6,0	416 260 038
39	6,0	416 260 039
40	6,0	416 260 040
41	6,0	416 260 041

43	6,0	416 260 043
44	6,0	416 260 044
45	6,0	416 260 045
46	6,0	416 260 046
47	6,0	416 260 047
48	6,0	416 260 048
49	6,0	416 260 049
50	6,0	416 260 050
51	6,0	416 260 051
52	6,0	416 260 052
53	6,0	416 260 053
54	6,0	416 260 054
55	6,0	416 260 055
56	6,0	416 260 056
57	6,0	416 260 057
58	6,0	416 260 058
59	6,0	416 260 059
60	6,0	416 260 060
61	6,0	416 260 061
62	6,0	416 260 062
63	6,0	416 260 063
64	6,0	416 260 064
65	6,0	416 260 065
66	6,0	416 260 066
67	6,0	416 260 067
68	6,0	416 260 068
69	6,0	416 260 069
70	6,0	416 260 070
72	6,0	416 260 072
74	6,0	416 260 074
75	6,0	416 260 075
76	6,0	416 260 076
78	6,0	416 260 078
79	6,0	416 260 079
80	6,0	416 260 080
81	6,0	416 260 081
84	6,0	416 260 084
85	6,0	416 260 085
86	6,0	416 260 086
88	6,0	416 260 088
90	6,0	416 260 090
92	6,0	416 260 092
93	6,0	416 260 093

O-Ringe - metrisch

O-rings - metrical

90 Shore

Werkstoff: NBR-Acrylnitril-Butadien-Kautschuk (Perbunan ®)

Farbe: schwarz

Temperatur: -30° C bis +100° C (kurzzeitig +120° C)

90 Shore

material: NBR-Acrylnitril-Butadien-Rubber (Perbunan ®)

colour: black

working temperature: -30° C to +100° C (temporary +120° C)



Innen-Ø mm Inner-Ø mm	Schnur-Ø mm Cord-Ø mm	Art.-Nr.
95	6,0	416 260 095
96	6,0	416 260 096
98	6,0	416 260 098
99	6,0	416 260 099
100	6,0	416 260 100
101	6,0	416 260 101
103	6,0	416 260 103
104	6,0	416 260 104
105	6,0	416 260 105
106	6,0	416 260 106
108	6,0	416 260 108
110	6,0	416 260 110
111	6,0	416 260 111
112	6,0	416 260 112
114	6,0	416 260 114
115	6,0	416 260 115
116	6,0	416 260 116
118	6,0	416 260 118
120	6,0	416 260 120
122	6,0	416 260 122
123	6,0	416 260 123
124	6,0	416 260 124
125	6,0	416 260 125
128	6,0	416 260 128
130	6,0	416 260 130
132	6,0	416 260 132
134	6,0	416 260 134
135	6,0	416 260 135
136	6,0	416 260 136
138	6,0	416 260 138
139	6,0	416 260 139
140	6,0	416 260 140
142	6,0	416 260 142
145	6,0	416 260 145
146	6,0	416 260 146
148	6,0	416 260 148
149	6,0	416 260 149
150	6,0	416 260 150

O-Ringe - zöllig

O-rings - inch



90 Shore

Werkstoff: NBR-Acrylnitril-Butadien-Kautschuk (Perbunan ®)

Farbe: schwarz

Temperatur: -30° C bis +100° C (kurzzeitig +120° C)

90 Shore

material: NBR-Acrylnitril-Butadien-Rubber (Perbunan ®)

colour: black

working temperature: -30° C to +100° C (temporary +120° C)

Innen-Ø mm Inner-Ø mm	Schnur-Ø mm Cord-Ø mm	Art.-Nr.
1,42	1,78	416 291 003
1,78	1,78	416 291 004
2,57	1,78	416 291 005
2,90	1,78	416 291 006
3,68	1,78	416 291 007
4,47	1,78	416 291 008
5,28	1,78	416 291 009
6,07	1,78	416 291 010
7,65	1,78	416 291 011
9,25	1,78	416 291 012
10,82	1,78	416 291 013
12,42	1,78	416 291 014
14,00	1,78	416 291 015
15,60	1,78	416 291 016
17,17	1,78	416 291 017
18,77	1,78	416 291 018
20,35	1,78	416 291 019
21,95	1,78	416 291 020
23,52	1,78	416 291 021
25,12	1,78	416 291 022
26,70	1,78	416 291 023
28,30	1,78	416 291 024
29,87	1,78	416 291 025
31,47	1,78	416 291 026
33,05	1,78	416 291 027
34,65	1,78	416 291 028
37,82	1,78	416 291 029
41,00	1,78	416 291 030
44,17	1,78	416 291 031
47,35	1,78	416 291 032
50,52	1,78	416 291 033
53,70	1,78	416 291 034
56,87	1,78	416 291 035
60,05	1,78	416 291 036
63,22	1,78	416 291 037
66,40	1,78	416 291 038
69,57	1,78	416 291 039
72,75	1,78	416 291 040
75,92	1,78	416 291 041
82,27	1,78	416 291 042
88,62	1,78	416 291 043

94,97	1,78	416 291 044
101,32	1,78	416 291 045
107,67	1,78	416 291 046
114,02	1,78	416 291 047
120,37	1,78	416 291 048
126,72	1,78	416 291 049
133,07	1,78	416 291 050

Innen-Ø mm Inner-Ø mm	Schnur-Ø mm Cord-Ø mm	Art.-Nr.
1,24	2,62	416 293 102
2,06	2,62	416 293 103
2,84	2,62	416 293 104
3,63	2,62	416 293 105
4,42	2,62	416 293 106
5,23	2,62	416 293 107
6,02	2,62	416 293 108
7,59	2,62	416 293 109
9,19	2,62	416 293 110
10,77	2,62	416 293 111
12,37	2,62	416 293 112
13,94	2,62	416 293 113
15,54	2,62	416 293 114
17,12	2,62	416 293 115
18,72	2,62	416 293 116
20,29	2,62	416 293 117
21,89	2,62	416 293 118
23,47	2,62	416 293 119
25,07	2,62	416 293 120
26,64	2,62	416 293 121
28,24	2,62	416 293 122
29,82	2,62	416 293 123
31,42	2,62	416 293 124
32,99	2,62	416 293 125
34,59	2,62	416 293 126
36,17	2,62	416 293 127
37,77	2,62	416 293 128
39,34	2,62	416 293 129
40,94	2,62	416 293 130
42,52	2,62	416 293 131
44,12	2,62	416 293 132
45,69	2,62	416 293 133
47,29	2,62	416 293 134
48,90	2,62	416 293 135
50,47	2,62	416 293 136

52,07	2,62	416 293 137
53,64	2,62	416 293 138
55,25	2,62	416 293 139
56,82	2,62	416 293 140
58,42	2,62	416 293 141
59,99	2,62	416 293 142
61,60	2,62	416 293 143
63,17	2,62	416 293 144
64,77	2,62	416 293 145
66,34	2,62	416 293 146
67,95	2,62	416 293 147
69,52	2,62	416 293 148
71,12	2,62	416 293 149
72,69	2,62	416 293 150
75,87	2,62	416 293 151
82,22	2,62	416 293 152
88,57	2,62	416 293 153
94,92	2,62	416 293 154
101,27	2,62	416 293 155
107,62	2,62	416 293 156
113,97	2,62	416 293 157
120,32	2,62	416 293 158
126,67	2,62	416 293 159
133,02	2,62	416 293 160
139,37	2,62	416 293 161
145,72	2,62	416 293 162
152,07	2,62	416 293 163
158,42	2,62	416 293 164
164,77	2,62	416 293 165
171,12	2,62	416 293 166
177,47	2,62	416 293 167
183,82	2,62	416 293 168
190,17	2,62	416 293 169
196,52	2,62	416 293 170
202,87	2,62	416 293 171
209,22	2,62	416 293 172
215,57	2,62	416 293 173
221,92	2,62	416 293 174
228,27	2,62	416 293 175
234,62	2,62	416 293 176
240,97	2,62	416 293 177
257,32	2,62	416 293 178

O-Ringe - zöllig

O-rings - inch

90 Shore

Werkstoff: NBR-Acrylnitril-Butadien-Kautschuk (Perbunan ®)

Farbe: schwarz

Temperatur: -30° C bis +100° C (kurzzeitig +120° C)

90 Shore

material: NBR-Acrylnitril-Butadien-Rubber (Perbunan ®)

colour: black

working temperature: -30° C to +100° C (temporary +120° C)



Innen-Ø mm Inner-Ø mm	Schnur-Ø mm Cord-Ø mm	Art.-Nr.
4,34	3,53	416 295 201
5,94	3,53	416 295 202
7,52	3,53	416 295 203
9,12	3,53	416 295 204
10,69	3,53	416 295 205
12,29	3,53	416 295 206
13,87	3,53	416 295 207
15,47	3,53	416 295 208
17,04	3,53	416 295 209
18,64	3,53	416 295 210
20,22	3,53	416 295 211
21,82	3,53	416 295 212
23,39	3,53	416 295 213
24,99	3,53	416 295 214
26,57	3,53	416 295 215
28,17	3,53	416 295 216
29,74	3,53	416 295 217
31,34	3,53	416 295 218
32,92	3,53	416 295 219
34,52	3,53	416 295 220
36,09	3,53	416 295 221
37,69	3,53	416 295 222
40,87	3,53	416 295 223
44,04	3,53	416 295 224
47,22	3,53	416 295 225
50,39	3,53	416 295 226
53,57	3,53	416 295 227
56,74	3,53	416 295 228
59,92	3,53	416 295 229
63,09	3,53	416 295 230
66,27	3,53	416 295 231
69,44	3,53	416 295 232
72,62	3,53	416 295 233
75,79	3,53	416 295 234
78,97	3,53	416 295 235
82,14	3,53	416 295 236
85,32	3,53	416 295 237
88,49	3,53	416 295 238
91,67	3,53	416 295 239
94,84	3,53	416 295 240
98,02	3,53	416 295 241
101,19	3,53	416 295 242

104,37	3,53	416 295 243
107,54	3,53	416 295 244
110,72	3,53	416 295 245
113,89	3,53	416 295 246
117,07	3,53	416 295 247
120,24	3,53	416 295 248
123,42	3,53	416 295 249
126,59	3,53	416 295 250
129,77	3,53	416 295 251
132,94	3,53	416 295 252
136,12	3,53	416 295 253
139,29	3,53	416 295 254
142,47	3,53	416 295 255
145,64	3,53	416 295 256
148,82	3,53	416 295 257
151,99	3,53	416 295 258
158,34	3,53	416 295 259
164,69	3,53	416 295 260
171,04	3,53	416 295 261
177,39	3,53	416 295 262
183,74	3,53	416 295 263
190,09	3,53	416 295 264
196,44	3,53	416 295 265
202,79	3,53	416 295 266
209,14	3,53	416 295 267
215,49	3,53	416 295 268
221,84	3,53	416 295 269
228,19	3,53	416 295 270
234,54	3,53	416 295 271
240,89	3,53	416 295 272
247,24	3,53	416 295 273
253,59	3,53	416 295 274
266,29	3,53	416 295 275
278,99	3,53	416 295 276
291,69	3,53	416 295 277
304,39	3,53	416 295 278
329,79	3,53	416 295 279
355,19	3,53	416 295 280
380,59	3,53	416 295 281
405,26	3,53	416 295 282
430,66	3,53	416 295 283
456,06	3,53	416 295 284

Innen-Ø mm Inner-Ø mm	Schnur-Ø mm Cord-Ø mm	Art.-Nr.
10,46	5,33	416 297 309
12,07	5,33	416 297 310
13,64	5,33	416 297 311
15,24	5,33	416 297 312
16,81	5,33	416 297 313
19,99	5,33	416 297 315
21,59	5,33	416 297 316
23,16	5,33	416 297 317
24,77	5,33	416 297 318
26,34	5,33	416 297 319
27,94	5,33	416 297 320
29,51	5,33	416 297 321
31,12	5,33	416 297 322
32,69	5,33	416 297 323
34,29	5,33	416 297 324
37,47	5,33	416 297 325
40,64	5,33	416 297 326
43,82	5,33	416 297 327
46,99	5,33	416 297 328
50,17	5,33	416 297 329
53,34	5,33	416 297 330
56,52	5,33	416 297 331
59,69	5,33	416 297 332
62,87	5,33	416 297 333
66,04	5,33	416 297 334
69,22	5,33	416 297 335
72,39	5,33	416 297 336
75,57	5,33	416 297 337
78,75	5,33	416 297 338
81,92	5,33	416 297 339
85,09	5,33	416 297 340
88,27	5,33	416 297 341
91,44	5,33	416 297 342
94,62	5,33	416 297 343
97,79	5,33	416 297 344
100,97	5,33	416 297 345
104,14	5,33	416 297 346
107,32	5,33	416 297 347
110,49	5,33	416 297 348
113,67	5,33	416 297 349
116,84	5,33	416 297 350
120,02	5,33	416 297 351

O-Ringe - zöllig

O-rings - inch



90 Shore

Werkstoff: NBR-Acrylnitril-Butadien-Kautschuk (Perbunan ®)

Farbe: schwarz

Temperatur: -30° C bis +100° C (kurzzeitig +120° C)

90 Shore

material: NBR-Acrylnitril-Butadien-Rubber (Perbunan ®)

colour: black

working temperature: -30° C to +100° C (temporary +120° C)

Innen-Ø mm Inner-Ø mm	Schnur-Ø mm Cord-Ø mm	Art.-Nr.
123,19	5,33	416 297 352
126,37	5,33	416 297 353
129,54	5,33	416 297 354
132,72	5,33	416 297 355
135,89	5,33	416 297 356
139,07	5,33	416 297 357
142,24	5,33	416 297 358
145,42	5,33	416 297 359
148,59	5,33	416 297 360
151,77	5,33	416 297 361
158,12	5,33	416 297 362
164,47	5,33	416 297 363
170,82	5,33	416 297 364
177,17	5,33	416 297 365
183,52	5,33	416 297 366
189,87	5,33	416 297 367
196,22	5,33	416 297 368
202,57	5,33	416 297 369
208,92	5,33	416 297 370
215,27	5,33	416 297 371
221,62	5,33	416 297 372
227,97	5,33	416 297 373
234,32	5,33	416 297 374
240,67	5,33	416 297 375
247,02	5,33	416 297 376
253,37	5,33	416 297 377
266,07	5,33	416 297 378
278,77	5,33	416 297 379
291,47	5,33	416 297 380
304,17	5,33	416 297 381
329,57	5,33	416 297 382
354,97	5,33	416 297 383
380,37	5,33	416 297 384
405,26	5,33	416 297 385
430,66	5,33	416 297 386
456,06	5,33	416 297 387
481,41	5,33	416 297 388
506,81	5,33	416 297 389
532,21	5,33	416 297 390

Innen-Ø mm Inner-Ø mm	Schnur-Ø mm Cord-Ø mm	Art.-Nr.
532,21	5,33	416 297 390
557,61	5,33	416 297 391
582,68	5,33	416 297 392
608,08	5,33	416 297 393
633,48	5,33	416 297 394
658,88	5,33	416 297 395
Innen-Ø mm Inner-Ø mm	Schnur-Ø mm Cord-Ø mm	Art.-Nr.
113,67	6,99	416 299 425
116,84	6,99	416 299 426
120,02	6,99	416 299 427
123,19	6,99	416 299 428
126,37	6,99	416 299 429
129,54	6,99	416 299 430
132,72	6,99	416 299 431
135,89	6,99	416 299 432
139,07	6,99	416 299 433
142,24	6,99	416 299 434
145,42	6,99	416 299 435
148,59	6,99	416 299 436
151,77	6,99	416 299 437
158,12	6,99	416 299 438
164,47	6,99	416 299 439
170,82	6,99	416 299 440
177,17	6,99	416 299 441
183,52	6,99	416 299 442
189,87	6,99	416 299 443
196,22	6,99	416 299 444
202,57	6,99	416 299 445
215,27	6,99	416 299 446
240,67	6,99	416 299 448
253,57	6,99	416 299 449
266,07	6,99	416 299 450
278,77	6,99	416 299 451
291,47	6,99	416 299 452
304,17	6,99	416 299 453
316,87	6,99	416 299 454
329,57	6,99	416 299 455
342,27	6,99	416 299 456
354,97	6,99	416 299 457
367,67	6,99	416 299 458

380,37	6,99	416 299 459
393,07	6,99	416 299 460
405,26	6,99	416 299 461
417,96	6,99	416 299 462
430,66	6,99	416 299 463
443,36	6,99	416 299 464
456,06	6,99	416 299 465
468,76	6,99	416 299 466
481,48	6,99	416 299 467
494,16	6,99	416 299 468

O-Ringheber-Satz

O-ring jack-set

Bezeichnung
description
O-Ringheber

Art.-Nr.
209 034



Notizen/notes

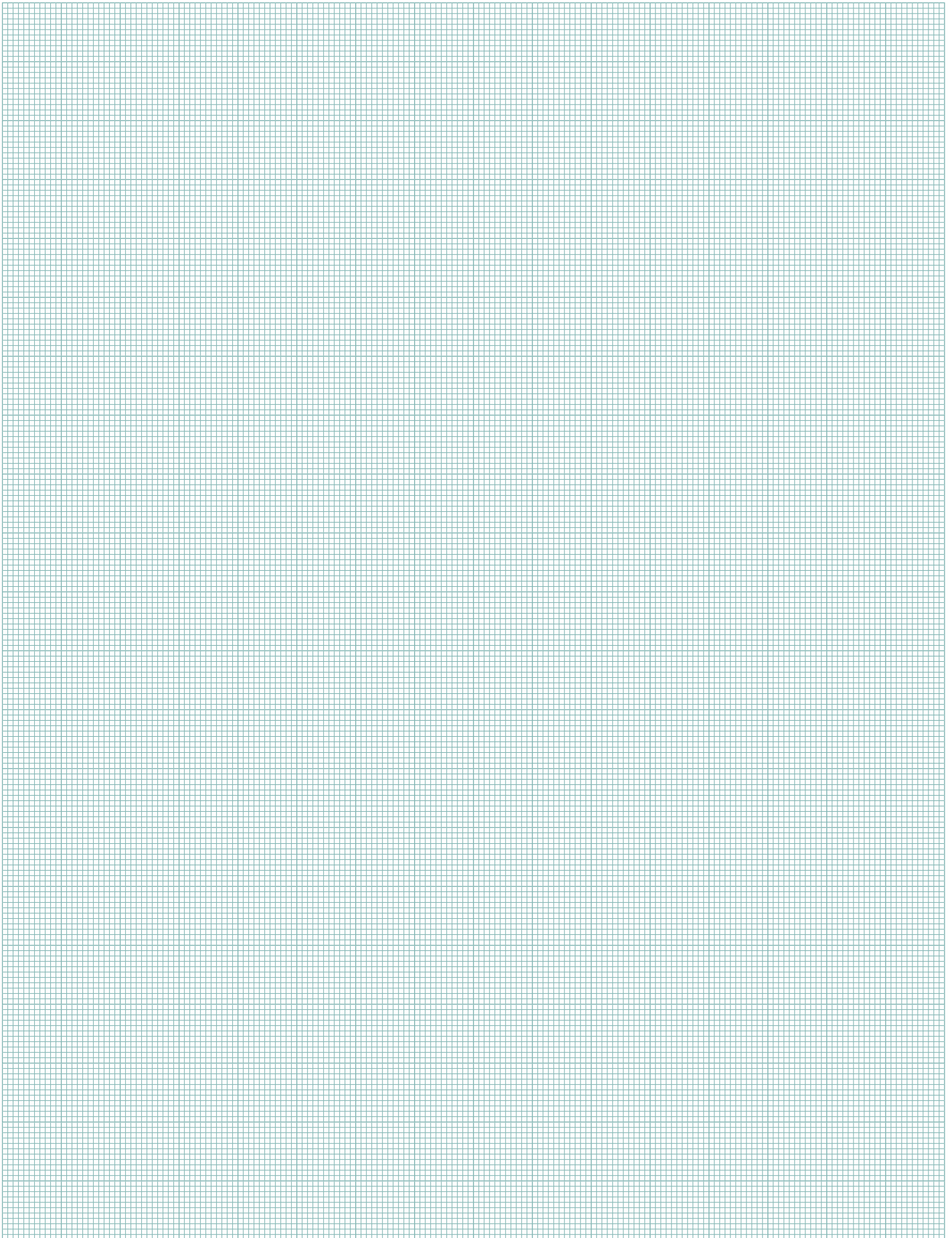

Zentralschmierung

Central lubrication

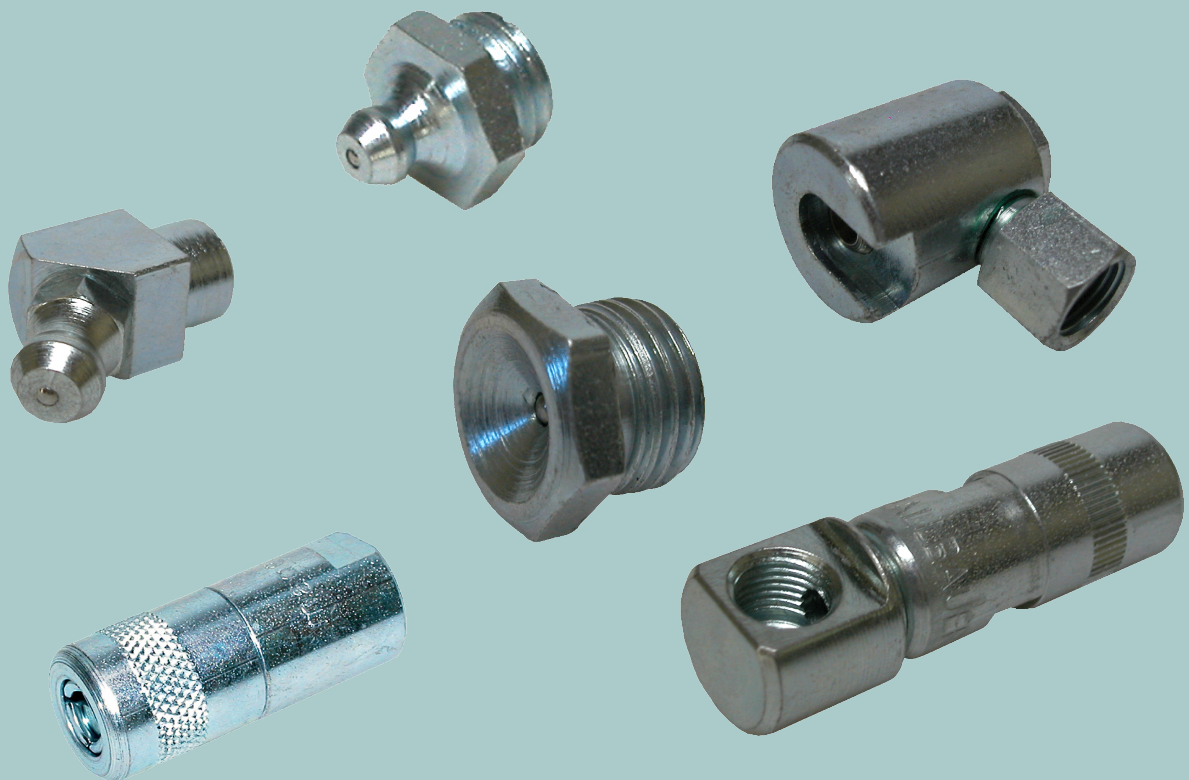

Rohrverschraubungen und Doppelkegelringe

pipe connections and double-conical rings

Überwurfschrauben und Kegelringe

union nuts and conical rings

Rohrverbinder

pipe connectors

Verschlussschrauben

plugs

Drehgelenke

swivel joints

Anschlussstücke

connecting pieces

gerade und Winkel Einschraub-Steckverbinder

straight and angle male plug connectors

Schmiernippel und Zubehör

lubricate nipples and accessories

Verteilerblöcke

distributions blocks

Fettpressen

lubrication guns

Rückschlagventile

check valves

Rohrverschraubungen

pipe connections



zur Montage mit Doppelkegelringen

Werkstoff: Stahl verzinkt

for the assembly with double-conical rings

material: steel galvanized

Rohr Außen-Ø/mm pipe external-Ø/mm	Gewinde thread	Gesamtlänge/mm overall length/mm	SW	Bezeichnung description	Art.-Nr.
2,5	M 6X0,75	9	7	RV 6X0,75/2,5	221 61 06 75
4	M 8X1	12	8	RV 8X1/4	221 61 08 10
6	M 10X1	13	10	RV 10X1/6	221 61 10 10
8	M 12X1	16	12	RV 12X1/8	221 61 12 10
8	M 14X1,5	16	14	RV 14X1,5/8	221 61 14 15
10	M 16X1,5	17	17	RV 16X1,5/10	221 61 16 15
12	M 18X1,5	18	19	RV 18X1,5/12	221 61 18 15

Doppelkegelringe

double-conical rings



DIN 3862

Werkstoff: Messing MS 58

material: brass MS 58

Rohr Außen-Ø/mm pipe external-Ø/mm	Gesamtlänge/mm overall length/mm	Bezeichnung description	Art.-Nr.
2,5	4	K 2,5	221 62 02 50
4	5,5	K 4	221 62 04 00
5	5,5	K 5	221 62 05 00
6	6,5	K 6	221 62 06 00
8	6,5	K 8	221 62 08 00
10	7,5	K 10	221 62 10 00
12	8	K 12	221 62 12 00

Überwurfschrauben

male fitting



zur Montage mit Kegelringen

Werkstoff: Messing MS 58

for the assembly with cone rings

material: brass MS 58

Rohr Außen-Ø/mm pipe external-Ø/mm	Gewinde thread	Gesamtlänge/mm overall length/mm	SW	Bezeichnung description	Art.-Nr.
2,5	M 6X0,75	9	7	ÜWS M6X0,75/2,5 mm PO	221 64 06 75
4	M 8X1	12	8	ÜWS M8X1/4 mm PO	221 64 08 10
6	M 10X1	13	10	ÜWS M10X1/6 mm PO	221 64 10 10
8	M 14X1,5	16	14	ÜWS M14X1,5/8 mm PO	221 64 14 15
10	M 16X1,5	17	17	ÜWS M16X1,5/10 mm PO	221 64 16 15
12	M 18X1,5	18	19	ÜWS M18X1,5/12 mm PO	221 64 18 15

Kegelringe conical rings

mit Führungsschaft

Werkstoff: Messing MS 58

with guidance shank

material: brass MS 58

Rohr Außen-Ø/mm pipe external-Ø/mm	Gesamtlänge/mm overall length/mm	Bezeichnung description	Art.-Nr.
2,5	5,75	KR f. PO 2,5 mm	221 57 02 50
4	8	KR f. PO 4 mm	221 57 04 00
6	9,5	KR f. PO 6 mm	221 57 06 00
8	11	KR f. PO 8 mm	221 57 08 00
10	12,5	KR f. PO 10 mm	221 57 10 00
12	14	KR f. PO 12 mm	221 57 12 00



Doppelkegel für Nylonrohr couple-conical rings for nylon pipe

Werkstoff: Messing MS 58

material: brass MS 58

Rohr Außen-Ø pipe external-Ø mm	Gesamtlänge total length mm	Art.-Nr.
4	6	221 56 04 00
6	6,5	221 56 06 00
8	7	221 56 08 00
10	8	221 56 10 00
12		221 56 12 00



Schott-Rohrverbinder bulkhead pipe connectors

mit metrischem Innengewinde

Werkstoff: Stahl verzinkt

with metric internal thread

material: steel galvanized

Rohr Außen-Ø pipe external-Ø mm	Außengewinde external thread	Innengewinde internal thread	Gesamtlänge overall length mm	SW	Art.-Nr.
4 - 4	M 12X1	M 8X1	27	14	221 69 12 08
4 - 4	M 14X1,5	M 8X1	27	17	221 69 14 08
6 - 6	M 14X1,5	M 10X1	30	17	221 69 14 10
8 - 8	M 16X1,5	M 14X1,5	35	19	221 69 16 14
8 - 8	M 20X1,5	M 12X1	40	24	221 69 20 12
8 - 8	M 20X1,5	M 14X1,5	40	24	221 69 20 14
10 - 10	M 20X1,5	M 16X1,5	42	24	221 69 20 16
12 - 12	M 24X1,5	M 18X1,5	48	27	221 69 24 18



Gegenmuttern finden Sie im Hydraulikkatalog Teil 1

Nuts you find in the hydraulic catalogue part 1

Rohr-Verbindungs-muffen

pipe connection sleeves



Werkstoff: Stahl verzinkt
material: steel galvanized

Rohr Außen-Ø/mm pipe external-Ø/mm	Innengewinde internal thread	Gesamtlänge/mm overall length/mm	SW	Art.-Nr.
4 - 4	M 8X1	27	11	221 65 08 08
6 - 6	M 10X1	30	14	221 65 10 10
6 - 8	M 10X1 / M 14X1,5	35	17	221 65 10 14
8 - 8	M 12X1	40	17	221 65 12 12
8 - 8	M 14X1,5	40	17	221 65 14 14
10 - 10	M 16X1,5	42	19	221 65 16 16
12 - 12	M 18X1,5	48	22	221 65 18 18

Verschluss-schrauben

plugs



Werkstoff: Stahl verzinkt
material: steel galvanized

Gewinde thread	Einschraublänge/mm -in length/mm	SW	Bezeichnung description	Art.-Nr.
M 6X0,75			VS-ZS M6X0,75	223 360
M 8X1	6	11	VS-ZS M8	223 361
M 10X1	7	12	VS-ZS M10	223 362
M 12X1	7	14	VS-ZS M12	223 363
M 14X1,5	7	17	VS-ZS M14	223 364
M 16X1,5	8	19	VS-ZS M16	223 365
M 18X1,5	10	22	VS-ZS M18	223 366
G 1/8"	7	12	VS-ZS R1/8"	223 371
G 1/4"	12	17	VS-ZS R1/4"	223 372
G 3/8"	12	21	VS-ZS R3/8"	223 373
G 1/2"	14	27	VS-ZS R1/8"	223 374

Schneidring-Verschraubungen finden Sie in unserem Hydraulik-katalog Teil 1, Sortimente für die Zentralschmierung in diesem Katalog in dem Kapitel „Sortimente“.

Cutting ring connectors you find in our hydraulic catalogue part 1, assortments for the central lubrication in this catalogue under the section “assortments”.

Schraub-Drehgelenke 90°

screw swivel joints 90°



360° drehbar
Werkstoff: Messing MS 58
360° pivotable
material: brass MS 58

Rohr Außen-Ø/mm pipe external-Ø/mm	Einschraubgewinde screw-in thread	Bezeichnung description	Art.-Nr.
6	M 6X1 keg.	DG-M6X1/PO 6	221 71 06 00
6	M 8X1	DG-M8X1/PO 6	221 71 08 00
6	M 10X1	DG-M10X1/PO 6	221 71 10 00
6	G 1/8"	DG-R1/8"/PO6	221 71 31 00
6	G 1/4"	DG-R1/4"/PO6	221 71 32 00

Steck-Drehgelenke 90° swivel plug joints 90°

360° drehbar

Werkstoff: Messing MS 58

360° pivotable

material: brass MS 58

Rohr Außen-Ø/mm pipe external-Ø/mm	Einschraubgewinde screw-in thread	Bezeichnung description	Art.-Nr.
6	M 6X1 keg.	DG-M6X1/PO 6 SV	221 80 06 06
6	M 8X1	DG-M8X1/PO 6 SV	221 80 06 08
6	M 10X1 keg.	DG-M10X1/PO 6 SV	221 80 06 10
6	G 1/8"	DG-R1/8/PO 6 SV	221 80 06 31
6	G 1/4"	DG-R1/4/PO 6 SV	221 80 06 32

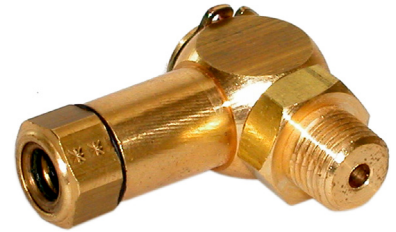

Steck-Schwenkverschraubungen swivel plug connections

Werkstoff: Messing MS 58

material: brass MS 58

Rohr Außen-Ø/mm pipe external-Ø/mm	Einschraubgewinde screw-in thread	Bezeichnung description	Art.-Nr.
6	M 10X1 keg.	SWV-M6X1/PO 6 SV	221 81 06 10
6	G 1/8"	SWV-R1/8/PO 6 SV	221 81 06 31



Kniestücke elbows

mit kegeligem Einschraubgewinde

Werkstoff: Messing

with tapered screw-in thread

material: brass

Rohr Außen-Ø/mm pipe external-Ø/mm	Außengewinde external thread	Innengewinde internal thread	Art.-Nr.
2,5	M 6X1	M 6X0,75	221 70 05 08
4	M 6X0,75 keg.	M 8X1	221 70 05 05
4	M 6X1 keg.	M 8X1	221 70 06 08
4	M 8X1 keg.	M 8X1	221 70 08 08
4	M 10X1 keg.	M 8X1	221 70 10 08
4	G 1/8"	M 8X1	221 70 31 08





mit kegeligem Einschraubgewinde

Werkstoff: Stahl verzinkt

with tapered screw-in thread

material: galvanized steel

Rohr Außen-Ø/mm pipe external-Ø/mm	Außengewinde external thread	Innengewinde internal thread	Gesamtlänge/mm total length/mm	Art.-Nr.
2,5	M 6X0,75 keg.	M 6X0,75		221 53 06 06
2,5	M 8X1	M 6X0,75		221 53 08 06
4	M 6X1 keg.	M 8X1		221 53 06 08
4	M 8X1 keg.	M 8X1		221 53 08 07
4	M 8X1 keg.	M 8X1	32	221 53 08 08
4	M 8X1 keg.	M 8X1	62	221 53 08 09
4	M 10X1 keg.	M 8X1		221 53 10 08
4	G 1/4" keg.	M 8X1		221 53 32 08
4	G 1/8" keg.	M 8X1		221 53 31 08
6	M 8X1	M 10X1		221 53 08 10
6	M 10X1 keg.	M 10X1		221 53 10 10
6	M 10X1 keg.	M 10X1	23	221 53 10 11
6	M 10X1 keg.	M 10X1	35	221 53 10 12
6	M 10X1 keg.	M 10X1	40	221 53 10 13
6	M 10X1 keg.	M 10X1	50	221 53 10 14
6	M 12X1 keg.	M 10X1		221 53 12 10
6	G 1/8" keg.	M 10X1		221 53 31 10
6	G 1/4" keg.	M 10X1		221 53 32 10
8	G 1/8" keg.	M 14X1,5		221 53 31 14
	G 1/8" keg.	G 1/8"	18	221 53 31 21
	G 1/8" keg.	G 1/8"	23	221 53 31 22
	G 1/8" keg.	G 1/8"	35	221 53 31 23
	G 1/8" keg.	G 1/8"	50	221 53 31 24
	G 1/8" keg.	G 1/4"	22	221 53 31 32
	G 1/4" keg.	G 1/8"	20	221 53 32 31
	G 1/4" keg.	G 3/8"	27	221 53 32 33

Kniestücke elbows

mit metrischem Gewinde

Werkstoff: Zink-Druckguss

with metric thread

material: zinc-die casting



Rohr Außen-Ø/mm pipe external-Ø/mm	Außengewinde external thread	Innengewinde internal thread	Bezeichnung description	Art.-Nr.
4	M 12X1 keg.	M 8X1	KNIE M12X1/4 ZK	221 70 12 08
4	G 1/8"	M 8X1	KNIE R1/8~/4 ZK	221 70 31 09
6	M 8X1 keg.	M 10X1	KNIE M8X1/6 ZK	221 70 08 10
6	M 10X1 keg.	M 10X1	KNIE M10X1/6 ZK	221 70 10 10
6	M 12X1 keg.	M 10X1	KNIE M12X1/6 ZK	221 70 12 10
8	M 12X1 keg.	M 14X1,5 keg.	KNIE M12X1/8 ZK	221 70 12 14
8	M 14X1,5 keg.	M 14X1,5 keg.	KNIE M14X1,5/8 ZK	221 70 14 14

T-Verschraubungen tee screw connections

Werkstoff: Stahl verzinkt

material: steel galvanized

Außengewinde external thread	Innengewinde internal thread	Rohranschluss pipe connection	Art.-Nr.
M 10X1	M 10X1	6	221 60 10 10
G 1/8"	G 1/8"	6	221 60 31 10



Überwurfmutter union nuts

Werkstoff: Messing MS 58

material: brass MS 58

Gewinde thread	Rohranschluss pipe connection	Art.-Nr.
M 8X1	4	221 63 08 10
M 10X1	6	221 63 10 10
M 12X1	8	221 63 12 10



Rohrverbinder mit Halterung

pipe connectors with mounting



Werkstoff: Druckguss
material: die casting

Gewinde thread	Rohranschluss pipe connection	Art.-Nr.
M 8X1	5	221 66 08 08
M 10X1	6	221 66 10 10
M 12X1	8	221 66 12 12
M 14X1,5	8	221 66 14 14

Rohrverbinder Winkel 90°

pipe connection angle pieces 90°



Werkstoff: Druckguss
material: die casting

Gewinde thread	Rohranschluss pipe connection	Art.-Nr.
M 10X1	6	221 67 10 10
M 12X1	8	221 67 12 12
M 14X1,5	8	221 67 14 14
M 16X1,5	10	221 67 16 16

Rohrverbinder Winkel 90° mit Halterung

pipe connection angle pieces 90° with mounting



Werkstoff: Druckguss
material: die casting

Gewinde thread	Rohranschluss pipe connection	Art.-Nr.
M 12X1	8	221 68 12 12
M 14X1,5	8	221 68 14 14
M 16X1,5	10	221 68 16 16

Rohrverbinder-T-Verschraubungen

pipe tee screw connections



Werkstoff: Druckguss
material: die casting

Gewinde thread	Gewinde Abgang thread outlet	Rohranschluss pipe connection	Rohranschluss Abgang pipe connection outlet	Art.-Nr.
M 8X1	M 8X1	4	4	221 72 08 08
M 10X1	M 8X1	6	4	221 72 10 08
M 10X1	M 10X1	6	6	221 72 10 10
M 12X1	M 12X1	8	8	221 72 12 12
M 14X1,5	M 14X1,5	8	8	221 72 14 14
M 16X1,5	M 16X1,5	10	10	221 72 16 16

Rohrverbinder-T-Verschraubungen mit Halterung

pipe tee screw connections with mounting

Werkstoff: Druckguss
material: die casting



Gewinde thread	Gewinde Abgang thread outlet	Rohranschluss pipe connection	Rohranschluss Abgang pipe connection outlet	Art.-Nr.
M 8X1	M 8X1	4	4	221 73 08 08
M 10X1	M 10X1	6	6	221 73 10 10
M 12X1	M 12X1	8	8	221 73 12 12
M 14X1,5	M 10X1	8	6	221 73 14 10
M 14X1,5	M 14X1,5	8	8	221 73 14 14
M 16X1,5	M 16X1,5	10	10	221 73 16 16

Nippelblöcke mit T-Bohrung

nipple blocks with T bore hole

Werkstoff: Stahl verzinkt
material: steel galvanized

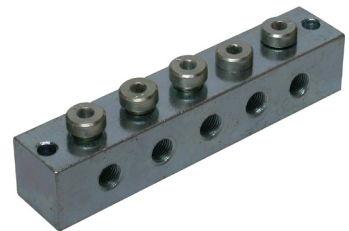

Gewinde thread	Aschlüsse connections	Art.-Nr.
M 10X1	3	221 59 10 01
M 10X1	6	221 59 10 02
M 10X1	9	221 59 10 03
M 10X1	12	221 59 10 04
M 10X1	15	221 59 10 05
M 10X1	18	221 59 10 06
M 10X1	24	221 59 10 08

Verteilerblöcke, einfach

distribution blocks, single

Werkstoff: Stahl verzinkt
material: steel galvanized

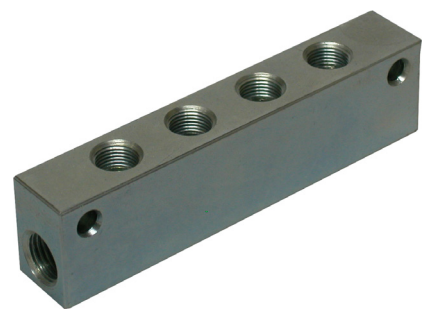

RA mm	Gewinde Eingang thread inlet	Gewinde Ausgang thread outlet	D3 mm	L1 mm	L2 mm	L3 mm	L4 mm	Art.-Nr.
4	M 8X1	1x M 8X1	5,5	30	19	20	10	221 74 08 01
4	M 8X1	2x M 8X1	5,5	46	35	20	10	221 74 08 02
4	M 8X1	3x M 8X1	5,5	62	51	20	10	221 74 08 03
4	M 8X1	4x M 8X1	5,5	78	67	20	10	221 74 08 04
4	M 8X1	5x M 8X1	5,5	94	83	20	10	221 74 08 05
4	M 8X1	6x M 8X1	5,5	110	99	20	10	221 74 08 06
4	M 8X1	7x M 8X1	5,5	126	115	20	10	221 74 08 09
4	M 8X1	8x M 8X1	5,5	142	131	20	10	221 74 08 10
6	M 10X1	1x M 10X1	5,5	35	24	25	15	221 74 10 01
6	M 10X1	2x M 10X1	5,5	53	42	25	15	221 74 10 02
6	M 10X1	3x M 10X1	5,5	71	60	25	15	221 74 10 03
6	M 10X1	4x M 10X1	5,5	89	78	25	15	221 74 10 04
6	M 10X1	5x M 10X1	5,5	107	96	25	15	221 74 10 05
6	M 10X1	6x M 10X1	5,5	125	114	25	15	221 74 10 06
6	M 10X1	7x M 10X1	5,5	143	132	25	15	221 74 10 07
6	M 10X1	8x M 10X1	5,5	161	143	25	15	221 74 10 08

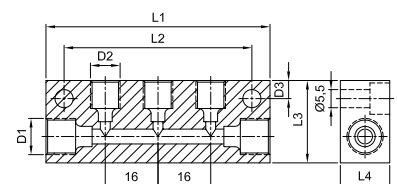

Verteilerblöcke, doppelt

distribution blocks, double

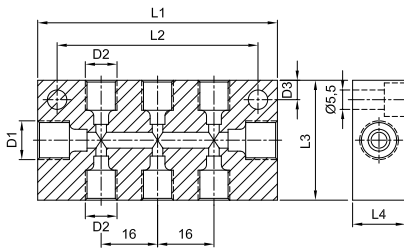

Werkstoff: Stahl verzinkt
material: steel galvanized

RA mm	Gewinde Eingang thread inlet	Gewinde Ausgang thread outlet	D3 mm	L1 mm	L2 mm	L3 mm	L4 mm	Art.-Nr.
4	M 8X1	1x M 8X1	5,5	30	20	30	10	221 75 08 01
4	M 8X1	2x M 8X1	5,5	46	35	30	10	221 75 08 02
4	M 8X1	3x M 8X1	5,5	62	51	30	10	221 75 08 03
4	M 8X1	4x M 8X1	5,5	78	67	30	10	221 75 08 04
4	M 8X1	5x M 8X1	5,5	94	83	30	10	221 75 08 05
4	M 8X1	6x M 8X1	5,5	110	99	30	10	221 75 08 06
4	M 8X1	7x M 8X1	5,5	126	115	30	10	221 75 08 07
4	M 8X1	8x M 8X1	5,5	142	131	30	10	221 75 08 08
6	M 10X1	1x M 10X1	5,5	35	24	35	15	221 75 10 02
6	M 10X1	2x M 10X1	5,5	53	42	35	15	221 75 10 04
6	M 10X1	3x M 10X1	5,5	71	60	35	15	221 75 10 06
6	M 10X1	4x M 10X1	5,5	89	78	35	15	221 75 10 08
6	M 10X1	5x M 10X1	5,5	107	96	35	15	221 75 10 10
6	M 10X1	6x M 10X1	5,5	125	114	35	15	221 75 10 12
6	M 10X1	7x M 10X1	5,5	143	132	35	15	221 75 10 14
6	M 10X1	8x M 10X1	5,5	161	150	35	15	221 75 10 16

gerade Steckverbinder

straight plug connectors

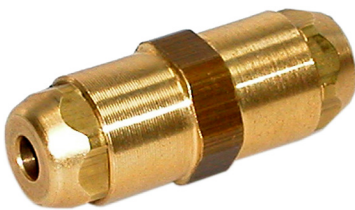

Werkstoff: Messing MS 58
material: brass MS 58

Rohr Außen-Ø/mm pipe external-Ø/mm	Bezeichnung description	Art.-Nr.
4	G-4 SV MS	221 76 04 04
6	G-6 SV MS	221 76 06 06
8	G-8 SV MS	221 76 08 08

T-Steckverbinder

Tee plug connectors



Werkstoff: Messing MS 58
material: brass MS 58

Rohr Außen-Ø/mm pipe external-Ø/mm	Bezeichnung description	Art.-Nr.
4	T-4 SV MS	221 77 04 00
6	T-6 SV MS	221 77 06 00
8	T-8 SV MS	221 77 08 00

gerade Einschraub-Steckverbinder

straight male connections

metrisches bzw. zölliges Einschraubgewinde, kegelig

Werkstoff: Messing MS 58

metric or inch male thread, conical

material: brass MS 58



Rohr Außen-Ø/mm pipe external-Ø/mm	Einschraubgewinde -in thread	Bezeichnung description	Art.-Nr.
4	M 6X1 keg.	GE-M6X1/4 PO SV	221 78 04 06
4	M 8X1 keg.	GE-M8X1/4 PO SV	221 78 04 08
4	M 10X1 keg.	GE-M10X1/4 PO SV	221 78 04 10
4	G 1/8"	GE-R1/8~/4 PO SV	221 78 04 31
4	G 1/4"	GE-R1/4~/4 PO SV	221 78 04 32
6	M 6X1 keg.	GE-M6X1/6 PO SV	221 78 06 06
6	M 8X1 keg.	GE-M8X1/6 PO SV	221 78 06 08
6	M 10X1 keg.	GE-M10X1/6 PO SV	221 78 06 10
6	M 12X1 keg.	GE-M12X1/6 PO SV	221 78 06 12
6	G 1/8"	GE-R1/8~/6 PO SV	221 78 06 31
6	G 1/4"	GE-R1/4~/6 PO SV	221 78 06 32
8	M 12X1 keg.	GE-M12X1/8 PO SV	221 78 08 12
10	M 14X1,5	GE-M14X1,5/10 PO SV	221 78 10 14

Winkel Einschraub-Steckverbinder

angle male connections

metrisches bzw. zölliges Einschraubgewinde, kegelig

Werkstoff: Messing MS 58

metric or inch male thread, conical

material: brass MS 58



Rohr Außen-Ø/mm pipe external-Ø/mm	Einschraubgewinde -in thread	Bezeichnung description	Art.-Nr.
4	M 6X1 keg.	WE-M6X1/4 PO SV	221 79 04 06
4	M 8X1 keg.	WE-M8X1/4 PO SV	221 79 04 08
4	M 10X1 keg.	WE-M10X1/4 PO SV	221 79 04 10
4	G 1/8"	WE-R1/8~/4 PO SV	221 79 04 31
4	G 1/4"	WE-R1/4~/4 PO SV	221 79 04 32
6	M 6X1 keg.	WE-M6X1/6 PO SV	221 79 06 06
6	M 8X1 keg.	WE-M8X1/6 PO SV	221 79 06 08
6	M 10X1 keg.	WE-M10X1/6 PO SV	221 79 06 10
6	M 12X1 keg.	WE-M12X1/6 PO SV	221 79 06 12
6	G 1/8"	WE-R1/8~/6 PO SV	221 79 06 31
6	G 1/4"	WE-R1/4~/6 PO SV	221 79 06 32
8	M 12X1 keg.	WE-M12X1/8 PO SV	221 79 08 12

Polyamidrohr, fettgefüllt

polyamid pipe, fat-filled



Außen-Ø external-Ø mm	Wandstärke thickness mm	Lieferlänge delivery length m	Art.-Nr.
4	0,85	50	672 012 50
6	1,5	25	672 002 25
6	1,5	100	672 002 01

Hochdruckschlauch - Typ AF

high pressure hose y type AF

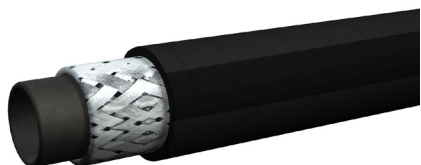

Schlauchkonstruktion:

Seele: Polyamid 11

Einlage: Polyestergeflecht (CU = mit Kupferlitze)

Decke: Polyurethan, witterungs- und alterungsbeständig bis 80° C

Temperaturbereich: -60° C bis +100° C

Lieferlänge von AF fettgefüllt: 50 m

hose construction:

inner layer: Polyamid 11

reinforcement: Polyester network (CU = with copper braid)

cover: Polyurethan, weather and age-resistant to +80°C

temperature range: -60° C to +100° C

delivery length of AF fat-filled: 50 m

DN NS	Innen-Ø external-Ø mm	Außen-Ø internal-Ø mm	Betriebsdruck working pressure bar	Berstdruck peak pressure bar	Biegeradius bend radius mm	Bezeichnung description	Art.-Nr.
4	4,0	8,1	370	820	40	AF 4 CU	622 354
6,3	6,3	11,2	255	560	63	AF 6,3	622 366
4	4,0	8,1	370	820	40	AF 4 CU fettgefüllt	622 355
4	4,0	8,1	370	820	40	AF 4 fettgefüllt	622 365
6,3	6,3	11,2	255	560	63	AF 6,3 fettgefüllt	622 367

Schraubfassungen

screw socket



Achtung: Die Fassung linksherum auf den Schlauch aufschrauben!

Note: The socket screw to the left onto the hose!

DN NS	SW	Länge length	Bezeichnung description	Art.-Nr.
4	12	25	HAF 4	420 910
6	17	36	HAF 6,3	420 911

Schraubnippel

screw nipples

Rohrstutzen für Doppelkegelringe und Rohrverschraubungen bzw. Kegelringe und Überwurfschrauben

Tube end for double-cone rings and pipe joints or
Cone rings and male fittings

BE gerade/straight

DN NS	Rohranschluss pipe connection	Bezeichnung description	Art.-Nr.
4	6	BE 6-L	421 910
6,3	8	BE 8-L	421 911

BE 45°

DN NS	Rohranschluss pipe connection	Bezeichnung description	Art.-Nr.
4	6	BE 6-L 45°	421 950

BE 90°

DN NS	Rohranschluss pipe connection	Bezeichnung description	Art.-Nr.
4	6	BE 6-L 90°	421 955

CEL

DN NS	Rohranschluss pipe connection	Gewinde thread	Bezeichnung description	Art.-Nr.
4	6	M 12X1,5	CE 6-L	421 920
6,3	8	M 14X1,5	CE 8-L	421 921

DKL/DKR

DN NS	Rohranschluss pipe connection	Gewinde thread	Bezeichnung description	Art.-Nr.
4	6	M 12X1,5	DKL 6-L	421 940
4		R 1/4"	DKR 1/4"	421 930
6,3	8	M 14X1,5	DKL 8-L	421 941
6,3	10	M 16X1,5	DKL 10-L	421 942
6,3		R 1/4"	DKR 1/4"	421 931



Schmiernippel DIN 71412

lubrication nipples DIN 71412



H1

Gewinde thread	Bezeichnung description	Werkstoff material	Art.-Nr.
M 5X0,8	SN 5	Stahl verzinkt/steel zinc-plated	221 01 05 08
M 6X1	SN 6	Stahl verzinkt/steel zinc-plated	221 01 06 10
M 6X1 zyl	SN 6 zyl	Stahl verzinkt/steel zinc-plated	221 01 06 11
M 6X1	SN 6	Edelstahl/stainless steel	221 01 06 10v
M 7X1	SN 7	Stahl verzinkt/steel zinc-plated	221 01 07 10
M 8X1	SN 8	Stahl verzinkt/steel zinc-plated	221 01 08 10
M 8X1	SN 8	Edelstahl/stainless steel	221 01 08 10v
M 8X1,25	SN 8X1,25	Stahl verzinkt/steel zinc-plated	221 01 08 12
M 10X1	SN 10	Stahl verzinkt/steel zinc-plated	221 01 10 10
M 10X1	SN 10	Edelstahl/stainless steel	221 01 10 10v
M 10X1,25	SN 10X1,25	Stahl verzinkt/steel zinc-plated	221 01 10 12
M 10X1,5	SN 10X1,5	Stahl verzinkt/steel zinc-plated	221 01 10 15
M 10X1,5	SN 10X1,5	Edelstahl/stainless steel	221 01 10 15v
M 12X1	SN 12	Stahl verzinkt/steel zinc-plated	221 01 12 10
M 12X1,5	SN 12X1,5	Stahl verzinkt/steel zinc-plated	221 01 12 15
M 14X1,5	SN 14	Stahl verzinkt/steel zinc-plated	221 01 14 15
M 16X1,5	SN16	Stahl verzinkt/steel zinc-plated	221 01 16 15
G 1/8"	SN 1/8"	Stahl verzinkt/steel zinc-plated	221 04 31 00
1/8" NPT	SN 1/8"NPT	Stahl verzinkt/steel zinc-plated	221 04 81 00
G 1/8"	SN 1/8"	Edelstahl/stainless steel	221 04 31 00v
G 1/4"	SN 1/4"	Stahl verzinkt/steel zinc-plated	221 04 32 00
1/4" SAE	SN 1/4"SAE	Stahl verzinkt/steel zinc-plated	221 07 31 00
5/16" SAE	SN 5/16"SAE	Stahl verzinkt/steel zinc-plated	221 07 32 00
G 3/8"	SN 3/8"	Stahl verzinkt/steel zinc-plated	221 04 33 00
3/8" SAE	SN 3/8"SAE	Stahl verzinkt/steel zinc-plated	221 07 33 00
G 1/2"	SN 1/2"	Stahl verzinkt/steel zinc-plated	221 04 34 00

Schmiernippel DIN 71412

lubrication nipples DIN 71412



H2

Gewinde thread	Bezeichnung description	Werkstoff material	Art.-Nr.
M 6X1	SN 6/45°	Stahl verzinkt/steel zinc-plated	221 02 06 10
M 6x1	SN 6/45°	Edelstahl/stainless steel	221 02 06 10v
M 8X1	SN 8/45°	Stahl verzinkt/steel zinc-plated	221 02 08 10
M 8X1	SN 8/45°	Edelstahl/stainless steel	221 02 08 10v
M 8X1,25	SN 8X1,25/45°	Stahl verzinkt/steel zinc-plated	221 02 08 15
M 10X1	SN 10/45°	Stahl verzinkt/steel zinc-plated	221 02 10 10
M 10X1	SN 10/45°	Edelstahl/stainless steel	221 02 10 10v
M 10X1,5	SN 10X1,5/45°	Stahl verzinkt/steel zinc-plated	221 02 10 15
M 10X1,5	SN 10X1,5/45°	Edelstahl/stainless steel	221 02 10 15v
M 12X1	SN 12/45°	Stahl verzinkt/steel zinc-plated	221 02 12 10
M 12X1,5	SN 12X1,5/45°	Stahl verzinkt/steel zinc-plated	221 02 12 15
G 1/8"	SN 1/8"/45°	Stahl verzinkt/steel zinc-plated	221 05 31 00
1/8" NPT	SN 1/8"NPT/45°	Stahl verzinkt/steel zinc-plated	221 05 81 00
G 1/8"	SN 1/8"/45°	Edelstahl/stainless steel	221 05 31 00v
G 1/4"	SN 1/4"/45°	Stahl verzinkt/steel zinc-plated	221 05 32 00
1/4" SAE	SN 1/4"SAE/45°	Stahl verzinkt/steel zinc-plated	221 08 31 00
5/16" SAE	SN 5/16"SAE/45°	Stahl verzinkt/steel zinc-plated	221 08 32 00
3/8" SAE	SN 3/8"SAE/45°	Stahl verzinkt/steel zinc-plated	221 08 33 00

Schmiernippel DIN 71412

lubrication nipples DIN 71412

H3
H3

Gewinde thread	Bezeichnung description	Werkstoff material	Art.-Nr.
M 6X1	SN 6/90°	Stahl verzinkt/steel zinc-plated	221 03 06 10
M 6x1	SN 6/90°	Edelstahl/stainless steel	221 03 06 10v
M 8X1	SN 8/90°	Stahl verzinkt/steel zinc-plated	221 03 08 10
M 8x1	SN 8/90°	Edelstahl/stainless steel	221 03 08 10v
M 8x1,25	SN 8x1,25/90°	Stahl verzinkt/steel zinc-plated	221 03 08 15
M 10X1	SN 10/90°	Stahl verzinkt/steel zinc-plated	221 03 10 10
M 10x1	SN 10/90°	Edelstahl/stainless steel	221 03 10 10v
M 10x1,5	SN 10/90°	Edelstahl/stainless steel	221 03 10 15v
M 12X1	SN 12/90°	Stahl verzinkt/steel zinc-plated	221 03 12 10
M 12X1,5	SN 12X1,5/90°	Stahl verzinkt/steel zinc-plated	221 03 12 15
G 1/8"	SN 1/8"/90°	Stahl verzinkt/steel zinc-plated	221 06 31 00
1/8" NPT	SN 1/8"NPT/90°	Stahl verzinkt/steel zinc-plated	221 06 81 00
G 1/8"	SN 1/8"/90°	Edelstahl/stainless steel	221 06 31 00v
G 1/4"	SN 1/4"/90°	Stahl verzinkt/steel zinc-plated	221 06 32 00
1/4" SAE	SN 1/4"SAE/90°	Stahl verzinkt/steel zinc-plated	221 09 31 00
5/16" SAE	SN 5/16"SAE/90°	Stahl verzinkt/steel zinc-plated	221 09 32 00
3/8" SAE	SN 3/8" SAE/90°	Stahl verzinkt/steel zinc-plated	221 09 33 00



Aufschraubschottverschraubungen

screw bulkhead unions

Werkstoff: Stahl verzinkt
material: steel galvanized

Rohranschluss pipe connection	Innengewinde internal thread	Art.-Nr.
L 6	M 6X1	221 50 06 06
L 6	M 10X1	221 50 06 10



Winkelstücke 45°

angle pieces 45°

Werkstoff: Stahl verzinkt
material: steel galvanized

Außengewinde external thread	Innengewinde internal thread	Art.-Nr.
M 8X1 keg.	M 8X1	221 51 08 08
M 10X1 keg.	M 8X1	221 51 10 08
M 10X1 keg.	M 10X1	221 51 10 10
G 1/8"	R 1/8"	221 51 31 31
G 1/4"	R 1/4"	221 51 32 32



Winkelstücke 90° angle pieces 90°



Werkstoff: Stahl verzinkt
material: steel galvanized

Außengewinde external thread	Innengewinde internal thread	Art.-Nr.
M 6X1 keg.	M 6X1	221 52 06 06
M 6X1 keg.	M 8X1	221 52 06 08
M 8X1 keg.	M 8X1	221 52 08 08
M 10X1 keg.	M 8X1	221 52 10 08
M 10X1 keg.	M 10X1	221 52 10 10
G 1/8"	G 1/8"	221 52 31 31
G 1/8"	M 8X1	221 52 31 08
G 1/4"	G 1/4"	221 52 32 32

Rückschlagventile check valves



Werkstoff: Stahl verzinkt
material: steel galvanized

Gewinde thread	Rohranschluss pipe connection	Bild-Nr. picture nr.	System system	Art.-Nr.
M 10X1	LL 6	1	Beka	221 49 10 01
M 10X1	LL 6	2	Lincoln	221 49 10 02
M 10X1 keg.	LL 6	3	Vogel	221 49 10 03

Schmiernippel selbstschneidend DIN 71412

lubrication nipples self-tapping DIN 71412

H1

Werkstoff: Stahl verzinkt
material: steel galvanized



Gewinde thread	Bezeichnung description	Art.-Nr.
M 6X1	SFG 6	221 10 06 10
M 8X1	SFG 8	221 10 08 10
M 10X1	SFG 10	221 10 10 10

Schmiernippel selbstschneidend DIN 71412

lubrication nipples self-tapping DIN 71412

H2

Werkstoff: Stahl verzinkt
material: steel galvanized



Gewinde thread	Bezeichnung description	Art.-Nr.
M 6X1	SFG 6/45°	221 11 06 10
M 8X1	SFG 8/45°	221 11 08 10
M 10X1	SFG 10/45°	221 11 10 10

Schmiernippel selbstschneidend DIN 71412

lubrication nipples self-tapping DIN 71412

H3

Werkstoff: Stahl verzinkt
material: steel galvanized



Gewinde thread	Bezeichnung description	Art.-Nr.
M 6X1	SFG 6/90°	221 12 06 10
M 8X1	SFG 8/90°	221 12 08 10
M 10X1	SFG 10/90°	221 12 10 10

Einschlag - Schmiernippel

knock in - lubrication nipples



H1
H1

Einschlagzapfen/mm knock-in cone/mm	Bezeichnung description	Werkstoff material	Art.-Nr.
6	ESN 6	Stahl verzinkt/steel zinc-plated	221 13 06 00
6	ESN 6	Edelstahl/stainless steel	221 13 06 00v
8	ESN 8	Stahl verzinkt/steel zinc-plated	221 13 08 00
8	ESN 8	Edelstahl/stainless steel	221 13 08 00v
10	ESN 10	Stahl verzinkt/steel zinc-plated	221 13 10 00

Einschlag - Schmiernippel

knock in - lubrication nipples



H2
H2

Einschlagzapfen/mm knock-in cone/mm	Bezeichnung description	Werkstoff material	Art.-Nr.
6	ESN 6/45°	Stahl verzinkt/steel zinc-plated	221 14 06 00
8	ESN 8/45°	Stahl verzinkt/steel zinc-plated	221 14 08 00

Einschlag - Schmiernippel

knock in - lubrication nipples

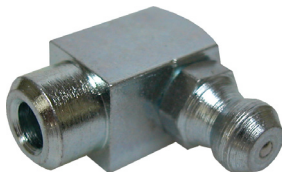

H3
H3

Einschlagzapfen/mm knock-in cone/mm	Bezeichnung description	Werkstoff material	Art.-Nr.
6	ESN 6/90°	Stahl verzinkt/steel zinc-plated	221 15 06 00
8	ESN 8/90°	Stahl verzinkt/steel zinc-plated	221 15 08 00

Schutzkappen protection caps

Ausführung type	Bezeichnung description	Farbe colour	Art.-Nr.
mit Lasche/with plate	KU-SK	gelb/yellow	221 16 06 01
mit Lasche/with plate	KU-SK	rot/red	221 16 06 02
mit Lasche/with plate	KU-SK	grün/green	221 16 06 03
mit Lasche/with plate	KU-SK	schwarz/black	221 16 06 04
ohne Lasche/without plate	KU-SK	gelb/yellow	221 16 06 05
ohne Lasche/without plate	KU-SK	rot/red	221 16 06 06
ohne Lasche/without plate	KU-SK	grün/green	221 16 06 07
ohne Lasche/without plate	KU-SK	schwarz/black	221 16 06 08



Kennzeichnungsringe marking rings

Gewinde thread	Farbe colour	Art.-Nr.
M 6X1	rot/red	221 17 06 01
M 8X1	rot/red	221 17 08 01
M 10X1	rot/red	221 17 10 01
M 10X1	gelb/yellow	221 17 10 02



Trichterschmiernippel

funnel type lubrication nipples



D1
D1

Werkstoff: Stahl verzinkt
material: steel galvanized

Gewinde thread	Bezeichnung description	Art.-Nr.
M 5X0,8	TSN 5	221 18 05 08
M 6X1	TSN 6	221 18 06 10
M 8X1	TSN 8	221 18 08 10
M 10X1	TSN10	221 18 10 10
M 10X1,5	TSN 10X1,5	221 18 10 15
G 1/8"	TSN 1/8"	221 21 31 00
G 1/4"	TSN 1/4"	221 21 32 00
G 3/8"	TSN 3/8"	221 21 33 00

Trichterschmiernippel

funnel type lubrication nipples



D2
D2

Werkstoff: Stahl verzinkt
material: steel galvanized

Gewinde thread	Bezeichnung description	Art.-Nr.
M 6X1	TSN 6/45°	221 19 06 10
M 8X1	TSN 8/45°	221 19 08 10
M 8X1,25	TSN 8X1,25/45°	221 19 08 12
M 10X1	TSN 10/45°	221 19 10 10
G 1/4"	TSN 1/4"/45°	221 22 32 00

Trichterschmiernippel

funnel type lubrication nipples



D3
D3

Werkstoff: Stahl verzinkt
material: steel galvanized

Gewinde thread	Bezeichnung description	Art.-Nr.
M 6X1	TSN 6/90°	221 20 06 10
M 8X1	TSN 8/90°	221 20 08 10
M 10X1	TSN 10/90°	221 20 10 10

Einschlag-Trichterschmiernippel

funnel type lubrication nipples with knock in

D1
D1

Werkstoff: Stahl verzinkt
material: steel galvanized



Einschlagzapfen/ mm knock-in cone/mm	Bezeichnung description	Art.-Nr.
4	ETSN 4	221 23 04 00
5	ETSN 5	221 23 05 00
6	ETSN 6	221 23 06 00
8	ETSN 8	221 23 08 00

Einschlag-Trichterschmiernippel

funnel type lubrication nipples with knock in

D2
D2

Werkstoff: Stahl verzinkt
material: steel galvanized



Einschlagzapfen/mm knock-in cone/mm	Bezeichnung description	Art.-Nr.
6	ETSN 6/45°	221 24 06 00
8	ETSN 8/45°	221 24 08 00

Einschlag-Trichterschmiernippel

funnel type lubrication nipples with knock in

D3
D3

Werkstoff: Stahl verzinkt
material: steel galvanized



Einschlagzapfen/mm knock-in cone/mm	Bezeichnung description	Art.-Nr.
6	ETSN 6/90°	221 25 06 00
8	ETSN 8/90°	221 25 08 00

Flachschmiernippel DIN 3404

flat lubrication nipples DIN 3404



Werkstoff: Stahl verzinkt
material: steel galvanized

Gewinde thread	Bezeichnung description	Kopf-Ø/mm head-Ø/mm	Art.-Nr.
M 6X1	FSN 6	10	221 26 06 10
M 8X1	FSN 8	10	221 26 08 10
M 10X1	FSN 10	10	221 26 10 10
M 6X1	FSN 6	16	221 27 06 10
M 8X1	FSN 8	16	221 27 08 10
M 8X1,25	FSN 8X1,25	16	221 27 08 12
M 10X1	FSN 10	16	221 27 10 10
M 10X1,5	FSN 10X,15	16	221 27 10 15
M 12X1,5	FSN 12X1,5	16	221 27 12 15
M 16X1,5	FSN 16X1,5	16	221 27 16 15
M 16X1,5	FSN 16X1,5	22	221 28 16 15
G 1/8"	FSN 1/8"	16	221 29 31 00
G 1/4"	FSN 1/4"	16	221 29 32 00
G 3/8"	FSN 3/8"	16	221 29 33 00
G 1/2"	FSN 1/2"	16	221 29 34 00
G 1/4"	FSN 1/4"	22	221 30 32 00
G 3/8"	FSN 3/8"	22	221 30 33 00
G 1/2"	FSN 1/2"	22	221 30 34 00

Mundstücke

die

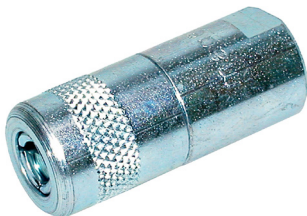

Greifkupplung mit gestanzten Backen
grab clutch with punched cheeks

Gewinde thread	Bezeichnung description	Art.-Nr.
M 10X1	MU-ST M 10X1	221 31 10 10
R 1/8"	MU-ST R 1/8"	221 31 31 00

Mundstücke mit Rückschlagventil

die with check valve



Greifkupplung mit gestanzten Backen
grab clutch with punched cheeks

Gewinde thread	Bezeichnung description	Art.-Nr.
M 10X1	MU-ST 10X1/RSV	221 32 10 10

Fettpressschläuche

lubrication hoses

optimale Verbindung zwischen Presse und Schmierstelle

Werkstoff: Polyamid, Ø 11 mm, DIN 1283

max. Betriebsdruck: 1.000 bar

optimal connection between press and lubrication place

material: polyamid, Ø 11 mm, DIN 1283

max. working pressure: 1.000 bar

Gewinde thread	Länge/mm length/mm	Art.-Nr.
M 10X1	300	221 39 10 30
M 10X1	500	221 39 10 50
G 1/8"	300	221 39 31 30
G 1/8"	500	221 39 31 50



Mundstücke 90°

die 90°

Gewinde thread	Bezeichnung description	Art.-Nr.
M 10X1	MU-ST M 10X1/90°	221 33 10 10
R 1/8"	MU-ST R 1/8"/90°	221 33 31 00



Drehgelenke

swivels

Gewinde thread	Art.-Nr.
M 10X1	221 34 10 10
R 1/8"	221 34 31 00



Schiebekupplungen

push-couplings

Gewinde thread	für Kopf-Ø/mm for head-Ø/mm	Art.-Nr.
M 10X1	10	221 35 10 12
R 1/8"	10	221 35 10 31
M 10X1	16	221 35 16 12
R 1/8"	16	221 35 16 31
M 10X1	22	221 35 22 12
R 1/8"	22	221 35 22 31



Spitzmundstücke für Trichterschmiernippel

tapered dies for funnel type lubrication nipples



Gewinde	Art.-Nr.
thread	
M 10X1	221 36 10 10
R 1/8"	221 36 31 00

Universalmundstücke

universal dies



Gewinde	Art.-Nr.
thread	
M 10X1	221 37 10 10
R 1/8"	221 37 31 00

Schmiernippel Schnellwechselset

lubrication nipples quick-change set



Bezeichnung	Art.-Nr.
description	
	221 38 00 00

Düsenrohre

nozzle tubes

Gewinde	Mundstück	Art.-Nr.
thread	die	
M 10X1	universal/universal	221 38 10 00
G 1/8"	universal/universal	221 38 31 00
M 10X1	4-Backen/4 jaws	221 38 10 04
G 1/8"	4-Backen/4 jaws	221 38 31 04



Profi Fettpressen

professional lubrication guns

schnell befüllbar mit 400gr-Fettpatronen (DIN 1284)
quick refillable with 400gr lubrication cartridges (DIN 1284)

Gewinde thread	
M 10X1	

Art.-Nr.	
221 45 00 01	



Fettpressen

lubrication guns

schnell befüllbar mit 400gr-Fettpatronen (DIN 1284)
quick refillable with 400gr lubrication cartridges (DIN 1284)

Gewinde thread	
M 10X1	

Art.-Nr.	
221 45 00 02	



Profi Stoßpressen, gefüllt

professional push-type lubrication guns, filled

Art.-Nr.	
221 45 00 03	



Kartuschen für Stoßpressen

cartridges for push-type lubrication guns

Art.-Nr.	
221 45 00 04	



Schlauchstopper

hose stop



für Schlauch
for hose

1/4"	
3/8"	
1/2"	

Art.-Nr.

221 47 32 00
221 47 33 00
221 47 34 00

Fasshähne

faucets



Gewinde
thread

G 3/4"	
G 2"	

Art.-Nr.

221 48 36 00
221 48 40 00

Düsenrohr-Schnellkupplungen

nozzle tube quick connectors

Anschluss
connection

universal/universal	
Spitzmundstück/pointed die	
flach 16mm/flat 16mm	
flach 22mm/flat 22mm	

Art.-Nr.

221 38 40 00
221 38 40 01
221 38 40 16
221 38 40 22



Befüllzylinder

filling cylinder

Anschluss
connection

mit Stutzen/connecting piece	
M 26X1,5	

Art.-Nr.

221 54 01 01
221 54 26 15



Befüllanschlüsse

filling connections

	Art.-Nr.
M 20X1,5 f. m. Stutzen	221 55 20 01
M 22X1,5 f. m. Stutzen	221 55 22 01



Kupplungsmuffen m. Rücklaufanschluss

female couplings with response connection

	Art.-Nr.
Kupplungsmuffe m. Rücklaufanschluss	221 58 01 01



Kupplungsstecker

male couplings

	Art.-Nr.
Kupplungsstecker	221 58 51 51



Notizen/notes

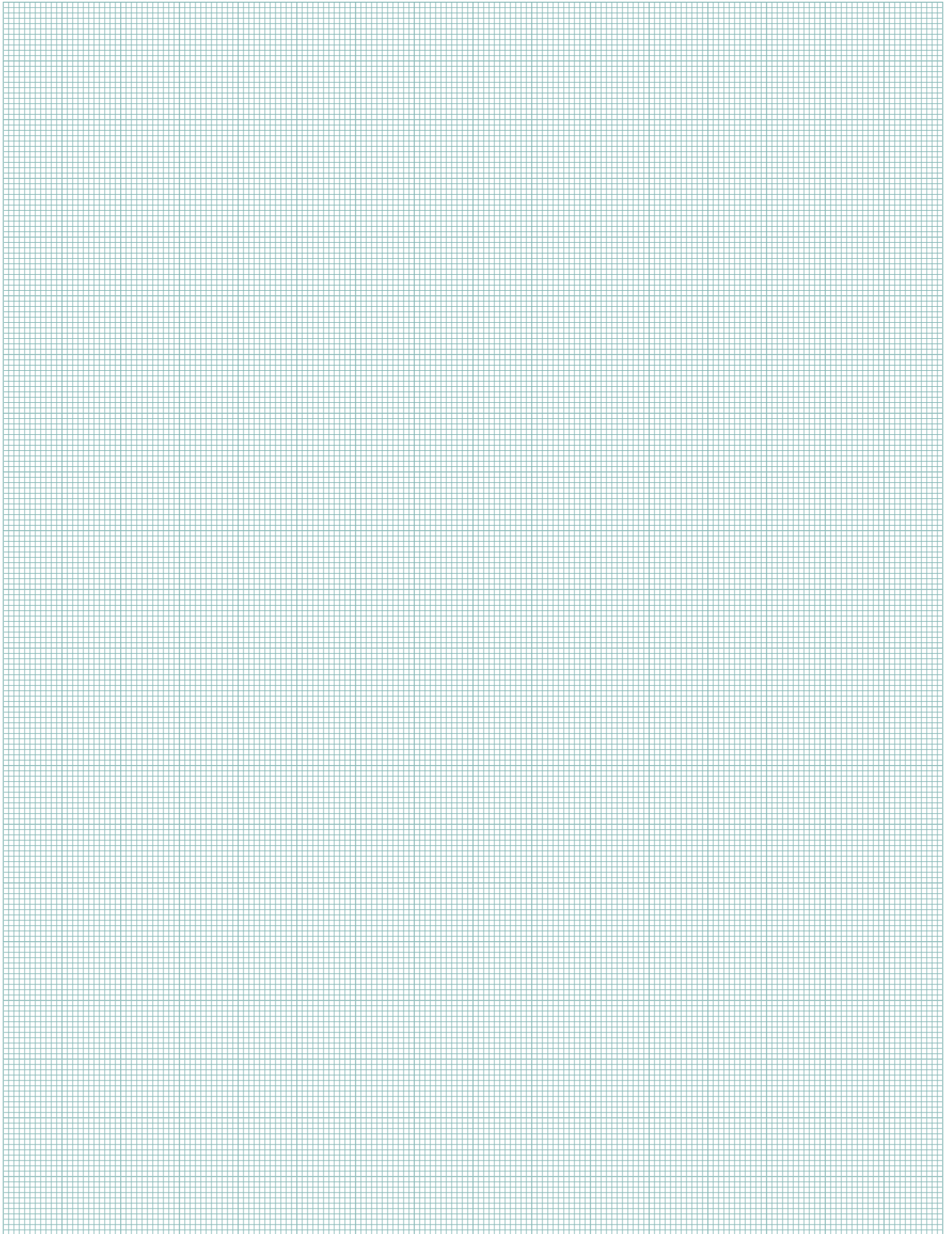

Befestigungstechnik

Fastening technology



Kabelbinder

Befestigungsschellen

Rohrschellen Typ RSGU

Schlauchschellen Typ S

Typ TORRO

Typ TX

Typ Pebra

Typ GBS

Typ Cobra

Cable ties

Fastening clamps

Pipe clamps Type RSGU

Hose clamps Type S

Type TORRO

Type TX

Type Pebra

Type GBS

Type Cobra

Schlauchschellen Typ S

hose clamps type S



DIN 3017

Werkstoff: W1 = alle Teile komplett Stahl, verzinkt

Merkmale: optimale Spannkraftverteilung

DIN 3017

material: W1 = all items complete steel, galvanized

characteristics: optimal spread of elastic force

Durchmesser diameter mm	Bandbreite band width mm	Bezeichnung description	Art.-Nr.
6	7	S 6/7	310 597
7	7	S 7/7	310 598
8	7	S 8/7	310 599
9	9	S 9/9	310 600
10	9	S 10/9	310 601
11	9	S 11/9	310 602
12	9	S 12/9	310 603
13	9	S 13/9	310 604
14	9	S 14/9	310 605
15	9	S 15/9	310 606
16	9	S 16/9	310 608
17	9	S 17/9	310 610
18	9	S 18/9	310 612
19	9	S 19/9	310 614
20	9	S 20/9	310 616
22	9	S 22/9	310 622
15	12	S 15/12	310 607
16	12	S 16/12	310 609
17	12	S 17/12	310 611
18	12	S 18/12	310 613
19	12	S 19/12	310 615
20	12	S 20/12	310 617
21	12	S 21/12	310 620
22	12	S 22/12	310 623
23	12	S 23/12	310 626
24	12	S 24/12	310 629
25	12	S 25/12	310 632
26	12	S 26/12	310 635
27	12	S 27/12	310 638
28	12	S 28/12	310 641
20	15	S 20/15	310 618
21	15	S 21/15	310 621
22	15	S 22/15	310 624
23	15	S 23/15	310 627
24	15	S 24/15	310 630
25	15	S 25/15	310 633
26	15	S 26/15	310 636
27	15	S 27/15	310 639
28	15	S 28/15	310 642
36	20	S 36/20	310 672
37	20	S 37/20	310 676
38	20	S 38/20	310 680
39	20	S 39/20	310 684
40	20	S 40/20	310 688
41	20	S 41/20	310 692
42	20	S 42/20	310 696
43	20	S 43/20	310 700
44	20	S 44/20	310 704
45	20	S 45/20	310 708

Schlauchschellen Typ S

hose clamps type S

DIN 3017

Werkstoff: W1 = alle Teile komplett Stahl, verzinkt

Merkmale: optimale Spannkraftverteilung

DIN 3017

material: W1 = all items complete steel, galvanized

characteristics: optimal spread of elastic force



Durchmesser diameter mm	Bandbreite band width mm	Bezeichnung description	Art.-Nr.
46	20	S 46/20	310 712
47	20	S 47/20	310 718
48	20	S 48/20	310 720
49	20	S 49/20	310 724
50	20	S 50/20	310 728
51	20	S 51/20	310 732
52	20	S 52/20	310 736
53	20	S 53/20	310 740
54	20	S 54/20	310 744
55	20	S 55/20	310 748
56	20	S 56/20	310 752
57	20	S 57/20	310 756
58	20	S 58/20	310 760
59	20	S 59/20	310 764
60	20	S 60/20	310 768
61	20	S 61/20	310 772
62	20	S 62/20	310 776
63	20	S 63/20	310 780
64	20	S 64/20	310 784
65	20	S 65/20	310 788
66	20	S 66/20	310 792
68	20	S 68/20	310 800
70	20	S 70/20	310 808
72	20	S 72/20	310 816
74	20	S 74/20	310 824
76	20	S 76/20	310 832
78	20	S 78/20	310 840
80	20	S 80/20	310 848
82	20	S 82/20	310 856
84	20	S 84/20	310 864
86	20	S 86/20	310 872
88	20	S 88/20	310 880
90	20	S 90/20	310 888
92	20	S 92/20	310 896
94	20	S 94/20	310 904
96	20	S 96/20	310 912
98	20	S 98/20	310 920
100	20	S 100/20	310 928
102	20	S 102/20	310 936
104	20	S 104/20	310 944
105	20	S 105/20	310 948
106	20	S 106/20	310 960
108	20	S 108/20	310 961
110	20	S 110/20	310 962
112	20	S 112/20	310 963
114	20	S 114/20	310 964
116	20	S 116/20	310 965
118	20	S 118/20	310 966
120	20	S 120/20	310 957

Schneckengewindeschellen Typ TORRO

worm thread clamps type TORRO



DIN 3017

Werkstoff: W2 = Band und Gehäuse rostfreier Stahl 1.4016, Schraube Stahl, verzinkt
(weitere Werkstoffe auf Anfrage)

Merkmale: patentierte asymmetrische Konstruktion, gleichmäßige Schlauchverpressung,
großer Spannungsbereich, Mehrbereichsschelle, schlauchschonend

DIN 3017

material: W2 = band and housing stainless steel 1.4016, screw steel, galvanized
(different material on request)

characteristics:

patented, asymmetrically construction, large clamping range, multi use clamp, hose sparing

Spannbereich clamping range mm	Bandbreite band width mm	SW	Bezeichnung description	Art.-Nr.
7-11	5		TORRO 7-11/5	311 114
11-19	5		TORRO 11-19/5	311 115
8-12	7,5	6	TORRO 8-12/7,5	311 116
12-18	7,5	6	TORRO 12-18/7,5	311 118
8-16	9	7	TORRO 8-16/9	311 100
12-22	9	7	TORRO 12-22/9	311 101
16-27	9	7	TORRO 16-27/9	311 102
20-32	9	7	TORRO 20-32/9	311 103
25-40	9	7	TORRO 25-40/9	311 105
30-45	9	7	TORRO 30-45/9	311 113
32-50	9	7	TORRO 32-50/9	311 106
40-60	9	7	TORRO 40-60/9	311 107
50-70	9	7	TORRO 50-70/9	311 108
60-80	9	7	TORRO 60-80/9	311 109
70-90	9	7	TORRO 70-90/9	311 110
80-100	9	7	TORRO 80-100/9	311 111
90-110	9	7	TORRO 90-110/9	311 112

Schneckengewindeschellen Typ TORRO S

worm thread clamps type TORRO S

DIN 3017

Werkstoff: W1 = alle Teile komplett Stahl, verzinkt

Merkmale: hohe Bandzugkraft, maximale Überdrehbarkeit, optimale Schlauchsicherung, optimale Dichtfunktion

DIN 3017

material: W1 = all items complete steel, galvanized

characteristics:

high band traction power, maximum overturning security, optimal hose sparing, optimal sealing function



Spannbereich clamping range mm	Bandbreite band width mm	SW	Bezeichnung description	Art.-Nr.
16-27	12	7	TORRO-S 16-27/12	311 152
20-32	12	7	TORRO-S 20-32/12	311 153
25-40	12	7	TORRO-S 25-40/12	311 155
30-45	12	7	TORRO-S 30-45/12	311 154
35-50	12	7	TORRO-S 35-50/12	311 156
40-60	12	7	TORRO-S 40-60/12	311 157
50-70	12	7	TORRO-S 50-70/12	311 158
60-80	12	7	TORRO-S 60-80/12	311 159
70-90	12	7	TORRO-S 70-90/12	311 160
80-100	12	7	TORRO-S 80-100/12	311 161
90-110	12	7	TORRO-S 90-110/12	311 162
100-120	12	7	TORRO-S 100-120/12	311 170
110-130	12	7	TORRO-S 110-130/12	311 163
120-140	12	7	TORRO-S 120-140/12	311 164
130-150	12	7	TORRO-S 130-150/12	311 165
140-160	12	7	TORRO-S 140-160/12	311 166
150-170	12	7	TORRO-S 150-170/12	311 167
160-180	12	7	TORRO-S 160-180/12	311 168
170-190	12	7	TORRO-S 170-190/12	311 169

Schneckengewindeschellen Typ TX

worm thread clamps type TX



DIN 3017

Werkstoff: W3 = Schnecke, Schraube, Gehäuse und Band: Stahl 1.4016 oder gleichwertiger korrosionsbeständiger Edelstahl, Schneckenschraube mit Sechskant mit Schlitz

Merkmale: hohe Bandzugkraft, hohes Zerstördrehmoment, optimale Schlauchschonung

DIN 3017

material: W3 = worm, thread, housing and band: steel 1.4016 or equivalent corrosion-resistant stainless steel, worm thread with hexagon with slot

characteristics: high band traction power, high destroying torque, optimal hose sparing

Spannbereich clamping range mm	Bandbreite band width mm	SW	Ref.-Nr.DC	Bezeichnung description	Art.-Nr.
12-22	12	8	000000000665	TX 12-22/12 W3	310 371
16-27	12	8	000000000666	TX 16-27/12 W3	310 372
20-32	12	8	000000000667	TX 20-32/12 W3	310 373
25-40	12	8	000000000668	TX 25-40/12 W3	310 374
30-45	12	8	000000000669	TX 30-45/12 W3	310 375
35-50	12	8	000000000670	TX 35-50/12 W3	310 376
40-60	12	8	000000000671	TX 40-60/12 W3	310 377
50-70	12	8	000000000672	TX 50-70/12 W3	310 378
60-80	12	8	000000000673	TX 60-80/12 W3	310 379
70-90	12	8	000000000674	TX 70-90/12 W3	310 380
80-100	12	8	000000000675	TX 80-100/12 W3	310 381
90-110	12	8	000000000645	TX 90-110/12 W3	310 382
100-120	12	8	000000000676	TX 100-120/12 W3	310 383
110-130	12	8	000000000644	TX 110-130/12 W3	310 384
120-140	12	8	000000000677	TX 120-140/12 W3	310 385
130-150	12	8	000000000678	TX 130-150/12 W3	310 386
140-160	12	8	000000000679	TX 140-160/12 W3	310 387
150-170	12	8	000000000680	TX 150-170/12 W3	310 388
160-180	12	8	000000000681	TX 160-180/12 W3	310 389
180-200	12	8		TX 180-200/12 W3	310 390
220-240	12	8		TX 220-240/12 W3	310 391

Schneckengewindeschellen Typ Pebra

worm thread clamps type Pebra



AERO BG/BGV

Werkstoff: W2 = Band, Sattel und Gehäuse aus Cr-Ni Stahl, Schraube Stahl verzinkt

material: W2 = band, saddle and housing Cr-Ni steel, screw steel galvanized

Spannbereich clamping range mm	Bandbreite band width mm	SW	Bezeichnung description	Art.-Nr.
12-22	14,3	8	AERO BG 12-22	310 540
16-27	14,3	8	AERO BG 16-27	310 542
20-32	14,3	8	AERO BG 20-32	310 543
25-40	14,3	8	AERO BGV 25-40	310 545
30-45	14,3	8	AERO BGV 30-45	310 544
35-50	14,3	8	AERO BGV 35-50	310 546
40-60	14,3	8	AERO BGV 40-60	310 548
50-70	14,3	8	AERO BGV 50-70	310 549
60-80	14,3	8	AERO BGV 60-80	310 551
70-90	14,3	8	AERO BGV 70-90	310 552
80-100	14,3	8	AERO BGV 80-100	310 554
90-110	14,3	8	AERO BGV 90-110	310 556

Schneckengewindeschellen Typ Pebra

worm thread clamps type Pebra

AERO BG/BGV

Werkstoff: W2 = Band, Sattel und Gehäuse aus Cr-Ni Stahl, Schraube Stahl verzinkt

material: W2 = band, saddle and housing Cr-Ni steel, screw steel galvanized

Spannbereich clamping range mm	Bandbreite band width mm	SW	Bezeichnung description	Art.-Nr.
100-120	14,3	8	AERO BGV 100-120	310 550
110-130	14,3	8	AERO BGV 110-130	310 557
120-140	14,3	8	AERO BGV 120-140	310 553
130-150	14,3	8	AERO BGV 130-150	310 558
140-160	14,3	8	AERO BGV 140-160	310 555
150-170	14,3	8	AERO BGV 150-170	310 559



Schneckengewindeschellen Typ Pebra

worm thread clamps type Pebra

AERO BG-C/BGV-C

Werkstoff: W4 = Band, Sattel, Gehäuse und Schraube aus Cr-Ni Stahl, Schraube Stahl verzinkt

material: W4 = band, saddle, housing and screw Cr-Ni steel, screw steel galvanized

Spannbereich clamping range mm	Bandbreite band width mm	SW	Bezeichnung description	Art.-Nr.
12-22	14,3	8	AERO BG-C 12-22	310 560
16-27	14,3	8	AERO BG-C 16-27	310 562
20-32	14,3	8	AERO BG-C 20-32	310 563
25-40	14,3	8	AERO BGV-C 25-40	310 565
30-45	14,3	8	AERO BGV-C 30-45	310 564
35-50	14,3	8	AERO BGV-C 35-50	310 566
40-60	14,3	8	AERO BGV-C 40-60	310 568
50-70	14,3	8	AERO BGV-C 50-70	310 569
60-80	14,3	8	AERO BGV-C 60-80	310 571
70-90	14,3	8	AERO BGV-C 70-90	310 572
80-100	14,3	8	AERO BGV-C 80-100	310 574
90-110	14,3	8	AERO BGV-C 90-110	310 576
100-120	14,3	8	AERO BGV-C 100-120	310 570
110-130	14,3	8	AERO BGV-C 110-130	310 577
120-140	14,3	8	AERO BGV-C 120-140	310 573
130-150	14,3	8	AERO BGV-C 130-150	310 575
140-160	14,3	8	AERO BGV-C 140-160	310 578
150-170	14,3	8	AERO BGV-C 150-170	310 579



Schneckengewindeschellen Typ Pebra

worm thread clamps type Pebra

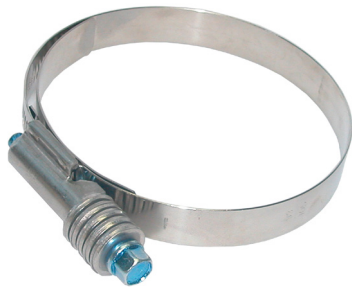

AERO HKFK - mit Tellerfeder

Werkstoff: W2 = Band, Sattel und Gehäuse aus Cr-Ni Stahl, Schraube und Tellerfederpaket
Stahl verzinkt

AERO HKFK - with disc spring

material: W2 = band, saddle and housing Cr-Ni steel, screw and disc spring package steel
galvanized

Spannbereich clamping range mm	Bandbreite band width mm	SW	Bezeichnung description	Art.-Nr.
12-22	14,3	8	AERO HKFK 12-22	310 410
16-27	14,3	8	AERO HKFK 16-27	310 411
20-32	14,3	8	AERO HKFK 20-32	310 412
25-40	14,3	8	AERO HKFK 25-40	310 413
30-45	14,3	8	AERO HKFK 30-45	310 414
35-50	14,3	8	AERO HKFK 35-50	310 415
40-60	14,3	8	AERO HKFK 40-60	310 416
50-70	14,3	8	AERO HKFK 50-70	310 417
60-80	14,3	8	AERO HKFK 60-80	310 418
70-90	14,3	8	AERO HKFK 70-90	310 419

Schneckengewindeschellen Typ Pebra

worm thread clamps type Pebra



AERO HKFK - mit Tellerfeder

Werkstoff: W4 = Band, Sattel, Gehäuse, Schraube und Tellerfederpaket aus Cr-Ni Stahl

AERO HKFK - with disc spring

material: W2 = band, saddle and housing, screw and disc spring package Cr-Ni steel

Spannbereich clamping range mm	Bandbreite band width mm	SW	Bezeichnung description	Art.-Nr.
12-22	14,3	8	AERO-HKFK-C 12 - 22	310 430
16-27	14,3	8	AERO-HKFK-C 16 - 27	310 431
20-32	14,3	8	AERO-HKFK-C 20 - 32	310 432
25-40	14,3	8	AERO-HKFK-C 25 - 40	310 433
30-45	14,3	8	AERO-HKFK-C 30 - 45	310 434
35-50	14,3	8	AERO-HKFK-C 35 - 50	310 435
40-60	14,3	8	AERO-HKFK-C 40 - 60	310 436
50-70	14,3	8	AERO-HKFK-C 50 - 70	310 437
60-80	14,3	8	AERO-HKFK-C 60 - 80	310 438
70-90	14,3	8	AERO-HKFK-C 70 - 90	310 439
80-100	14,3	8	AERO-HKFK-C 80 - 100	310 440
90-110	14,3	8	AERO-HKFK-C 90 - 110	310 441
100-120	14,3	8	AERO-HKFK-C 100 - 120	310 442
110-130	14,3	8	AERO-HKFK-C 110 - 130	310 443
120-140	14,3	8	AERO-HKFK-C 120 - 140	310 444
130-150	14,3	8	AERO-HKFK-C 130 - 150	310 445
140-160	14,3	8	AERO-HKFK-C 140 - 160	310 446

Schneckengewindeschellen Typ GBS

worm thread clamps type GBS

DIN 3017

Werkstoff: W2 = Band aus Chromstahl 1.4510/1.4511, Verschlusssteile Kohlenstoff-Stahl, verzinkt/
chromatiert

material: W2 = band chrome plated steel 1.4510/1.4511, plugs carbon-steel, galvanized/chromated

Spannbereich clamp range mm	Bandbreite band width mm	Materialstärke material strength mm	Gewinde thread	SW	Bezeichnung description	Art.-Nr.
17-19	18	0,6	M 6	8	GBS 18/18 SK	311 699
19-21	18	0,6	M 6	8	GBS 20/18 SK	311 700
21-23	18	0,6	M 6	8	GBS 22/18 SK	311 701
23-25	18	0,6	M 6	8	GBS 24/18 SK	311 702
25-27	18	0,6	M 6	8	GBS 26/18 SK	311 703
27-29	18	0,6	M 6	8	GBS 28/18 SK	311 708
29-31	18	0,6	M 6	8	GBS 30/18 SK	311 704
31-34	18	0,6	M 6	8	GBS 33/18 SK	311 705
34-37	18	0,6	M 6	8	GBS 36/18 SK	311 709
37-40	18	0,6	M 6	8	GBS 39/18 SK	311 706
40-43	18	0,6	M 6	8	GBS 42/18 SK	311 707
43-47	20	0,8	M 7	10	GBS 45/20 SK	311 711
47-51	20	0,8	M 7	10	GBS 49/20 SK	311 712
51-55	20	0,8	M 7	10	GBS 53/20 SK	311 713
55-59	20	0,8	M 7	10	GBS 57/20 SK	311 714
59-63	20	0,8	M 7	10	GBS 61/20 SK	311 715
63-68	20	0,8	M 7	10	GBS 66/20 SK	311 716
68-73	25	1,0	M 8	13	GBS 71/25 SK	311 741
73-79	25	1,0	M 8	13	GBS 76/25 SK	311 742
79-85	25	1,0	M 8	13	GBS 82/25 SK	311 743
85-91	25	1,0	M 8	13	GBS 88/25 SK	311 744
91-97	25	1,0	M 8	13	GBS 94/25 SK	311 745
97-104	25	1,0	M 8	13	GBS 101/25 SK	311 746
104-112	25	1,0	M 8	13	GBS 108/25 SK	311 747
112-121	25	1,0	M 8	13	GBS 117/25 SK	311 748
121-130	25	1,0	M 8	13	GBS 126/25 SK	311 749
130-140	30	1,0	M 10	17	GBS 135/30 SK	311 777
140-150	30	1,0	M 10	17	GBS 145/30 SK	311 778
150-162	30	1,0	M 10	17	GBS 156/30 SK	311 779
162-174	30	1,0	M 10	17	GBS 168/30 SK	311 780
174-187	30	1,0	M 10	17	GBS 181/30 SK	311 781
187-200	30	1,0	M 10	17	GBS 194/30 SK	311 782
200-213	30	1,0	M 10	17	GBS 207/30 SK	311 783
213-226	30	1,0	M 10	17	GBS 220/30 SK	311 784
226-239	30	1,0	M 10	17	GBS 233/30 SK	311 785
239-252	30	1,0	M 10	17	GBS 246/30 SK	311 786



Schlauchschellen Typ Cobra

hose clamps type Cobra



schraublos

Werkstoff: rostfreier Chromnickelstahl

without screwing

material: chromium nickel steel stainless steel

ND/mm	Ø/mm	Bandbreite/mm band width/mm	Farbkennung colour identification	Bezeichnung description	Art.-Nr.
7,5	8,0-9,0	7	weiß/white	COBRA 7,5/7	311 651
8	8,5-9,5	7	gelb/yellow	COBRA 8/7	311 652
8,5	9,0-10,0	7	grün/green	COBRA 8,5/7	311 653
9	9,5-10,5	7	violett/violet	COBRA 9/7	311 654
9,5	10,0-11,0	7	schwarz/black	COBRA 9,5/7	311 655
10	10,5-11,5	7	weiß/white	COBRA 10/7	311 656
10,5	11,0-12,0	7	gelb/yellow	COBRA 10,5/7	311 657
11	11,5-12,5	7	grün/green	COBRA 11/7	311 658
11,5	12,0-13,0	7	violett/violet	COBRA 11,5/7	311 659
12	12,5-14,0	8	schwarz/black	COBRA 12/8	311 661
13	13,5-15,0	8	gelb/yellow	COBRA 13/8	311 662
14	14,5-16,0	8	violett/violet	COBRA 14/8	311 663
15	15,5-17,0	8	weiß/white	COBRA 15/8	311 664
16	16,5-18,0	8	grün/green	COBRA 16/8	311 665
17	17,5-19,0	8	schwarz/black	COBRA 17/8	311 666
18	18,5-20,0	8	gelb/yellow	COBRA 18/8	311 667
19	19,5-21,0	8	violett/violet	COBRA 19/8	311 668
21	21,5-23,0	8	grün/green	COBRA 21/8	311 670

Cobra Handzangen

cobra hand pliers



zur Montage der Cobra-Schlauchschellen

Diese Handzange ermöglicht exakte Montagen und beschädigungsfreie Demontagen. Die Spitzen des Zangenkopfes greifen sicher in die Werkzeugangriffspunkte der Schelle. Das integrierte, leichtgängige Federelement hält die Zange stets offen und erlaubt somit ein problemloses, zügiges Arbeiten.

for the assemble of the Cobra hose clamps

This hand pliers makes accurate assemblies and damage-free disassemblies possible. The points of the pliers head reach reliably into the tool pints of the clip. The integrated, low-friction spring element always keeps the pliers open and permits thus a problem-free, brisk working.

Bezeichnung description	Art.-Nr.
Cobra-Handzange	311 640

Rohrschellen Typ RSGU 1. pipe clamps type RSGU 1.

DIN 3016

Werkstoff: W1 = Stahl, verzinkt mit Gummiprofil

Merkmale: Erfüllen die hohen Anforderungen der Automobilindustrie;
große Typenauswahl

material: W1 = steel, galvanized with rubber extrusion

characteristics: fulfill the high requirements of the automotive industry;
large type selection

Rohr-Ø pipe-Ø mm	Bandbreite band width mm	Bohrung-Ø bore-Ø mm	Bezeichnung description	Art.-Nr.
4	9	4,3	RSGU 1. 4/9	310 010
5	9	4,3	RSGU 1. 5/9	310 020
6	12	5,3	RSGU 1. 6/12	310 031
6	15	6,4	RSGU 1. 6/15	310 032
8	9	4,3	RSGU 1. 8/9	310 040
8	12	5,3	RSGU 1. 8/12	310 041
8	15	6,4	RSGU 1. 8/15	310 042
9	12	5,3	RSGU 1. 9/12	310 051
9	15	6,4	RSGU 1. 9/15	310 052
10	9	4,3	RSGU 1. 10/9	310 060
10	12	5,3	RSGU 1. 10/12	310 061
10	15	6,4	RSGU 1. 10/15	310 062
10	20	8,4	RSGU 1. 10/20	310 063
12	12	5,3	RSGU 1. 12/12	310 071
12	15	6,4	RSGU 1. 12/15	310 072
12	20	8,4	RSGU 1. 12/20	310 073
13	12	5,3	RSGU 1. 13/12	310 076
13	15	6,4	RSGU 1. 13/15	310 077
13	20	8,4	RSGU 1. 13/20	310 078
14	12	5,3	RSGU 1. 14/12	310 081
14	15	6,4	RSGU 1. 14/15	310 082
14	20	8,4	RSGU 1. 14/20	310 083
15	12	5,3	RSGU 1. 15/12	310 091
15	15	6,4	RSGU 1. 15/15	310 092
15	20	8,4	RSGU 1. 15/20	310 093
15	25	10,4	RSGU 1. 15/25	310 094
16	12	5,3	RSGU 1. 16/12	310 101
16	15	6,4	RSGU 1. 16/15	310 102
16	20	8,4	RSGU 1. 16/20	310 103
18	12	5,3	RSGU 1. 18/12	310 111
18	15	6,4	RSGU 1. 18/15	310 112
18	20	8,4	RSGU 1. 18/20	310 113
19	12	5,3	RSGU 1. 19/12	310 116
19	15	6,4	RSGU 1. 19/15	310 117
19	20	8,4	RSGU 1. 19/20	310 118
20	12	5,3	RSGU 1. 20/12	310 121
20	15	6,4	RSGU 1. 20/15	310 122
20	20	8,4	RSGU 1. 20/20	310 123
21	12	5,3	RSGU 1. 21/12	310 124
21	15	6,4	RSGU 1. 21/15	310 125
22	9	4,3	RSGU 1. 22/9	310 130
22	12	5,3	RSGU 1. 22/12	310 131
22	15	6,4	RSGU 1. 22/15	310 132
22	20	8,4	RSGU 1. 22/20	310 133
22	25	10,4	RSGU 1. 22/25	310 134



Rohrschellen Typ RSGU 1. pipe clamps type RSGU 1.



DIN 3016

Werkstoff: W1 = Stahl, verzinkt mit Gummiprofil

Merkmale: Erfüllen die hohen Anforderungen der Automobilindustrie; große Typenauswahl

material: W1 = steel, galvanized with rubber extrusion

characteristics: fulfill the high requirements of the automotive industry; large type selection

Rohr-Ø pipe-Ø mm	Bandbreite band width mm	Bohrung-Ø bore-Ø mm	Bezeichnung description	Art.-Nr.
23	15	6,4	RSGU 1. 23/15	310 137
23	20	8,4	RSGU 1. 23/20	310 138
24	15	6,4	RSGU 1. 24/15	310 142
24	20	8,4	RSGU 1. 24/20	310 143
25	15	6,4	RSGU 1. 25/15	310 152
25	20	8,4	RSGU 1. 25/20	310 153
25	25	10,4	RSGU 1. 25/25	310 154
26	15	6,4	RSGU 1. 26/15	310 162
26	20	8,4	RSGU 1. 26/20	310 163
28	15	6,4	RSGU 1. 28/15	310 172
28	20	8,4	RSGU 1. 28/20	310 173
28	25	10,4	RSGU 1. 28/25	310 174
30	15	6,4	RSGU 1. 30/15	310 182
30	20	8,4	RSGU 1. 30/20	310 183
31	20	8,4	RSGU 1. 31/20	310 180
32	15	6,4	RSGU 1. 32/15	310 185
32	20	8,4	RSGU 1. 32/20	310 186
34	15	6,4	RSGU 1. 34/15	310 187
34	20	8,4	RSGU 1. 34/20	310 188
35	15	6,4	RSGU 1. 35/15	310 197
35	20	8,4	RSGU 1. 35/20	310 189
35	25	10,4	RSGU 1. 35/25	310 190
36	20	8,4	RSGU 1. 36/20	310 179
38	20	8,4	RSGU 1. 38/20	310 191
40	20	8,4	RSGU 1. 40/20	310 193
45	20	8,4	RSGU 1. 45/20	310 195
48	25	10,4	RSGU 1. 48/25	310 181
50	20	8,4	RSGU 1. 50/20	310 196
50	25	10,4	RSGU 1. 50/25	310 198
55	20	8,4	RSGU 1. 55/20	310 194
60	20	8,4	RSGU 1. 60/20	310 199

Befestigungsschellen Typ BSN/BSS zweilaschig fastening clamps Type BSN/BSS two brackets

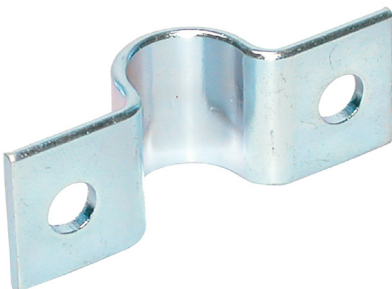

DIN 1593

Werkstoff: Stahl, verzinkt mit einseitiger Befestigung

material: steel, galvanized with one sided mounted

Rohr-Ø pipe-Ø mm	Bandbreite band width mm	Materialstärke material strength mm	Bohrung-Ø bore-Ø mm	Bezeichnung description	Art.-Nr.
15	20	2	7	BSN 15X20X2 ZWL	310 221
19	25	3	9	BSS 19X25X3 ZWL	310 222
23	25	3	9	BSS 23X25X3 ZWL	310 223

Befestigungsschellen fastening clamps

DIN 72571

Werkstoff: Stahl, verzinkt mit einseitiger Befestigung

material: steel, galvanized with one sided mounted



Rohr-Ø pipe-Ø mm	Bandbreite band width mm	Materialstärke material strength mm	Bohrung-Ø bore-Ø mm	Bezeichnung description	Art.-Nr.
4	10	1	4,8	72571/4	310 230
5	10	1	4,8	72571/5	310 231
6	10	1	4,8	72571/6	310 232
7	10	1	4,8	72571/7	310 233
8	10	1	4,8	72571/8	310 234
9	10	1	4,8	72571/9	310 235
10	10	1	4,8	72571/10	310 236
11	12	1,5	5,8	72571/11	310 244
12	12	1,5	5,8	72571/12	310 237
15	12	1,5	5,8	72571/15	310 238
16	12	1,5	5,8	72571/16	310 243
18	12	1,5	7,0	72571/18	310 239
20	12	1,5	7,0	72571/20	310 240
22	12	1,5	7,0	72571/22	310 241
24	12	1,5	7,0	72571/24	310 242

Befestigungsschellen Typ BSN/BSS fastening clamps type BSN/BSS

DIN 1592

Werkstoff: Stahl, verzinkt mit einseitiger Befestigung

material: steel, galvanized with one sided mounted



Rohr-Ø pipe-Ø mm	Bandbreite band width mm	Materialstärke material strength mm	Bohrung-Ø bore-Ø mm	Bezeichnung description	Art.-Nr.
8	20	2	7	BSN 8X20X2	310 200
9	20	2	7	BSN 9X20X2	310 201
10	20	2	7	BSN 10X20X2	310 205
12	20	2	7	BSN 12X20X2	310 207
13	20	2	7	BSN 13X20X2	310 202
15	20	2	7	BSN 15X20X2	310 203
18	20	2	7	BSN 18X20X2	310 206
19	20	2	7	BSN 19X20X2	310 204
15	25	3	9	BSS 15X25X3	310 210
18	25	3	9	BSS 18X25X3	310 218
19	25	3	9	BSS 19X25X3	310 211
20	25	3	9	BSS 20X25X3	310 219
22	25	3	9	BSS 22X25X3	310 220
23	25	3	9	BSS 23X25X3	310 212

Kabelbinder Typ P

cable ties type P

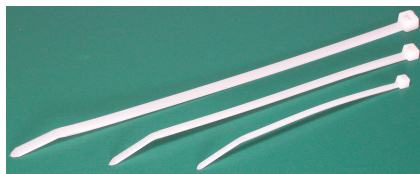

Farbe: weiß

Werkstoff: Polyamid 6.6

Temperaturbereich: -40° C bis +85° C

Entflammbarkeit gemäß UL94V-2

Beständigkeit: gute Witterungsbeständigkeit, hervorragende Beständigkeit gegen Öle, Fette, Schmierstoffe, aliphatische und aromatische Kohlenwasserstoffe

color: white

material: polyamid 6.6

temperature range: -40° C to +85° C

inflammability in accordance with UL94V-2

stability: good weather proofness, excellent stability against oil, grease, lubricants, aliphatic and aromatic hydrocarbons

Länge length mm	Breite width mm	Art.-Nr.
99	2,5	311 400
142	3,6	311 401
188	4,8	311 402
292	4,8	311 403
211	7,6	311 405
368	7,6	311 404

Kabelbinder Typ P

cable ties type P

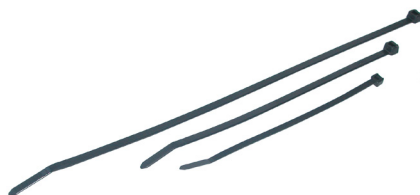

Farbe: schwarz

Werkstoff: Polyamid 6.6 -UV-stabilisiert-

Temperaturbereich: -40° C bis +85° C

Entflammbarkeit gemäß UL94V-2 - UL94HB

Beständigkeit: sehr gute Witterungsbeständigkeit, hervorragende Beständigkeit gegen Öle, Fette, Schmierstoffe, aliphatische und aromatische Kohlenwasserstoffe

color: black

material: polyamid 6.6 -UV-stabilized-

temperature range: -40° C to +85° C

inflammability in accordance with UL94V-2 - UL94HB

stability: extreme good weather proofness, excellent stability against oil, grease, lubricants, aliphatic and aromatic hydrocarbons

Länge length mm	Breite width mm	Art.-Nr.
142	3,6	311 411
188	4,8	311 412
292	4,8	311 413
368	4,8	311 417
368	7,6	311 414

Farbe: schwarz - lösbar

color: black - detachable

Länge length mm	Breite width mm	Ref.-Nr. DC	Art.-Nr.
172	4,6	-	311 422
280	4,6	002 997 2490	311 423
376	7,6	002 997 5890	311 424

Kabelbinder Typ S

cable ties type S

Farbe: weiß

Werkstoff: Polyamid 6.6

Temperaturbereich: -40° C bis +85° C

Entflammbarkeit gemäß UL94V-2

Beständigkeit: gute Witterungsbeständigkeit, bedingt UV-beständig, Beständigkeit gegen Öle, Fette, und Kfz-Treibstoffe, Vorsicht bei Säuren und Chemikalien

color: white

material: polyamid 6.6

temperature range: -40° C to +85° C

inflammability in accordance with UL94V-2

stability: good weather proofness, partially UV-resistant, resistance against oil, grease and fuels, caution with acids and chemicals

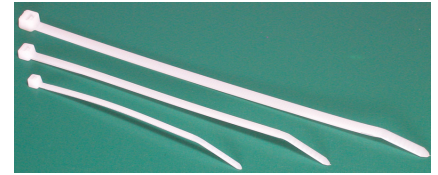

Länge length mm	Breite width mm	Art.-Nr.
100	2,5	311 430
140	3,6	311 431
200	4,8	311 432
300	4,8	311 433
292	7,6	311 435
368	7,6	311 434

Kabelbinder Typ S

cable ties type S

Farbe: schwarz

Werkstoff: Polyamid 6.6

Temperaturbereich: -40° C bis +85° C

Entflammbarkeit gemäß UL94V-2

Beständigkeit: gute Witterungsbeständigkeit, bedingt UV-beständig, Beständigkeit gegen Öle, Fette, und Kfz-Treibstoffe, Vorsicht bei Säuren und Chemikalien

color: black

material: polyamid 6.6

temperature range: -40° C to +85° C

inflammability in accordance with UL94V-2

stability: good weather proofness, partially UV-resistant, resistance against oil, grease and fuels, caution with acids and chemicals

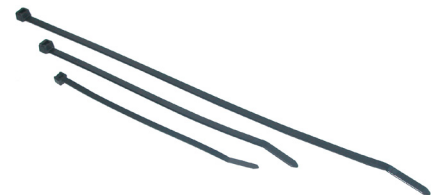

Länge length mm	Breite width mm	Art.-Nr.
100	2,5	311 440
140	3,6	311 441
200	4,8	311 442
300	4,8	311 443
368	4,8	311 447
368	7,6	311 444
540	8,0	311 446

Kabelbinder Typ S - farbig

cablE ties typE S - colorEd

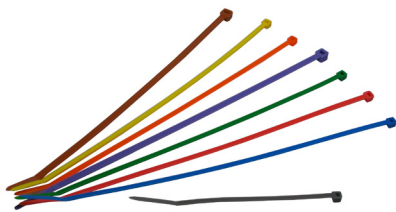

Werkstoff: Polyamid 6.6

Temperaturbereich: -40° C bis +85° C

Entflammbarkeit gemäß UL94V-2

Beständigkeit: gute Witterungsbeständigkeit, bedingt UV-beständig, Beständigkeit gegen Öle, Fette, und Kfz-Treibstoffe, Vorsicht bei Säuren und Chemikalien

material: polyamid 6.6

temperature range: -40° C to +85° C

inflammability in accordance with UL94V-2

stability: good weather proofness, partially UV-resistant, resistance against oil, grease and fuels, caution with acids and chemicals

Länge length mm	Breite width mm	Farbe colour	Art.-Nr.
100	2,5	blau/blue	311 470
100	2,5	rot/red	311 471
100	2,5	gelb/yellow	311 472
100	2,5	grün/green	311 473
100	2,5	braun/brown	311 474
100	2,5	grau/grey	311 475
100	2,5	orange/orange	311 476
100	2,5	violett/violet	311 477
200	3,6	blau/blue	311 480
200	3,6	rot/red	311 481
200	3,6	gelb/yellow	311 482
200	3,6	grün/green	311 483
200	3,6	braun/brown	311 484
200	3,6	grau/grey	311 485
200	3,6	orange/orange	311 486
200	3,6	violett/violet	311 487

Gelenktechnik

Joint technology

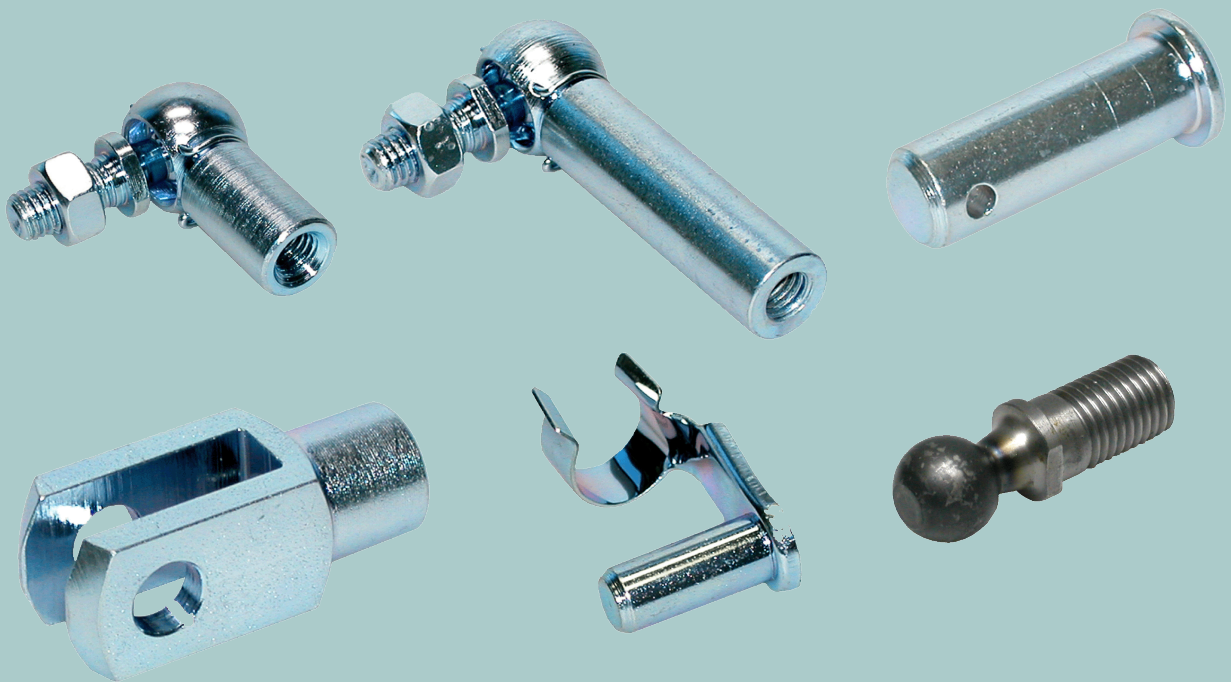

Die Längenangabe bei Winkelgelenken und Kugelpfannen wird von Mitte Kugelpfanne bis Ende Gewinde gemessen.
The length specification by angle joints and ball sockets are measured by center ball pin to end thread.



Die Schlitzlänge bei Gabelgelenken und Gabelköpfen wird von Mitte Bolzenbohrung bis Ende Schlitz gemessen.
The slot length with forked joints and fork heads are measured by center pin drilling to end slot.

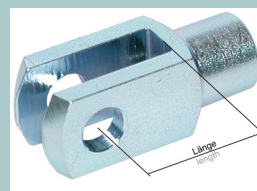

Winkelgelenke

angle joints

Kugelpfannen

ball sockets

Kugelzapfen und Zubehör

ball pins and accessories

Gabelgelenke

fork joints

Gabelköpfe

fork heads

Gabelgelenkbolzen und Zubehör

fork joints and accessories

Winkelgelenke angle joints



DIN 71802

Werkstoff: Stahl, verzinkt

Ausführung CS mit Gewindezapfen und Schlüsselfläche, Sechskantmutter und Sicherungsbügel

material: steel, galvanized

construction CS with spigots and flat, hexagon nut and locking strap

Gewinde Pfanne thread socket	Gewinde Zapfen thread pin	Kugel-Ø ball-Ø mm	Länge length mm	DIN	Bezeichnung description	Art.-Nr.
M 5X0,80	M 5X0,80	8	22	CS 8	WG 5 S	220 125
M 6X1,00	M 6X1,00	10	25	CS 10	WG 6 S	220 126
M 8X1,25	M 8X1,25	13	30	CS 13	WG 8 S	220 128
M 10X1,50	M 10X1,50	16	35	CS 16	WG 10 S	220 130
M 12X1,75	M 12X1,75	16	35	CS 16	WG 12 S	220 132
M 14X1,50	M 14X1,50	19	45	CS 19	WG 14 S	220 134
M 14X2,00	M 14X2,00	19	45	CS 19	WG 14X2 S	220 135
M 16X2,00	M 16X2,00	19	45	CS 19	WG 16 S	220 136

Winkelgelenke angle joints



DIN 71802 mit Linksgewinde

Werkstoff: Stahl, verzinkt

Ausführung CS mit Gewindezapfen und Schlüsselfläche, Sechskantmutter und Sicherungsbügel

DIN 71802 with left-hand thread

material: steel, galvanized

construction CS with spigots and flat, hexagon nut and locking strap

Gewinde Pfanne thread socket	Gewinde Zapfen thread pin	Kugel-Ø ball-Ø mm	Länge length mm	Bezeichnung description	Art.-Nr.
M 5X0,80 links	M 5X0,80	8	22	WG 5 S links	220 225
M 6X1,00 links	M 6X1,00	10	25	WG 6 S links	220 226
M 8X1,25 links	M 8X1,25	13	30	WG 8 S links	220 228
M 10X1,50 links	M 10X1,50	16	35	WG 10 S links	220 230
M 12X1,75 links	M 12X1,75	16	35	WG 12 S links	220 232
M 14X2,00 links	M 14X2,00	19	45	WG 14 S links	220 234
M 16X2,00 links	M 16X2,00	19	45	WG 16 S links	220 236

Winkelgelenke DC angle joints DC



für Daimler Nutzfahrzeuge

Werkstoff: Stahl, verzinkt/Nylon

for Daimler motor vehicles

material: steel, galvanized/nylon

Gewinde Pfanne thread socket	Gewinde Zapfen thread pin	Kugel-Ø ball-Ø mm	Länge length mm	Bezeichnung description	Art.-Nr.
M 10X1,50	M 10X1,50	16	45	WG 10 S lang	220 156
M 8X1,25	M 8X1,25	13	56	WG 8 DB Nylon	220 157

Winkelgelenke MAN angle joints MAN

für MAN Nutzfahrzeuge

Werkstoff: Stahl, verzinkt

for MAN motor vehicles

material: steel, galvanized

Gewinde Pfanne thread socket	Gewinde Zapfen thread pin	Kugel-Ø ball-Ø mm	Länge length mm	Bezeichnung description	Art.-Nr.
M 6X1,00	M 6X1,00	10	40	WG 6 S MAN	220 152
M 8X1,25	M 8X1,25	13	45	WG 8 S MAN	220 153



Kugelpfannen ball sockets

DIN 71805, Form B

Werkstoff: Stahl, verzinkt

Ausführung B mit Nut für Sicherungsbügel passend für Kugelzapfen DIN 71803, Ausführung AS und CS

material: Steel, galvanized

construction B with groove suitable for locking straps, for ball pins DIN 71803, construction AS and CS

Gewinde thread	für Kugel-Ø/mm for ball-Ø/mm	Länge/mm length/mm	DIN	Bezeichnung description	Art.-Nr.
M 5X0,80	8	22	B 8	PF 5 S	220 505
M 6X1,00	10	25	B 10	PF 6 S	220 506
M 8X1,25	13	30	B 13	PF 8 S	220 508
M 10X1,50	16	35	B 16	PF 10 S	220 510
M 12X1,75	16	35	B 16	PF 12 S	220 512
M 14X1,50	19	45	B 19	PF 14 S	220 514
M 14X2,00	19	45	B 19	PF 14X2 S	220 515
M 16X2,00	19	45	B 19	PF 16 S	220 516



Kugelpfannen DC ball sockets DC

für Daimler Nutzfahrzeuge

Werkstoff: Stahl, verzinkt

Ausführung B mit Nut für Sicherungsbügel passend für Kugelzapfen DIN 71803, Ausführung AS und CS

for Daimler motor vehicles

material: steel, galvanized

construction B with groove suitable for locking straps for ball pins DIN 71803, construction AS and CS

Gewinde thread	für Kugel-Ø/mm for ball-Ø/mm	Länge/mm length/mm	Bezeichnung description	Art.-Nr.
M 10X1,50	16	45	PF 10 S lang	220 555



Kugelfannen MAN

ball sockets MAN



für MAN Nutzfahrzeuge

Werkstoff: Stahl, verzinkt

Ausführung B mit Nut für Sicherungsbügel passend für Kugelzapfen DIN 71803, Ausführung AS und CS

for MAN motor vehicles

material: steel, galvanized

construction B with groove suitable for locking straps, for ball pins DIN 71803, construction AS and CS

Gewinde thread	für Kugel-Ø/mm for ball-Ø/mm	Länge/mm length/mm	Bezeichnung description	Art.-Nr.
M 6X1,00	10	40	PF 6 S MAN	220 550
M 8X1,25	13	45	PF 8 S MAN	220 551

Kugelzapfen

ball pins



DIN 71802

Werkstoff: Stahl, verzinkt

mit Gewindezapfen und Schlüsselfläche, passend für Kugelfannen DIN 71805

material: steel, galvanized

with spigots and flat, suitable for ball cups DIN 71805

Gewinde thread	für Kugel-Ø/mm for ball-Ø/mm	DIN	Bezeichnung description	Art.-Nr.
M 5X0,80	8	C 8	BO 5	220 705
M 6X1,00	10	C 10	BO 6	220 706
M 8X1,25	13	C 13	BO 8	220 708
M 10X1,50	16	C 16	BO 10	220 710
M 12X1,50	16	C 16	BO 12	220 712
M 14X1,50	19	C 19	BO 14	220 714
M 14X2,00	19	C 19	BO 14X2	220 715
M 16X2,00	19	C 19	BO 16	220 716

Sicherungsbügel für Winkelgelenke

locking straps for angle joints



DIN 71805

Werkstoff: Stahl, verzinkt

material: steel, galvanized

Gewinde thread	DIN	Bezeichnung description	Art.-Nr.
WG 5	CS 8	SB 5	220 805
WG 6	CS 10	SB 6	220 806
WG 8	CS 13	SB 8	220 808
WG 10+12	CS 16	SB 10/12	220 810
WG 14+16	CS 19	SB 14/16	220 814

Dichtkappen für Winkelgelenke

sealing caps for angle joints

Werkstoff: Gummi CR (Neoprene)

Temperaturbereich: -30° bis +110° C (kurzfristig bis +140° C)

Anwendung: Staub- und Spritzwasserschutz

material: rubber CR (Neoprene)

temperature range: -30° to +110° C (temporary +140° C)

application: dust and splash-water protection



für Winkelgelenke for angle joint	DIN	Bezeichnung description	Art.-Nr.
WG 5	CS 8	DK 8	220 855
WG 6	CS 10	DK 10	220 856
WG 8	CS 13	DK 13	220 858
WG 10+12	CS 16	Dk 16	220 860

Sechskantmuttern

hexagon nuts

DIN 934

Werkstoff: Stahl, verzinkt, Festigkeitsklasse 6

material: steel, galvanized, strength class 6



Gewinde thread	Bezeichnung description	Art.-Nr.
M 5X0,80	SKM 5	220 905
M 6X1,00	SKM 6	220 906
M 8X1,25	SKM 8	220 908
M 10X1,50	SKM 10	220 910
M 12X1,75	SKM 12	220 912
M 14X1,50	SKM 14X1,5	220 914

Gabelgelenke

fork joints

DIN 71751

Werkstoff: Stahl, verzinkt

Ausführung A, mit Bolzen, Scheibe und Splint

material: steel, galvanized

construction A, with pin, disk and split pin

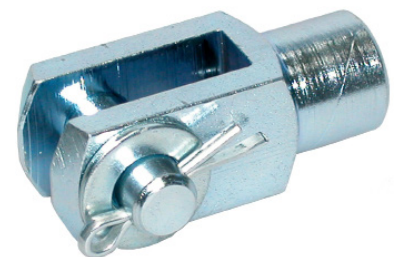

Bohrung-Ø/mm bore-Ø/mm	Schlitzlänge/mm slot length/mm	Schlitzbreite/mm slot wide/mm	Gewinde thread	Bezeichnung description	Art.-Nr.
5	10	5	M 5X0,80	GG 5/10	222 005
5	20	5	M 5X0,80	GG 5/20	222 105
6	12	6	M 6X1,00	GG 6/12	222 006
6	24	6	M 6X1,00	GG 6/24	222 106
8	16	8	M 8X1,25	GG 8/16	222 008
8	32	8	M 8X1,25	GG 8/32	222 108
10	20	10	M 10X1,5	GG 10/20	222 010
10	40	10	M 10X1,5	GG 10/40	222 110
12	24	12	M 12X1,75	GG 12/24	222 012
12	48	12	M 12X1,75	GG 12/48	222 112
14	28	14	M 14X2	GG 14/48	222 014
14	56	14	M 14X2	GG 14/56	222 114
16	32	16	M 16X2	GG 16/32	222 016
16	64	16	M 16X2	GG 16/64	222 116

Gabelköpfe fork heads

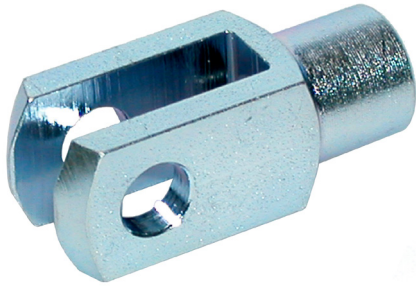

DIN 71752

Werkstoff: Stahl, verzinkt

Ausführung G, ohne Bolzen, Scheibe und Splint

material: steel, galvanized

construction G, without pin, disk and split pin

Bohrung-Ø/mm bore-Ø/mm	Schlitzlänge/mm slot length/mm	Schlitzbreite/mm slot wide/mm	Gewinde thread	Bezeichnung description	Art.-Nr.
5	10	5	M 5X0,80	GK 5/10	222 205
5	20	5	M 5X0,80	GK 5/20	222 305
6	12	6	M 6X1,00	GK 6/12	222 206
6	24	6	M 6X1,00	GK 6/24	222 306
8	16	8	M 8X1,25	GK 8/16	222 208
8	32	8	M 8X1,25	GK 8/32	222 308
10	20	10	M 10X1,5	GK 10/20	222 210
10	40	10	M 10X1,5	GK 10/40	222 310
12	24	12	M 12X1,75	GK 12/24	222 212
12	48	12	M 12X1,75	GK 12/48	222 312
14	28	14	M 14X2	GK 14/28	222 214
14	56	14	M 14X2	GK 14/56	222 314
16	32	16	M 16X2	GK 16/32	222 216
16	64	16	M 16X2	GK 16/64	222 316

Gabelgelenkbolzen mit Sicherung fork joint pins with safety device

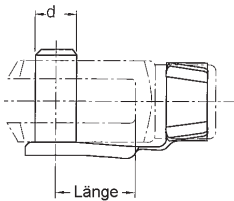

Werkstoff: Stahl, verzinkt

material: steel, galvanized

Bolzen-Ø/mm pin-Ø/mm	Länge/mm length/mm	Bezeichnung description	Art.-Nr.
5X10	10	ESB 5/10	222 505
5X20	20	ESB 5/20	222 605
6X12	12	ESB 6/12	222 506
6X24	24	ESB 6/24	222 606
8X16	16	ESB 8/16	222 508
8X32	32	ESB 8/32	222 608
10X20	20	ESB 10/20	222 510
10X40	40	ESB 10/40	222 610
12X24	24	ESB 12/24	222 512
12X48	48	ESB 12/48	222 612
14X28	28	ESB 14/28	222 514
14X56	56	ESB 14/56	222 614
16X32	32	ESB 16/32	222 516
16X64	64	ESB 16/64	222 616

Gabelgelenkbolzen fork joint pins

DIN 1434

Werkstoff: Stahl, verzinkt

material: steel, galvanized

Bolzen-Ø/mm pin-Ø/mm (d)	Gesamtlänge/mm overall length/mm (l)	Länge/mm length/mm (l1)	Splint-Ø/mm split pin-Ø/mm (d2)	Bezeichnung description	Art.-Nr.
5	12	10,0	1,6	GB0 5	222 405
6	18	14,5	1,6	GB0 6	222 406
8	23	18,7	2,0	GB0 8	222 408
10	29	23,2	3,2	GB0 10	222 410
12	35	28,2	4,0	GB0 12	222 412
14	40	31,2	4,0	GB0 14	222 414
14	45	40,0	4,0	GB0 14X45	222 434
16	45	36,2	4,0	GB0 16	222 416
20	54	47,0	4,0	GB0 20	222 420



Gabelgelenkbolzen DC fork joint pins DC

für Daimler-Chrysler Nutzfahrzeuge

Werkstoff: Stahl, verzinkt/Nylon

for Daimler-Chrysler motor vehicles

material: steel, galvanized/nylon

Bolzen-Ø/mm pin-Ø/mm (d)	Gesamtlänge/mm overall length/mm (l)	Länge/mm length/mm (l1)	Splint-Ø/mm split pin-Ø/mm (d2)	Bezeichnung description	Art.-Nr.
10	35	30,5	3,2	GB0 30 DC	222 454
10	37	32,0	3,2	GB0 39 DC	222 457
12	40	36,0	4,0	GB0 35 DC	222 456

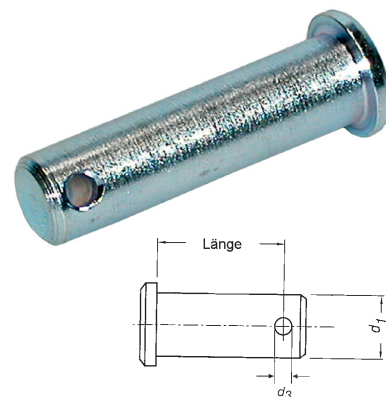

Scheiben für Gabelgelenkbolzen disks for fork joint pins

DIN 433

Werkstoff: Stahl, verzinkt

material: steel, galvanized

Gelenkbolzen-Ø/mm fork joint pins-Ø/mm	Scheibeninnen-Ø/mm disk inside-Ø/mm	Bezeichnung description	Art.-Nr.
5	5,3	US 5,3	222 805
6	6,4	US 6,4	222 806
8	8,4	US 8,4	222 808
10	10,5	US 10,5	222 810
12	13	US 13	222 812
14	15	US 15	222 814
16	17	US 17	222 816
20	21	US 21	222 820

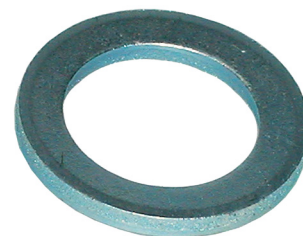

Splinte für Gabelgelenkbolzen

split pins for fork joint pins

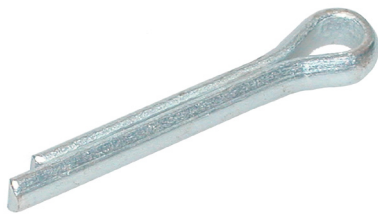

DIN 94

Werkstoff: Stahl, verzinkt

material: steel, galvanized

Gelenkbolzen-Ø/mm fork joint pins-Ø/mm	Splint-Ø/mm spli pin-Ø/mm	Länge length	Bezeichnung description	Art.-Nr.
5+6	1,6	10	Splint 1,6X10	222 701
8	2,0	16	Splint 2,0X16	222 702
10	3,2	20	Splint 3,2X20	222 703
12,14,16+20	4,0	32	Splint 4,0X32	222 704

Ölablass- und Verschluss- schrauben

Oil drain and lock plugs



Ölablassschrauben mit Ventil und Zubehör

Oil drain plugs with valve and accessories

Verschlusschrauben DIN 910

Lock plugs

DIN 7604

DIN 910

DIN 7604

DIN 908

DIN 908

DIN 906

DIN 906

Verschlusschrauben DIN 910

lock plugs DIN 910

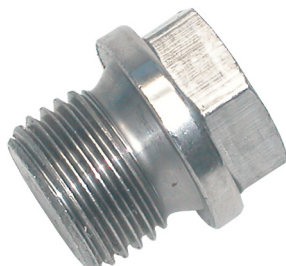

mit metrischem Gewinde

Werkstoff: Stahl, blank

Einschraubgewinde: metrisches Feingewinde, zylindrisch

Einschraubzapfen: Form A (DIN 3852)

with metric thread

material: steel, shiny

screw-in thread: metric fine thread, cylindrical

screwed plug: form A (DIN 3852)

Gewinde thread	Einschraublänge/mm screw-in length/mm	Schlüsselweite width across flats	Bezeichnung description	Art.-Nr.
M 8X1	8	12	VS 08	223 008
M 10X1,0	8	10	VS 10	223 010
M 12X1,5	12	13	VS 12	223 012
M 14X1,5	12	13	VS 14	223 014
M 16X1,5	12	17	VS 16	223 016
M 18X1,5	12	17	VS 18	223 018
M 20X1,5	14	19	VS 20	223 020
M 22X1,5	14	19	VS 22	223 022
M 24X1,5	14	22	VS 24	223 024
M 26X1,5	16	24	VS 26	223 026
M 27X2,0	16	24	VS 27X2	223 027
M 30X1,5	16	24	VS 30	223 030
M 30X2,0	16	24	VS 30X2	223 031
M 33X2,0	16	27	VS 33X2	223 033
M 36X1,5	16	27	VS 36	223 036
M 36X2,0	16	27	VS 36X2	223 037
M 38X1,5	16	27	VS 38	223 038
M 39X2,0	16	27	VS 39X2	223 039
M 42X1,5	16	30	VS 42	223 040
M 42X2,0	16	30	VS 42X2	223 041
M 45X1,5	16	30	VS 45	223 042
M 45X2,0	16	30	VS 45X2	223 043
M 48X1,5	16	30	VS 48	223 044
M 48X2,0	16	30	VS 48X2	223 045
M 52X1,5	16	30	VS 52	223 046
M 56X2,0	20	36	VS 56X2	223 047
M 60X2,0	20	36	VS 60X2	223 048
M 64X2,0	20	36	VS 64X2	223 049

mit zölligem Gewinde

Werkstoff: Stahl, blank

Einschraubgewinde: Whitworth Rohrgewinde (BSPP), zylindrisch

Einschraubzapfen: Form A (DIN 3852)

with inch thread

material: steel, shiny

screw-in thread: Whitworth pipe thread (BSPP), cylindrical

screwed plug: form A (DIN 3852)

Gewinde thread	Einschraublänge/mm screw-in length/mm	Schlüsselweite width across flats	Bezeichnung description	Art.-Nr.
G 1/8"	8	10	VS 1/8"	223 055
G 1/4"	12	13	VS 1/4"	223 050
G 3/8"	12	17	VS 3/8"	223 051
G 1/2"	14	19	VS 1/2"	223 052
G 3/4"	16	24	VS 3/4"	223 053
G 1"	16	27	VS 1"	223 054
G 1 1/8"	16	27	VS 1 1/8"	223 058
G 1 1/4"	16	30	VS 1 1/4"	223 056
G 1 1/2"	16	30	VS 1 1/2"	223 057
G 1 3/4"	20	36	VS 1 3/4"	223 059
G 2"	20	36	R 2"	223 060

Verschlusschrauben DIN 908

lock plugs DIN 908

mit metrischem Gewinde und Innensechskant

Werkstoff: Stahl, verzinkt

Einschraubgewinde: metrisches Feingewinde, zylindrisch

Einschraubzapfen: Form A (DIN 3852)

with metric thread and hexagon socket

material: steel, galvanized

screw-in thread: metric fine thread, cylindrical

screwed plug: form A (DIN 3852)



Gewinde thread	Einschraublänge/mm screw-in length/mm	Schlüsselweite width across flats	Bezeichnung description	Art.-Nr.
M 8X1	8	4	VSTI 8	223 700
M 10X1,0	8	5	VSTI 10	223 701
M 12X1,5	12	6	VSTI 12	223 702
M 14X1,5	12	6	VSTI 14	223 703
M 16X1,5	12	8	VSTI 16	223 704
M 18X1,5	12	8	VSTI 18	223 705
M 20X1,5	14	10	VSTI 20	223 706
M 22X1,5	14	10	VSTI 22	223 707
M 24X1,5	14	12	VSTI 24	223 708
M 26X1,5	16	12	VSTI 26	223 709
M 27X2,0	16	12	VSTI 27X2	223 710
M 30X1,5	16	17	VSTI 30	223 711
M 30X2,0	16	17	VSTI 30X2	223 712
M 33X2,0	16	17	VSTI 33X2	223 713
M 36X1,5	16	19	VSTI 36	223 714
M 36X2,0	16	19	VSTI 36X2	223 715
M 38X1,5	16	19	VSTI 38	223 716
M 42X2,0	16	22	VSTI 42X2	223 719
M 45X1,5	16	22	VSTI 45	223 720
M 45X2,0	16	22	VSTI 45X2	223 721
M 48X1,5	16	24	VSTI 48	223 722
M 48X2,0	16	24	VSTI 48X2	223 723
M 52X1,5	16	24	VSTI 52	223 724
M 52X2,0	16	24	VSTI 52X2	223 725
M 56X2,0	20	32	VSTI 56X2	223 726
M 60X2,0	20	32	VSTI 60X2	223 727
M 64X2,0	20	32	VSTI 64X2	223 728

mit zölligem Gewinde und Innensechskant

Werkstoff: Stahl, verzinkt

Einschraubgewinde: Whitworth Rohrgewinde (BSPP), zylindrisch

Einschraubzapfen: Form A (DIN 3852)

with inch thread and hexagon socket

material: steel, galvanized

screw-in thread: Whitworth pipe thread (BSPP), cylindrical

screwed plug: form A (DIN 3852)

Gewinde thread	Einschraublänge/mm screw-in length/mm	Schlüsselweite width across flats	Bezeichnung description	Art.-Nr.
G 1/8"	8	5	VSTI 1/8"	223 731
G 1/4"	12	6	VSTI 1/4"	223 732
G 3/8"	12	8	VSTI 3/8"	223 733
G 1/2"	14	10	VSTI 1/2"	223 734
G 3/4"	16	12	VSTI 3/4"	223 735
G 1"	16	17	VSTI 1"	223 736
G 1 1/8"	16	19	VSTI 1 1/8"	223 737
G 1 1/4"	16	22	VSTI 1 1/4"	223 738
G 1 1/2"	16	24	VSTI 1 1/2"	223 739
G 1 3/4"	20	32	VSTI 1 3/4"	223 740
G 2"	20	32	VSTI 2"	223 741

Verschlusschrauben DIN 906

lock plugs DIN 906



mit metrischem kegeligen Gewinde und Innensechskant

Werkstoff: Stahl, verzinkt

Einschraubgewinde: metrisches Feingewinde, kegelig

Einschraubzapfen: Form C (DIN 3852)

with tapered metric internal thread and hexagon socket

material: steel, galvanized

screw-in thread: metric fine thread, tapered

screwed plug: form C (DIN 3852)

Gewinde thread	Einschraublänge/mm screw-in length/mm	Schlüsselweite width across flats	Bezeichnung description	Art.-Nr.
M 8X1,0	8	4	VSTI 08 K	223 750
M 10X1,0	8	5	VSTI 10 K	223 751
M 12X1,5	10	6	VSTI 12 K	223 752
M 14X1,5	10	7	VSTI 14 K	223 753
M 16X1,5	10	8	VSTI 16 K	223 754
M 18X1,5	10	8	VSTI 18 K	223 755
M 20X1,5	10	10	VSTI 20 K	223 756
M 22X1,5	10	10	VSTI 22 K	223 757
M 24X1,5	12	12	VSTI 24 K	223 758
M 26X1,5	12	12	VSTI 26 K	223 759
M 27X2,0	12	12	VSTI 27X2 K	223 760
M 30X1,5	12	17	VSTI 30 K	223 761
M 30X2,0	12	17	VSTI 30X2 K	223 762
M 36X1,5	15	19	VSTI 36 K	223 764
M 38X1,5	15	19	VSTI 38 K	223 766
M 42X2,0	18	22	VSTI 42X2 K	223 769
M 45X1,5	18	22	VSTI 45 K	223 770
M 48X1,5	20	24	VSTI 48 K	223 772
M 48X2,0	20	24	VSTI 48X2 K	223 773
M 52X1,5	20	24	VSTI 52 K	223 774
M 60X2,0	22	32	VSTI 60X2 K	223 777

mit zölligem kegeligen Gewinde

Werkstoff: Stahl, verzinkt

Einschraubgewinde: Whitworth Rohrgewinde (BSPP), kegelig

Einschraubzapfen: Form C (DIN 3852)

with tapered inch thread

material: steel, galvanized

screw-in thread: Whitworth pipe thread (BSPP), tapered

screwed plug: form C (DIN 3852)

Gewinde thread	Einschraublänge/mm screw-in length/mm	Schlüsselweite width across flats	Bezeichnung description	Art.-Nr.
G 1/8"	8	5	VSTI 1/8" K	223 781
G 1/4"	10	7	VSTI 1/4" K	223 782
G 3/8"	10	8	VSTI 3/8" K	223 783
G 1/2"	10	10	VSTI 1/2" K	223 784
G 3/4"	12	12	VSTI 3/4" K	223 785
G 1"	12	17	VSTI 1" K	223 786
G 1 1/4"	18	22	VSTI 1 1/4" K	223 787
G 1 1/2"	20	24	VSTI 1 1/2" K	223 788

Verschlusschrauben DIN 7604

lock plugs DIN 7604

mit metrischem Gewinde

Werkstoff: Stahl, verzinkt

Einschraubgewinde: metrisches Feingewinde, zylindrisch

Einschraubzapfen: Form A (DIN 3852)

with metric thread

material: steel, galvanized

screw-in thread: metric fine thread, cylindrical

screwed plug: form A (DIN 3852)



Gewinde thread	Einschraublänge/mm screw-in length/mm	Schlüsselweite width across flats	Bezeichnung description	Art.-Nr.
M10X1,0	6	14	VS 10 kurz/short	223 081
M12X1,5	9	17	VS 12 kurz/short	223 082
M14X1,5	9	19	VS 14 kurz/short	223 083
M16X1,5	9	22	VS 16 kurz/short	223 084
M18X1,5	9	17	VS 18 kurz/short	223 085
M22X1,5	9	19	VS 22 kurz/short	223 086
M26X1,5	9	22	VS 26 kurz/short	223 087
M30X1,5	9	22	VS 30 kurz/short	223 088
M 8X1	8	12	VS 08 lang/long	223 091
M 10X1,0	8	14	VS 10 lang/long	223 092
M 22X1,5	12	19	VS 22 lang/long	223 093
M 26X1,5	12	22	VS 26 lang/long	223 094
M 30X1,5	12	22	VS 30 lang/long	223 095
M 38X1,5	12	22	VS 38 lang/long	223 096
M 45X1,5	12	24	VS 45 lang/long	223 097
M 52X1,5	12	27	VS 52 lang/long	223 098

Ölablassschrauben mit Ventil

oil drains plug with valve

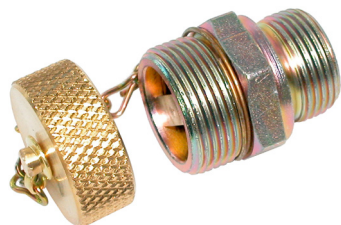

mit metrischem Gewinde

Werkstoff: Stahl verzinkt (ST) bzw. Messing (MS), siehe Tabelle

Einschraubgewinde: metrisches Feingewinde, zylindrisch

with metric thread

material: steel, galvanized (ST) or brass (MS), see table

screw-in thread: metric fine thread, cylindrical

Einschraubgewinde screw-in thread	Anschlussgewinde connection thread	Bezeichnung description	Art.-Nr.
M 12X1,5	M 22X1,5	VS 12 BST ST	223 112
M 14X1,5	M 22X1,5	VS 14 BST ST	223 114
M 16X1,5	M 22X1,5	VS 16 BST ST	223 116
M 18X1,5	M 22X1,5	VS 18 BST ST	223 118
M 18X1,5	M 26X1,5	VS 18/26 BST ST	223 168
M 20X1,5	M 26X1,5	VS 20 BST ST	223 120
M 21X1,5	M 26X1,5	VS 21 BST ST	223 121
M 22X1,5	M 26X1,5	VS 22 BST ST	223 122
M 24X1,5	M 26X1,5	VS 24 BST MS	223 124
M 24X2,0	M 26X1,5	VS 24X2,0 BST MS	223 175
M 26X1,5	M 26X1,5	VS 26 BST MS	223 126
M 28X1,5	M 26X1,5	VS 28 BST MS	223 128
M 30X1,5	M 26X1,5	VS 30X1,5 BST MS	223 130
M 32X1,5	M 26X1,5	VS 32X1,5 BST MS	223 132
M 36X1,5	M 26X1,5	VS 36X1,5 BST MS	223 136
M 38X1,5	M 26X1,5	VS 38X1,5 BST MS	223 138



mit zölligem Gewinde

Werkstoff: Stahl verzinkt (ST) bzw. Messing (MS), siehe Tabelle

Einschraubgewinde: Whitworth Rohrgewinde (BSPP), zylindrisch

with inch thread

material: steel, galvanized (ST) or brass (MS), see table

screw-in thread: Whitworth pipe thread (BSPP), cylindrical

Einschraubgewinde screw-in thread	Anschlussgewinde connection thread	Bezeichnung description	Art.-Nr.
G 1/4"	M 22X1,5	VS 1/4" BST ST	223 150
G 3/8"	M 22X1,5	VS 3/8" BST ST	223 151
G 1/2"	M 26X1,5	VS 1/2" BST ST	223 152
G 3/4"	M 26X1,5	VS 3/4" BST ST	223 153
G 1"	M 26X1,5	VS 1" BST MS	223 154



mit UNF Gewinde

Werkstoff: Stahl verzinkt (ST) bzw. Messing (MS), siehe Tabelle

Einschraubgewinde: amerikanisches Normgewinde UNF-UN, zylindrisch

with UNF thread

material: steel, zinc-plated (ST) or brass (MS), see table

screw-in thread: american standard thread UNF-UN, cylindrical

Einschraubgewinde screw-in thread	Anschlussgewinde connection thread	Bezeichnung description	Art.-Nr.
1/2"-20 UNF	M 22X1,5	VS 1/2"-20 UNF BST ST	223 161
5/8"-18 UNF	M 26X1,5	VS 5/8"-18 UNF BST ST	223 163
3/4"-16 UNF	M 26X1,5	VS 3/4"-16 UNF BST ST	223 160
7/8"-14 UNF	M 26X1,5	VS 7/8"-14 UNF BST ST	223 164
1"-12 UNF	M 26X1,5	VS 1"-12 UNF BST MS	223 162
1 1/16"-12 UN	M 26X1,5	VS 1 1/16"-12 UN BST MS	223 166
1 5/16"-12 UN	M 26X1,5	VS 1 5/16"-12 UN BST MS	223 167

Ventil-Anschlussstücke

valve connecting pieces

gerade

Werkstoff: PVC-Schlauch mit Verschlusskappe, Anschlussarmatur Messing

straight

material: PVC hose with cover cap, connection armature brass

Einschraubgewinde screw-in thread	Schlauchlänge hose length	Bezeichnung description	Art.-Nr.
M 22X1,5	250 mm	AST 22/250	223 101
M 22X1,5	500 mm	AST 22/500	223 111
M 22X1,5	1000 mm	AST 22/1000	223 103
M 26X1,5	250 mm	AST 26/250	223 100
M 26X1,5	500 mm	AST 26/500	223 110
M 26X1,5	1000 mm	AST 26/1000	223 102



Winkel 90°

Werkstoff: PVC-Schlauch mit Verschlusskappe, Anschlussarmatur Messing

angle 90°

material: PVC hose with cover cap, connection armature brass

Einschraubgewinde screw-in thread	Schlauchlänge hose length	Bezeichnung description	Art.-Nr.
M 22X1,5	250 mm	W-AST 22/250	223 105
M 26X1,5	250 mm	W-AST 26/250	223 104



Schraubkappen für Ablassventile

screw caps for drain valves

Werkstoff: Messingkappe mit Stahlkette

material: brass cap with steel chain

für Gewinde for thread	Bezeichnung description	Art.-Nr.
M 22X1,5	SCHR-KA 22	223 106
M 26X1,5	SCHR-KA 26	223 107



Dichtungen für Schraubkappen

seals for screw caps

Werkstoff: NBR

material: NBR

für Gewinde for thread	Bezeichnung description	Art.-Nr.
M 22X1,5	KAPPEN-DI 22	223 108
M 26X1,5	KAPPEN-DI 26	223 109



Notizen/notes

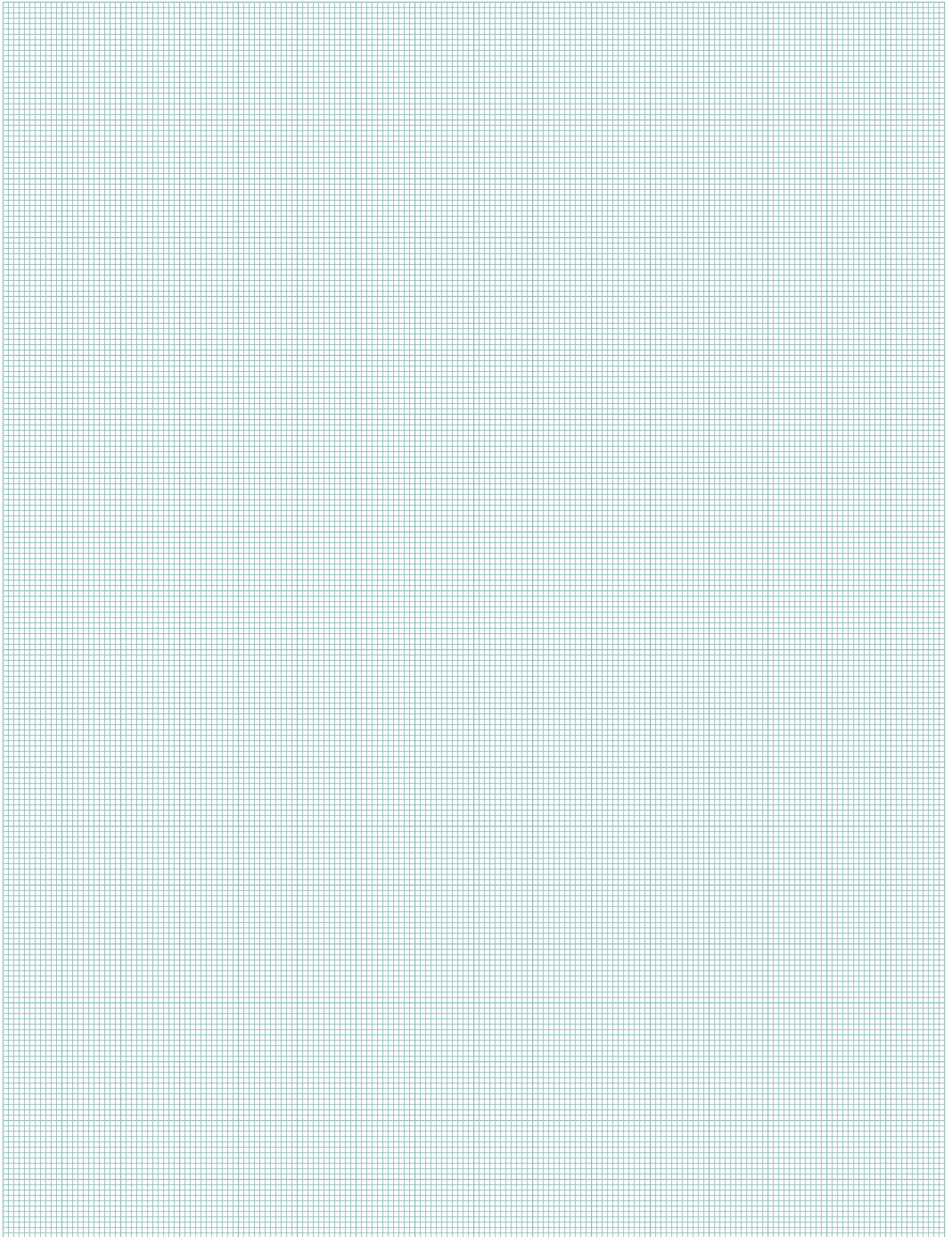

Kältemittelschlauch und Pressarmaturen

refrigerant hose and press fittings

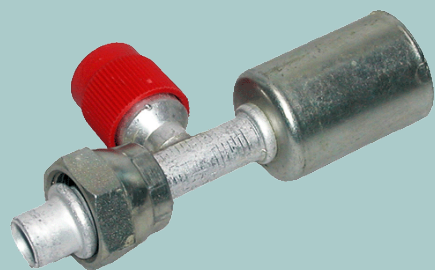
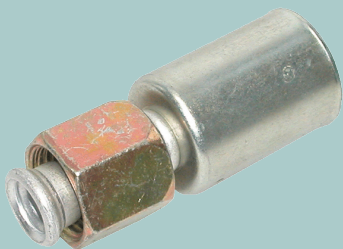
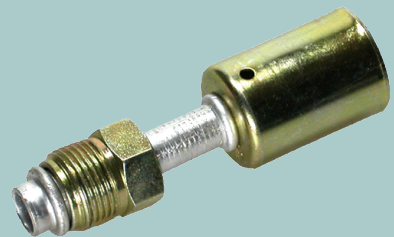
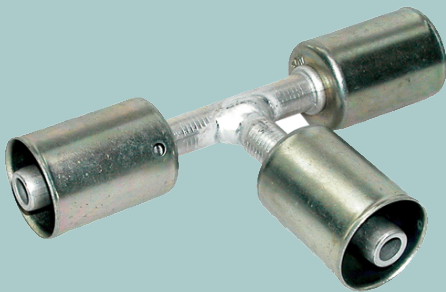

Kältemittelschlauch

Pressarmaturen

Pressverbinder

Schlauchpresse und Zubehör

refrigerant hose

press armatures

press joints

hose press and accessories

Kältemittelschlauch Typ 3055 - Barrier

refrigerant hose type 3055 - Barrier

nach SAE J 2064 Type C
für Kältemittel R12, R22, R134a und andere FKW geeignet für
mineralische Kältemaschinen- und PAG-Öle

Kennzeichnung: aufgedruckte Typennummer und Schlauchgröße
Temperaturbereich: -35°C bis +125°C

according to SAE J 2064 Type C
for refrigerants R12, R22, R134a and other FCH suitable for
mineral refrigerators and PAG oils

marking: imprinted model number and hose size
temperature range: -35°C to +125°C

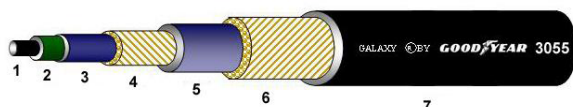

Schlauchkonstruktion/:

1. Seele aus synthetischem Kautschuk (CR) / soul of synthetic rubber (CR)
2. Polyamid-Sperrschicht / polyamide barrier layer
3. Schicht aus NBR-Kautschuk / layer of NBR rubber
4. spiralisierter Druckträger aus Polyestergera (PET) / spiraliced pressure carrier of polyester cotton (PET)
5. Schicht aus SBR-Kautschuk / layer of SBR rubber
6. spiralisierter Druckträger aus Polyestergera (PET) / spiraliced pressure carrier of polyester cotton (PET)
7. Decke aus abrieb- und wetterbeständigem synthetischem Kautschuk (EPDM), perforiert / cover of abrasion and weather-resistant synthetic rubber (EPDM), perforated

NW NS	Zoll inch	Size	Innen-Ø internal-Ø mm	Außen-Ø external-Ø mm	Betriebsdruck working press. bar	Berstdruck bursting press. bar	Biegeradius bend radius mm	Art.-Nr.
8	5/16"	6	7,9	18,3	35	120	71	651 208
10	13/32"	8	10,3	22,4	35	120	80	651 210
12	1/2"	10	12,7	24,6	35	120	88	651 212
16	5/8"	12	15,9	27,7	35	120	105	651 216

Presshülsen

press ferrules



Werkstoff: Stahl verzinkt
material: steel galvanized

für Kältemittelschlauch NW for refrigerant hose NS	Art.-Nr.
8	212 958
10	212 960
12	212 963
16	212 966

Alu-Lötnippel

aluminium soldering nipples



Werkstoff: Lötstutzen-Aluminium, Fassung-Stahl verzinkt
material: soldered bush-aluminium, ferrule-steel galvanized

für Kältemittelschlauch NW for refrigerant hose NS	für Rohr-Außen-Ø/mm for pipe outside-Ø/mm	Art.-Nr.
8	10	212 708
10	12	212 710
12	16	212 712
16	18	212 716

Alu-Rohre aluminium pipes

Werkstoff: Aluminium, zum Einlöten von Sonderfittings
material: aluminium, to solder from special fittings

Rohr-Außen-Ø/mm pipe outside-Ø/mm	Wandstärke/mm wall thickness/mm	Fixlänge fixed length	Art.-Nr.
10	1,2	2 m	212 760
12	1,2	2 m	212 762
16	1,2	2 m	212 766
18	1,2	2 m	212 768



Armaturen mit SAE-Dichtflansch 45° fittings with SAE sealing flange 45°

mit Überwurfmutter with union nut

Werkstoff: Rohr-Aluminium, Überwurfmutter und Fassung-Stahl verzinkt
material: pipe-aluminium, union nut and ferrule-steel galvanized

gerade straight

für Schlauch DN for hose NS	Gewinde thread	Art.-Nr.
8	5/8"-18 UNF	211 008
10	3/4"-16 UNF	211 010
12	7/8"-14 UNF	211 013
16	1 1/16"-14 UNS	211 016



Rohrbogen 45° tube bend 45°

für Schlauch DN for hose NS	Gewinde thread	Art.-Nr.
8	5/8"-18 UNF	211 028
10	3/4"-16 UNF	211 030
12	7/8"-14 UNF	211 033
16	1 1/16"-14 UNS	211 036

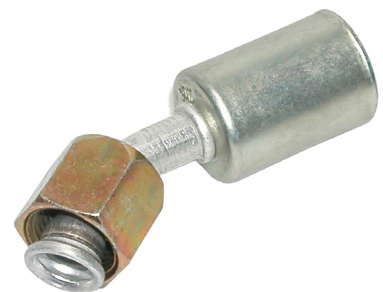

Rohrbogen 90° tube bend 90°

für Schlauch DN for hose NS	Gewinde thread	Art.-Nr.
8	5/8"-18 UNF	211 048
10	3/4"-16 UNF	211 050
12	7/8"-14 UNF	211 053
16	1 1/16"-14 UNS	211 056

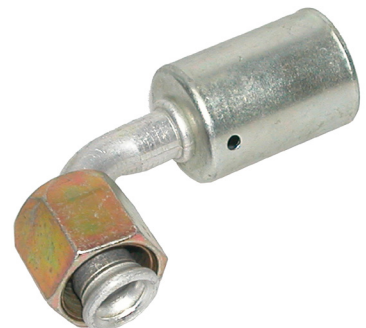

Armaturen mit SAE-Dichtkonus 45° fittings with SAE sealing flange 45°

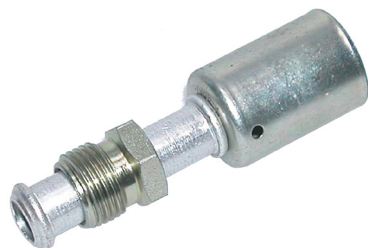

mit Überwurfschraube with union screw

Werkstoff: Rohr-Aluminium, Überwurfmutter und Fassung-Stahl verzinkt
material: pipe-aluminium, union nut and ferrule-steel galvanized

gerade straight

für Schlauch DN for hose NS	Gewinde thread	Art.-Nr.
8	5/8"-18 UNF	211 108
10	3/4"-16 UNF	211 110
12	7/8"-14 UNF	211 113
16	1 1/16"-14 UNS	211 116



Rohrbogen 45° tube bend 45°

für Schlauch DN for hose NS	Gewinde thread	Art.-Nr.
8	5/8"-18 UNF	211 128
10	3/4"-16 UNF	211 130
12	7/8"-14 UNF	211 133
16	1 1/16"-14 UNS	211 136



Rohrbogen 90° tube bend 90°

für Schlauch DN for hose NS	Gewinde thread	Art.-Nr.
8	5/8"-18 UNF	211 148
10	3/4"-16 UNF	211 150
12	7/8"-14 UNF	211 153
16	1 1/16"-14 UNS	211 156

Armaturen für O-Ring Abdichtung fittings for O-ring sealing



mit Überwurfmutter ohne O-Ring (bitte gesondert bestellen!) with union screw (please order separately!)

Werkstoff: Rohr-Aluminium, Überwurfmutter und Fassung-Stahl verzinkt
material: pipe-aluminium, union nut and ferrule-steel galvanized

gerade straight

für Schlauch DN for hose NS	Gewinde thread	Art.-Nr.
8	5/8"-18 UNF	211 208
10	3/4"-16 UNF	211 210
12	7/8"-14 UNF	211 213
16	1 1/16"-14 UNS	211 216

Armaturen für O-Ring Abdichtung

fittings for O-ring sealing

gerade reduziert

straight reduced

für Schlauch DN for hose NS	Gewinde thread	Art.-Nr.
8	3/4"-16 UNF	211 220
10	5/8"-18 UNF	211 221
12	3/4"-16 UNF	211 222
12	1 1/16"-14 UNS	211 223
16	7/8"-14 UNF	211 224



Rohrbogen 45°

tube bend 45°

für Schlauch DN for hose NS	Gewinde thread	Art.-Nr.
8	5/8"-18 UNF	211 228
10	5/8"-18 UNF	211 241
10	3/4"-16 UNF	211 230
12	3/4"-16 UNF	211 242
12	7/8"-14 UNF	211 233
16	7/8"-14 UNF	211 244
16	1 1/16"-14 UNS	211 236



Rohrbogen 90°

tube bend 90°

für Schlauch DN for hose NS	Gewinde thread	Art.-Nr.
8	3/4"-16 UNF	211 260
8	5/8"-18 UNF	211 248
10	5/8"-18 UNF	211 261
10	3/4"-16 UNF	211 250
12	3/4"-16 UNF	211 262
12	7/8"-14 UNF	211 253
12	1 1/16"-14 UNF	211 263
16	7/8"-14 UNF	211 264
16	1 1/16"-14 UNS	211 256



Armaturen für O-Ring Abdichtung

fittings for O-ring sealing

mit Überwurfmutter ohne O-Ring (bitte gesondert bestellen!)

with union screw (please order separately!)

Werkstoff: Rohr-Aluminium, Überwurfmutter und Fassung-Stahl verzinkt

material: pipe-aluminium, union nut and ferrule-steel galvanized

gerade
straight



für Schlauch DN for hose NS	Gewinde thread	Art.-Nr.
8	5/8"-18 UNF	211 308
8	3/4"-16 UNF	211 320
10	5/8"-18 UNF	211 321
10	3/4"-16 UNF	211 310
12	7/8"-18 UNF	211 313
16	7/8"-14 UNF	211 324
16	1 1/16"-14 UNS	211 316

Rohrbogen 45°

tube bend 45°



für Schlauch DN for hose NS	Gewinde thread	Art.-Nr.
8	5/8"-18 UNF	211 328
8	3/4"-16 UNF	211 340
10	5/8"-18 UNF	211 341
10	3/4"-16 UNF	211 330
12	7/8"-18 UNF	211 333
16	1 1/16"-14 UNS	211 336

Rohrbogen 90°

tube bend 90°



für Schlauch DN for hose NS	Gewinde thread	Art.-Nr.
8	5/8"-18 UNF	211 348
8	3/4"-16 UNF	211 360
10	5/8"-18 UNF	211 361
10	3/4"-16 UNF	211 350
12	7/8"-18 UNF	211 353
16	7/8"-18 UNF	211 364
16	1 1/16"-14 UNS	211 356

Armaturen mit SAE Außengewinde fittings with external thread

Werkstoff: Rohr-Aluminium, Überwurfmutter und Fassung-Stahl verzinkt
material: pipe-aluminium, union nut and ferrule-steel galvanized

gerade straight

für Schlauch DN for hose NS	Gewinde thread	Art.-Nr.
8	5/8"-18 UNF	211 408
10	3/4"-16 UNF	211 410
12	7/8"-14 UNF	211 413
16	1 1/16"-14 UNS	211 416

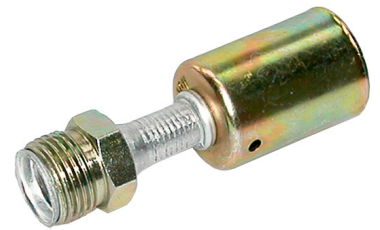

Rohrbogen 45° tube bend 45°

für Schlauch DN for hose NS	Gewinde thread	Art.-Nr.
8	5/8"-18 UNF	211 428
10	3/4"-16 UNF	211 430
12	7/8"-14 UNF	211 433



Rohrbogen 90° tube bend 90°

für Schlauch DN for hose NS	Gewinde thread	Art.-Nr.
8	5/8"-18 UNF	211 448
10	3/4"-16 UNF	211 450
12	7/8"-14 UNF	211 453

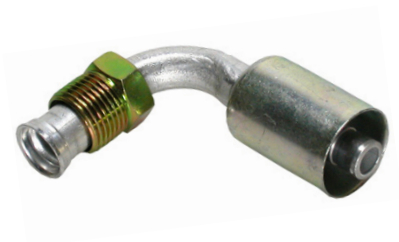

Armaturen für O-Ring Abdichtung mit Service-Ventil 134a fittings for O-ring sealing with service-valve 134a

mit Überwurfmutter ohne O-Ring (bitte gesondert bestellen!)
with union screw (please order separately!)

Werkstoff: Rohr-Aluminium, Überwurfmutter und Fassung-Stahl verzinkt
material: pipe-aluminium, union nut and ferrule-steel galvanized

gerade
straight

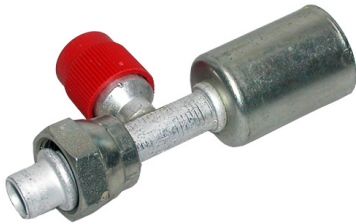

für Schlauch DN for hose NS	Gewinde thread	Ventil-Ø valve-Ø	Art.-Nr.
8	5/8"-18 UNF	16	212 208
10	3/4"-16 UNF	16	212 210
12	7/8"-14 UNF	13	212 213
16	7/8"-14 UNF	13	212 216

Rohrbogen 45°
tube bend 45°



für Schlauch DN for hose NS	Gewinde thread	Ventil-Ø valve-Ø	Art.-Nr.
8	5/8"-18 UNF	16	212 228
10	3/4"-16 UNF	16	212 230
12	7/8"-14 UNF	13	212 233

Rohrbogen 90°
tube bend 90°



für Schlauch DN for hose NS	Gewinde thread	Ventil-Ø valve-Ø	Art.-Nr.
8	5/8"-18 UNF	16	212 248
10	3/4"-16 UNF	16	212 250
12	7/8"-14 UNF	13	212 253

O-Ringe HNBR O-rings HNBR



für Fittings
geeignet für R 12, R 134a und andere Kältemittel

Werkstoff: Nitrilkautschuk

Farbe: grün

for fittings

suitable for R 12, R 134a and other refrigerants

material: Nitril rubber

colour: green

für Gewinde for thread	Abmessungen/mm dimensions/mm	Art.-Nr.
5/8"-18 UNF	7,65X1,78	212 908
3/4"-16 UNF	10,82X1,78	212 910
7/8"-14 UNF	14,00X1,78	212 913
1 1/16"-14 UNS	17,17X1,78	212 916

Ventil-Einsätze valve inserts

Bezeichnung description	Art.-Nr.
für Kältemittelfüllventil R 134a/R12 for refrigerants fill valve R 134a/R12	212 981
für Kältemittelfüllventil R 134a for refrigerants fill valve R 134a	212 982



Verschlusskappen für Serviceanschluss R 134a cover caps for service connection R 134a

Bezeichnung description	Art.-Nr.
8 mm Hochdruck/schwarz 8 mm high pressure/black	212 931
8 mm Niederdruck/schwarz 8 mm low pressure/black	212 932
10 mm Niederdruck/rot 10 mm low pressure/red	212 936
9 mm Hochdruck/blau 9 mm high pressure/blue	212 937

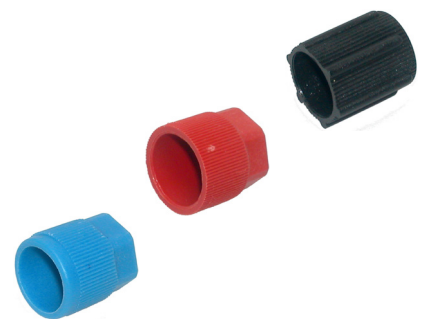

Press-Verbinder press joints

zur Verbindung von Kältemittelschlauchenden for connecting refrigerants hose ends

Werkstoff: Rohr-Aluminium, Fassung-Stahl verzinkt
material: pipe-aluminium, ferrule-steel galvanized

gerade straight

für Schlauch DN for hose NS	Art.-Nr.
8	212 608
10	212 610
12	212 613
16	212 616



Rohrbogen 90° tube bend 90°

für Schlauch DN for hose NS	Art.-Nr.
8	212 628
10	212 630
12	212 633
16	212 636



Press-Verbinder press joints



zur Verbindung von Kältemittelschlauchenden for connecting refrigerants hose ends

Werkstoff: Rohr-Aluminium, Fassung-Stahl verzinkt
material: pipe-aluminium, ferrule-steel galvanized

T-Verbinder T-connector

für Schlauch DN
for hose NS

Art.-Nr.

8	212 648
10	212 650
12	212 653
16	212 656



Rohrbogen 180° tube bend 180°

für Schlauch DN
for hose NS

Art.-Nr.

8	212 668
10	212 670
12	212 673
16	212 676

Kältemittelschlauch-Presser refrigerant hose press

im praktischen Service-Koffer

Inhalt: Werkzeug, 6 Satz Pressbackensätze, 1 Messschieber, 1 Fläschchen Öl, Gebrauchsanleitung

in the practical service suit-case

Contents: tool, 6 press cheek sets, 1 sliding calliper, 1 bottle oil, instructions



Bezeichnung
description

Art.-Nr.

Presswerkzeug Klima
crimping tool refrigerant

209 033 01

Ersatzteile für Kältemittelschlauch-Pressen

spare parts for refrigerant hose press

Pressbackensätze

Press cheek sets

Size	NW / NS	Kennzeichnung marking	Farbe colour	Art.-Nr.
6	8	6	gelb/yellow	209 221 01
8	10	8	rot/red	209 222 01
10	12	10	grün/green	209 223 01
12	16	12	blau/blue	209 220 01

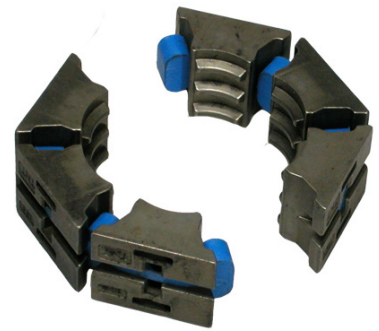

Pressbackenhalter

press cheek sockets

Size	NW / NS	für Pressbackenhalter for press cheek socket	Art.-Nr.
6	8	gelb/yellow	209 231 01
8	10	rot/red	209 232 01
10	12	grün/green	209 233 01
12	16	blau/blue	209 230 01



Pressbackensegmente

press cheek segments

Size	NW / NS	Farbe colour	Art.-Nr.
6	8	gelb/yellow	209 241 01
8	10	rot/red	209 242 01
10	12	grün/green	209 243 01
12	16	blau/blue	209 240 01



Gewindest spindle

screw pillar

Bezeichnung description	Art.-Nr.
Gewindestpindel SW 1"	209 250 01



Notizen/notes

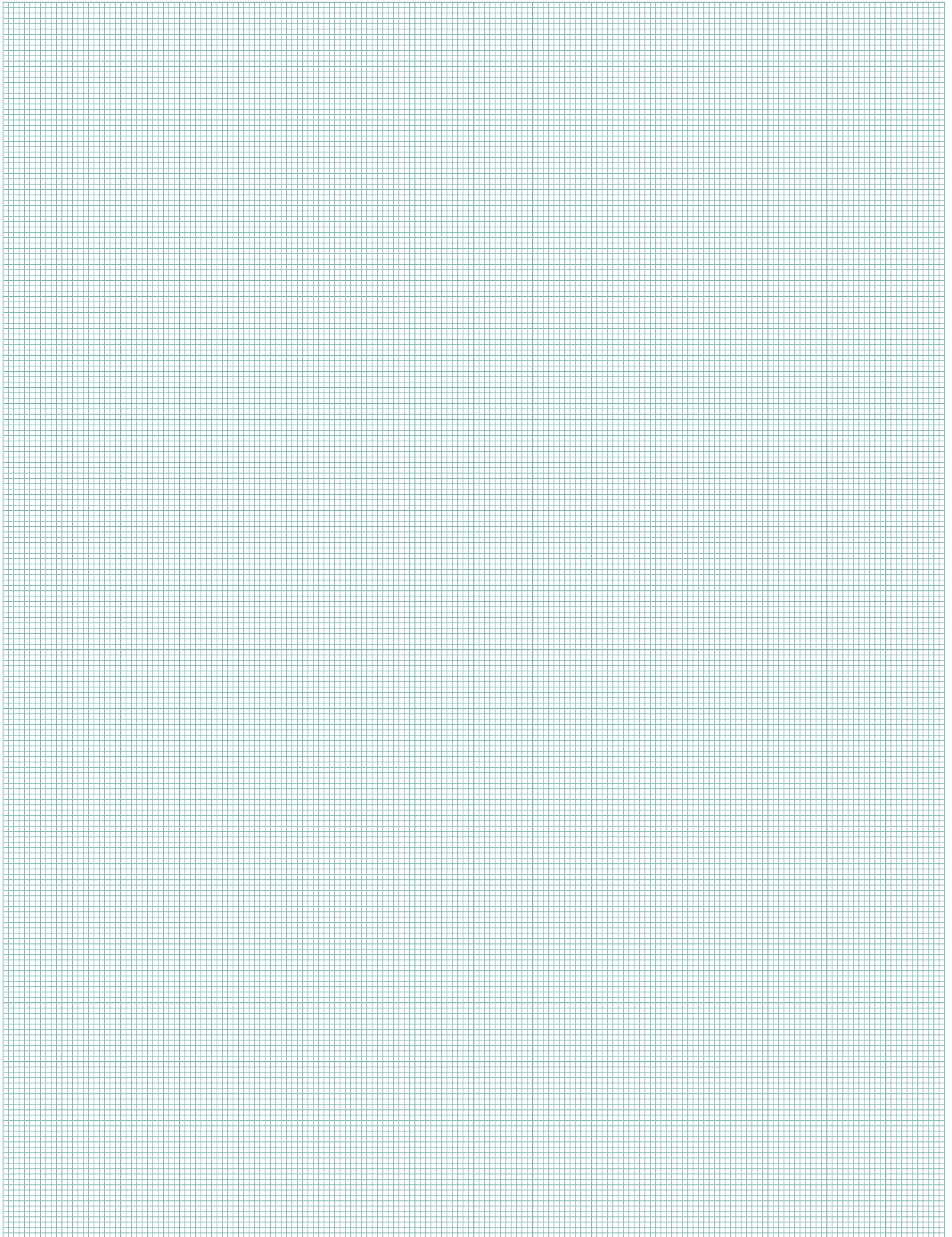

Sortimente

Assortments

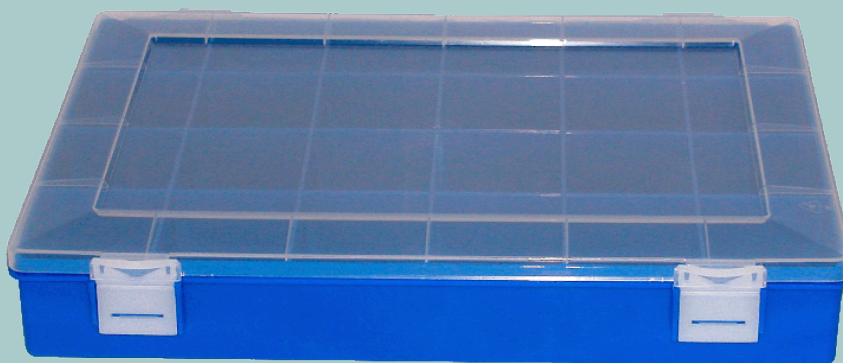

Kraftstoff- und Luftversorgung

fuel and air supply

Dichtringe

sealing rings

Zentralschmierung

central lubrication

Befestigungstechnik

fastening technology

Gelenktechnik

joint technology

Verschlusschrauben

plugs

Sortimentskästen zum selbst befüllen

assortment boxes to fill in

Stapelboxen

pile boxes

Sortiment Kraftstoff BE, CE, ÜM u. SR

assortment fuel BE, CE, UM and SR



für Niederdruckschläuche bis NW 8

for low pressure hoses up to NW 8

Das Sortiment enthält: Rohrstützen (BE), Schlauchnippel mit AG (CE), Überwurfmutter (ÜM) und Schneidringe (SR) bis NW 8

Stahlblechbox 340X240X55 mm mit Kunststoffeinsatz 18-fach

Inhalt: 180 Stück

The assortments contains: pipe nipple (BE), hose nipple with external thread (CE), union nut (ÜM) and cutting ring (SR) to NW 8

steel sheet box 340X240X55 mm with plastic insert eighteenfoldly

Contents: 180 pieces

Art.-Nr. 203 300

Stück pieces	Bezeichnung description	Art.-Nr.	Stück pieces	Bezeichnung description	Art.-Nr.
10	CE 4 Schlauchnippel	203 204	10	K 4 Doppelkegelring	230 304
10	CE 6/12X1,5 Schlauchnippel	203 207	10	M-LL 04 Überwurfmutter	432 100
10	CE 8 Schlauchnippel	203 208	10	M-L 06 Überwurfmutter	432 110
10	CE 10 Schlauchnippel	203 210	10	M-L 08 Überwurfmutter	432 111
10	BE 4 Rohrnippel	203 304	10	M-L 10 Überwurfmutter	432 112
10	BE 6 Rohrnippel	203 306	10	SR-LL 04 Schneidring	432 200
10	BE 8 Rohrnippel	203 308	10	SR-L/S 06 Schneidring	432 210
10	BE 10 Rohrnippel	203 310	10	SR-L/S 08 Schneidring	432 211
10	RV 8X1/4 Rohrverschraubung	230 202	10	SR-L/S 10 Schneidring	432 212

Sortiment Kraftstoff R, N, ÜM u. H

assortment fuel R, N, ÜM and H



für Niederdruckschläuche bis NW 8

for low pressure hoses up to NW 8

Das Sortiment enthält: Ringnippel (R), Schlauchnippel (N), Überwurfmutter (ÜM) und Presshülsen (H) bis NW 8

Stahlblechbox 340X240X55 mm mit Kunststoffeinsatz 18-fach

Inhalt: 235 Stück

The assortments contains: ring nipple (R), hose nipple (N), union nut (ÜM) and sleeve (H) to NW 8

steel sheet box 340X240X55 mm with plastic insert eighteenfoldly

Contents: 235 pieces

Art.-Nr. 203 400

Stück pieces	Bezeichnung description	Art.-Nr.	Stück pieces	Bezeichnung description	Art.-Nr.
10	R 2 Schlauchnippel	203 402	10	U 4 Überwurfmutter	203 804
10	R 4 Schlauchnippel	203 404	10	U 6 Überwurfmutter	203 806
10	R 6 Schlauchnippel	203 406	10	U 8 Überwurfmutter	203 808
10	R 8 Schlauchnippel	203 408	20	H 10 Hülse	204 010
10	N 2 Schlauchnippel	203 602	20	H 11,5 Hülse	204 011
10	N 4 Schlauchnippel	203 604	20	H 12,5 Hülse	204 012
10	N 6 Schlauchnippel	203 606	20	H 13,5 Hülse	204 013
10	N 8 Schlauchnippel	203 608	20	H 15,5 Hülse	204 015
10	U 2 Überwurfmutter	230 802	15	H 16 Hülse	204 016

Sortiment Hohlschrauben

assortment hollow screws

DIN 7643

Das Sortiment enthält: Hohlschrauben (HS)
 Stahlblechbox 340X240X55 mm mit Kunststoffeinsatz 12-fach
Inhalt: 83 Stück
The assortments contains: hollow screws (HS)
 steel sheet box 340X240X55 mm with plastic insert twelfefoldly
Contents: 83 pieces



Art.-Nr. 205 000

Stück pieces	Bezeichnung description	Art.-Nr.	Stück pieces	Bezeichnung description	Art.-Nr.
10	HS 2 Hohlschraube	205 002	5	HS 2/2 Hohlschraube	205 102
10	HS 4 Hohlschraube	205 004	5	HS 4/2 Hohlschraube	205 104
10	HS 6 Hohlschraube	205 006	5	HS 6/2 Hohlschraube	205 106
10	HS 8 Hohlschraube	205 008	5	HS 8/2 Hohlschraube	205 108
10	HS 10 Hohlschraube	205 010	5	HS 10/2 Hohlschraube	205 112
5	HS 13 Hohlschraube	205 013	3	HS 13/2 Hohlschraube	205 113

Sortiment Schlauchverbinder Kunststoff

assortment hose plastic connectors

mit Schneckengewindeschellen Typ TORRO 7,5

with worm thread clips type TORRO 7,5

Das Sortiment enthält: gerade und gerade reduzierte Verbinder, T Verbinder, Y Verbinder und TORRO-Schellen, Bandbreite 7,5 mm
 Kunststoffbox 12-fach
Inhalt: 285 St. Verbinder, 80 St. Schellen
The assortments contains: straight and straight reduced connectors, T connectors, Y connectors and TORRO clips strip width 7,5 mm
 Plastic box twelfefoldly
Contents: 285 pieces links, 80 pieces clips



Art.-Nr. 244 300

Stück pieces	Bezeichnung description	Art.-Nr.	Stück pieces	Bezeichnung description	Art.-Nr.
50	GS 4 PL Schlauchverbinder	244 301	50	TS 4 PL Schlauch T-Verbinder	244 281
25	GS 6 PL Schlauchverbinder	244 303	25	TS 6 PL Schlauch T-Verbinder	244 283
20	GS 8 PL Schlauchverbinder	244 304	10	TS 8 PL Schlauch T-Verbinder	244 284
20	GRS 8-6 PL Schlauchschelle	244 264	50	YS 4 PL Schlauchverbinder	244 251
40	SGT 8-12/7,5W2 Schlauchschelle	311 116	25	YS 6 PL Schlauchverbinder	244 253
40	SGT 10-16/7,5W2 Schlauchschelle	311 117	10	YS 8 PL Schlauchverbinder	244 254

Sortiment Steckverbinder assortment plug connector



für Polyamidrohr for polyamide pipe

Stahlblechbox 340X240X55 mm mit Kunststoffeinsatz 12-fach

Inhalt: 37 Stück

steel sheet box 340X240X55 mm with plastic insert twelvefoldly

Contents: 37 pieces

Art.-Nr. 301 299

Stück pieces	Bezeichnung description	Art.-Nr.	Stück pieces	Bezeichnung description	Art.-Nr.
3	G-LL 4 SV Verbinder	244 317	1	G-L 12 SV-T Verbinder	301 253
5	G-LL 5 SV Verbinder	244 319	1	G-L 14 SV-T Verbinder	301 256
5	G-L 6 SV-T Verbinder	301 250	2	G-L 15 SV-T Verbinder	301 254
5	G-L 8 SV-T Verbinder	301 251	2	G-L 16 SV-T Verbinder	301 255
3	G-L 9 SV-T Verbinder	301 258	2	T-L 16 SV-T Verbinder	301 270
4	G-L 10 SV-T Verbinder	301 252	2	T-L 15 SV-T Verbinder	301 271
2	G-L 11 SV-T Verbinder	301 259			

Sortiment Ringnippel assortment ring nipple



für Polyamidrohr mit Schlüsselfläche for polyamide pipe with flat

Das Sortiment enthält: Ringnippel zum Einschlagen in das Poly-Rohr und einen Polyamidrohr-Abschneider

Stahlblechbox 340X240X55 mm mit Kunststoffeinsatz 17-fach

Inhalt: 96 Stück

The assortments contains: ring nipple for hitting into the PA pipe and one PA pipe cutter

steel sheet box 340X240X55 mm with plastic insert seventeenfoldly

Contents: 96 pieces

Art.-Nr. 205 392

Stück pieces	Bezeichnung description	Art.-Nr.	Stück pieces	Bezeichnung description	Art.-Nr.
5	R 2 f. ID 4 mm PO SF	205 509	10	R 8 f. ID 6 mm PO SF	205 512
5	R 2 f. ID 5 mm PO SF	205 513	10	R 8 f. ID 8 mm PO SF	205 506
5	R 4 f. ID 4 mm PO SF	205 510	5	R 8 f. ID 9 mm PO SF	205 514
5	R 4 f. ID 6 mm PO SF	205 505	5	R 10 f. ID 4 mm PO SF	205 502
10	R 6 f. ID 4 mm PO SF	205 524	5	R 10 f. ID 6 mm PO SF	205 507
5	R 6 f. ID 5 mm PO SF	205 517	5	R 10 f. ID 8 mm PO SF	205 501
5	R 6 f. ID 6 mm PO SF	205 518	5	R 10 f. ID 9 mm PO SF	205 500
5	R 6 f. ID 8 mm PO SF	205 504	1	Polyamidrohrabschneider	209 010
5	R 8 f. ID 4 mm PO SF	205 503			

Sortiment Verstärkungshülsen assortment reinforcement sleeves

für Polyamidrohr for PA pipe

Das Sortiment enthält: Verstärkungshülsen für Poly-Rohr zum Verbinden mit Schneidringverschraubungen

Stahlblechbox 340X240X55 mm mit Kunststoffeinsatz 12-fach

Inhalt: 780 Stück

The assortments contains: reinforcement cases for PA pipe for connecting with cutting ring connectors

steel sheet box 340X240X55 mm with plastic insert twelvefoldly

Contents: 780 pieces



Art.-Nr. 244 199

Stück pieces	Bezeichnung description	Art.-Nr.	Stück pieces	Bezeichnung description	Art.-Nr.
100	VH 4X1 PO Verst. Hülse	244 127	50	VH 8X1,5 PO Verst. Hülse	244 141
100	VH 6X1 PO Verst. Hülse	244 120	50	VH 10X1,5 PO Verst. Hülse	244 142
100	VH 8X1 PO Verst. Hülse	244 121	50	VH 12X1,5 PO Verst. Hülse	244 143
100	VH 10X1 PO Verst. Hülse	244 122	100	VH 15X1,5 PO Verst. Hülse	244 144
50	VH 12X1 PO Verst. Hülse	244 123	30	VH 18X2 PO Verst. Hülse	244 166
50	VH 6X1,5 PO Verst. Hülse	244 140			

Sortiment U-Seal-Dichtringe assortment u-seal rings

mit Zentrierlippe with centering lip

Das Sortiment enthält: die gängigsten metallischen Flachdichtungen mit innen anvulkanisiertem Dichtwulst

Stahlblechbox 340X240X55 mm mit Kunststoffeinsatz 18-fach

Inhalt: 260 Stück

The assortments contains: the most usual metallic gaskets with sealing bulge vulcanized inside

steel sheet box 340X240X55 mm with plastic insert eighteenfoldly

Contents: 260 pieces



Art.-Nr. 431 399

Stück pieces	Bezeichnung description	Art.-Nr.	Stück pieces	Bezeichnung description	Art.-Nr.
20	U-Seal Ring 6,7X11,0X1,0	431 352	20	U-Seal Ring 18,7X26,0X1,5	431 372
20	U-Seal Ring 8,7X14,0X1,0	431 356	20	U-Seal Ring 21,54X28,58X2,5	431 374
20	U-Seal Ring 10,37X15,88X2,0	431 361	10	U-Seal Ring 22,7X30,0X2,5	431 376
20	U-Seal Ring 10,7X16,08X1,5	431 364	10	U-Seal Ring 24,7X32,0X2,0	431 378
20	U-Seal Ring 12,7X19,0X1,5	431 365	10	U-Seal Ring 27,05X34,93X2,5	431 379
20	U-Seal Ring 13,74X20,57X2,0	431 366	10	U-Seal Ring 33,89X42,8X3,2	431 383
20	U-Seal Ring 14,7X22,0X1,5	431 366	5	U-Seal Ring 42,93X52,38X3,2	431 387
20	U-Seal Ring 16,7X24,0X1,5	431 369	5	U-Seal Ring 48,44X58,60X3,2	431 388
20	U-Seal Ring 17,28X23,8X2,0	431 370			

Sortiment Kupfer-Dichtringe assortment copper sealing rings



DIN 7603

Das Sortiment enthält: die gängigsten Kupferdichtringe von 6 - 30 mm Innen-Ø
Stahlblechbox 340X240X55 mm mit Kunststoffeinsatz 18-fach

Inhalt: 1600 Stück

The assortments contains: the most usual copper sealing rings from 6 to 30 mm of inside-Ø
steel sheet box 340X240X55 mm with plastic insert eighteenfoldly

Contents: 1600 pieces

Art.-Nr. 100 500

Stück pieces	Bezeichnung description	Art.-Nr.	Stück pieces	Bezeichnung description	Art.-Nr.
100	L6/10 KU	100 505	100	L16/20 KU	100 585
100	L8/12 KU	100 514	100	L16/22 KU	100 588
100	L8/14 KU	100 517	100	L18/24 KU	100 601
100	L10/14 KU	100 531	100	L20/26 KU	100 610
100	L10/16 KU	100 536	100	L22/27 KU	100 627
100	L12/16 KU	100 548	50	L24/30 KU	100 643
100	L12/18 KU	100 554	50	L26/32 KU	100 651
100	L14/18 KU	100 568	50	L28/34 KU	100 658
100	L14/20 KU	100 572	50	L30/36 KU	100 662

Sortiment Kupfer-Dichtringe - zöllig assortment copper sealing rings - inch



DIN 7603 – G 1/8“ bis 1 1/2“ DIN 7603 – G 1/8“ up to 1 1/2“

Das Sortiment enthält: Kupferdichtringe für Whitworth-Rohrgewinde von IG R 1/8“
bis AG G 1 1/2“

Stahlblechbox 340X240X55 mm mit Kunststoffeinsatz 18-fach

Inhalt: 1170 Stück

The assortments contains: copper sealing rings for Whitworth pipe threads of internal thread
R 1/8“ to external thread G 1 1/2“

steel sheet box 340X240X55 mm with plastic insert eighteenfoldly

Contents: 1170 pieces

Art.-Nr. 100 798

Stück pieces	Bezeichnung description	Art.-Nr.	Stück pieces	Bezeichnung description	Art.-Nr.
100	L 4/8 KU Dichtring	100 501	100	L 21/27 KU Dichtring	100 619
100	L 5/11 KU Dichtring	100 504	50	L 24/30 KU Dichtring	100 643
100	L 8/14 KU Dichtring	100 517	100	L 27/32 KU Dichtring	100 656
100	L 10/14X1,5 KU Dichtring	100 532	60	L 33/39 KU Dichtring	100 668
100	L 10/18X1,5 KU Dichtring	100 541	25	L 36/44 KU Dichtring	100 674
100	L 13/18 KU Dichtring	100 563	25	L 42/49 KU Dichtring	100 683
100	L 16/24X1,5 KU Dichtring	100 590	10	L 48/55 KU Dichtring	100 690
100	L 17/23 KU Dichtring	100 593			

Sortiment Füll-Dichtringe CU-AFM

assortment filling sealing rings CU-AFM

DIN 7603 Form C

Das Sortiment enthält: Kupferfülldichtringe aus SF-CU und einem asbestfreien Füllstoff aus mineralischen und keramischen Fasern
Stahlblechbox 340X240X55 mm mit Kunststoffeinsatz 12-fach

Inhalt: 820 Stück

The assortments contains: copper filling sealing rings from SF-CU and a asbestos-free filler from mineral and ceramic fiber

steel sheet box 340X240X55 mm with plastic insert twelvefoldly

Contents: 820 pieces



Art.-Nr. 100 300

Stück pieces	Bezeichnung description	Art.-Nr.	Stück pieces	Bezeichnung description	Art.-Nr.
100	L 8/12 KAF-C Dichtring	100 305	50	L 18/24 KAF-C Dichtring	100 320
100	L 8/14 KAF-C Dichtring	100 306	50	L 20/26 KAF-C Dichtring	100 324
100	L 10/16 KAF-C Dichtring	100 308	50	L 22/29 KAF-C Dichtring	100 327
100	L 12/18 KAF-C Dichtring	100 310	30	L 24/32 KAF-C Dichtring	100 330
100	L 14/20 KAF-C Dichtring	100 313	30	L 26/32 KAF-C Dichtring	100 331
100	L 16/22 KAF-C Dichtring	100 317	10	L 30/36 KAF-C Dichtring	100 337

Sortiment Alu-Dichtringe

assortment aluminium sealing rings

DIN 7603

Das Sortiment enthält: die gängigsten Aludichtringe von 6 - 30 mm Innen-Ø

Stahlblechbox 340X240X55 mm mit Kunststoffeinsatz 18-fach

Inhalt: 1600 Stück

The assortments contains: the most usual aluminium sealing rings from 6 to 30 mm of inside-Ø steel sheet box 340X240X55 mm with plastic insert eighteenfoldly

Contents: 1600 pieces



Art.-Nr. 100 400

Stück pieces	Bezeichnung description	Art.-Nr.	Stück pieces	Bezeichnung description	Art.-Nr.
100	L 6/10 ALU Dichtring	100 404	100	L 16/20 ALU Dichtring	100 428
100	L 8/12 ALU Dichtring	100 407	100	L 16/22 ALU Dichtring	100 429
100	L 8/14 ALU Dichtring	100 409	100	L 18/24 ALU Dichtring	100 431
100	L 10/14 ALU Dichtring	100 413	100	L 20/26 ALU Dichtring	100 433
100	L 10/16 ALU Dichtring	100 415	100	L 22/27 ALU Dichtring	100 434
100	L 12/16 ALU Dichtring	100 418	50	L 24/30 ALU Dichtring	100 436
100	L 12/18 ALU Dichtring	100 419	50	L 26/32 ALU Dichtring	100 439
100	L 14/18 ALU Dichtring	100 422	50	L 28/34 ALU Dichtring	100 440
100	L 14/20 ALU Dichtring	100 424	50	L 30/36 ALU Dichtring	100 442

Sortiment Fiber-Dichtringe assortment fiber sealing rings



DIN 7603

Das Sortiment enthält: die gängigsten Fiberdichtringe von 4 - 30 mm Innen-Ø
Stahlblechbox 340X240X55 mm mit Kunststoffeinsatz 18-fach

Inhalt: 1600 Stück

The assortments contains: the most usual fiber sealing rings from 4 to 30 mm of inside-Ø
steel sheet box 340X240X55 mm with plastic insert eighteenfoldly

Contents: 1600 pieces

Art.-Nr. 101 000

Stück pieces	Bezeichnung description	Art.-Nr.	Stück pieces	Bezeichnung description	Art.-Nr.
100	F 4/8 Fiberdichtring	101 001	100	F 14/18 Fiberdichtring	101 025
100	F 5/9 Fiberdichtring	101 002	100	F 15/24 Fiberdichtring	101 032
100	F 6/10 Fiberdichtring	101 003	100	F 16/20 Fiberdichtring	101 034
100	F 8/12 Fiberdichtring	101 007	100	F 16/22 Fiberdichtring	101 035
100	F 8/14 Fiberdichtring	101 008	100	F 18/24 Fiberdichtring	101 038
100	F 10/14X1,5 Fiberdichtring	101 011	50	F 22/27 Fiberdichtring	101 044
100	F 10/16 Fiberdichtring	101 012	50	F 22/29 Fiberdichtring	101 045
100	F 12/16 Fiberdichtring	101 017	50	F 26/32 Fiberdichtring	101 048
100	F 12/19 Fiberdichtring	101 019	50	F 30/36 Fiberdichtring	101 052

Sortiment Dichtungen assortment seals



für Ölablassschrauben for oil drains plug

Das Sortiment enthält: die gängigsten Dichtungen für Ölablassschrauben
Kunststoffbox 250X170X45 mm 18-fach

Inhalt: 285 Stück

The assortments contains: the most usual seals for oil drains plug
steel sheet box 250X170X45 mm with plastic insert eighteenfoldly

Contents: 285 pieces

Art.-Nr. 100 990

Stück pieces	Bezeichnung description	Art.-Nr.	Stück pieces	Bezeichnung description	Art.-Nr.
15	L 14/20 KAF-C Dichtring	100 313	25	L 12/17X1,5 KU Dichtring	100 551
20	L 16/22 KAF-C Dichtring	100 317	30	L 14/18X1,5 KU Dichtring	100 567
15	L 18/24 KAF-C Dichtring	100 320	40	L 14/20 KU Dichtring	100 572
10	L 24/32 KAF-C Dichtring	100 330	10	L 18/24 KU Dichtring	100 601
20	L 26/32 KAF-C Dichtring	100 331	10	L 22/27 KU Dichtring	100 627
30	L 14/20 ALU Dichtring	100 424	20	L 14,5/22X2 NYLON Dichtring	100 900
30	L 22/27 ALU Dichtring	100 434	10	F 20/27X3 Fiberring	101 070

Sortiment O-Ringe DKO

assortment o-rings DKO

NBR 70 Shore

Das Sortiment enthält: O-Ringe für DKOL 6 bis DKOL42 und DKOS 6 bis DKOS 38
Kunststoffbox 250X170X45 mm 18-fach

Inhalt: 290 Stück

The assortment contains: O-rings for DKOL 6 to DKOL42 and DKOS 6 to DKOS 38
plastic box 250X170X45 mm eighteenfoldly

Contents: 290 pieces

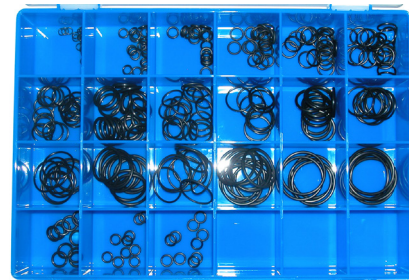

Art.-Nr. 415 397

Stck. pcs.	für for	Bezeichnung description	Art.-Nr.	Stck. pcs.	für for	Bezeichnung description	Art.-Nr.
20	DKOL/DKOS 06	O-Ring 5X1	416 110 005	10	DKOS 25/NW 25	O-Ring 23,52X1,78	416 191 021
20	DKOL/DKOS 08	O-Ring 6,07X1,78	416 191 010	10	DKOL 28	O-Ring 25,12X1,78	416 191 022
20	DKOL/DKOS 10	O-Ring 7,66X1,78	416 191 011	10	DKOS 30/NW 25	O-Ring 26,64X2,62	416 193 121
20	DKOL/DKOS 12	O-Ring 9,25X1,78	416 191 012	10	DKOS 30/NW 32	O-Ring 28,30X1,78	416 191 024
20	DKOS14/DKOL15	O-Ring 12,42X1,78	416 191 014	10	DKOL 35	O-Ring 31,42X2,62	416 193 124
20	DKOS 16	O-Ring 14,00X1,78	416 191 015	5	DKOS 38	O-Ring 34,59X2,62	416 193 126
20	DKOL 18	O-Ring 15,60X1,78	416 191 016	5	DKOL 42	O-Ring 37,77X2,62	416 193 128
20	DKOS 20/NW 16	O-Ring 17,13X2,62	416 193 115	10	KAE DKO/STNI 10mm	O-Ring 10X2,2	415 296
20	DKOS 20/NW 20	O-Ring 17,17X1,78	416 191 017	10	ST/DRSTNI 10 mm	O-Ring 6,75X1,78	415 480
10	DKOL 22	O-Ring 20,35X1,78	416 191 019	10	DRST-NI 11 mm	O-Ring 7,66X1,78	416 191 011
10	DKOS 25/NW 20	O-Ring 21,89X2,62	416 193 118				

Sortiment O-Ringe - metrisch

assortment o-rings - metric

NBR 90 Shore

Das Sortiment enthält: O-Ringe aus NBR- Kautschuk (Perbunan ®) von 10 bis 40 mm Innen-Ø

Farbe: schwarz

Kunststoffbox 330X220X50 mm 24-fach

Inhalt: 360 Stück

The assortment contains: O-rings from NBR-rubber (Perbunan ®) from 10 to 40 mm inside-Ø
colour: black

plastic box 330X220X50 mm twentyfourfoldly

Contents: 360 pieces



Art.-Nr. 415 050

Stück pieces	Bezeichnung description	Art.-Nr.	Stück pieces	Bezeichnung description	Art.-Nr.
20	O-Ring 10X2	416 220 010	10	O-Ring 24X3	416 230 024
20	O-Ring 12X2	416 220 012	10	O-Ring 25X2	416 220 025
20	O-Ring 14X2	416 220 014	10	O-Ring 25X3	416 230 025
20	O-Ring 15X2	416 220 015	10	O-Ring 28X2	416 220 028
20	O-Ring 16X2	416 220 016	10	O-Ring 28X3	416 230 028
20	O-Ring 17X2	416 220 017	10	O-Ring 30X3	416 230 030
20	O-Ring 18X2	416 220 018	10	O-Ring 32X3	416 230 032
20	O-Ring 18X3	416 230 018	10	O-Ring 34X3	416 230 034
20	O-Ring 20X2	416 220 020	10	O-Ring 36X3	416 230 036
20	O-Ring 20X3	416 230 020	10	O-Ring 38X3	416 230 038
20	O-Ring 22X2	416 220 022	10	O-Ring 40X2	416 220 040
20	O-Ring 24X2	416 220 024	10	O-Ring 40X3	416 230 040

Sortiment O-Ringe - metrisch

assortment o-rings - metric



NBR 70 Shore

Das Sortiment enthält: O-Ringe aus NBR- Kautschuk (Perbunan ®) von 3 bis 44 mm Innen-Ø

Farbe: schwarz

Kunststoffbox doppelt, 30 Abmessungen

Inhalt: 386 Stück

The assortments contains: O-rings from NBR-rubber (Perbunan ®) from 3 to 44 mm of inside-Ø

colour: black

plastic box twice, 30 dimensions

Contents: 386 pieces

Art.-Nr. 415 098

Stück pieces	Abmessungen dimensions	Art.-Nr.	Stück pieces	Abmessungen dimensions	Art.-Nr.	Stück pieces	Abmessungen dimensions	Art.-Nr.
16	3X2	416 120 003	13	14X2,5	416 125 014	12	28X3	416 130 028
16	4X2	416 120 004	13	16X2,5	416 125 016	12	30X3	416 130 030
16	5X2	416 120 005	13	17X2,5	416 125 017	12	32X3	416 130 032
16	6X2	416 120 006	13	19X2,5	416 125 019	12	33X3	416 130 033
16	7X2	416 120 007	12	19X3	416 130 019	12	35X3	416 130 033
16	8X2	416 120 008	12	20X3	416 130 020	12	36X3	416 130 035
16	10X2	416 120 010	12	22X3	416 130 022	12	38X3	416 130 036
13	10X2,5	416 125 010	12	24X3	416 130 024	9	38X4	416 130 038
13	11X2,5	416 125 011	12	25X3	416 130 025	9	41X4	416 140 041
13	12X2,5	416 125 012	12	27X3	416 130 027	9	44X4	416 140 044

Sortiment O-Ringe - zöllig

assortment o-rings - inch



NBR 70 Shore

Das Sortiment enthält: O-Ringe aus NBR- Kautschuk (Perbunan ®) von 2,90 bis 43,82 mm Innen-Ø

Farbe: schwarz

Kunststoffbox doppelt, 30 Abmessungen

Inhalt: 382 Stück

The assortments contains: O-rings from NBR-rubber (Perbunan ®) from 2,90 to 43,82 mm of inside-Ø

colour: black

plastic box twice, 30 dimensions

Contents: 382 pieces

Art.-Nr. 415 099

Stück pieces	Abmessungen dimensions	Art.-Nr.	Stück pieces	Abmessungen dimensions	Art.-Nr.	Stück pieces	Abmessungen dimensions	Art.-Nr.
20	2,90X1,78	416 191 006	13	13,95X2,62	416 193 113	10	28,17X3,53	416 195 216
20	3,68X1,78	416 191 007	13	15,54X2,62	416 193 114	10	29,75X3,53	416 195 217
20	4,48X1,78	416 191 008	13	17,13X2,62	416 193 115	10	31,34X3,53	416 195 218
20	5,28X1,78	416 191 009	13	18,72X2,62	416 193 116	10	32,92X3,53	416 195 219
20	6,07X1,78	416 191 010	10	18,64X3,53	416 195 210	10	34,52X3,53	416 195 220
20	7,66X1,78	416 191 011	10	20,22X3,53	416 195 211	10	36,10X3,53	416 195 221
20	9,25X1,78	416 191 012	10	21,82X3,53	416 195 212	10	37,69X3,53	416 195 222
13	9,19X2,62	416 193 110	10	23,40X3,53	416 195 213	7	37,47X5,33	416 197 325
13	10,78X2,62	416 193 111	10	24,99X3,53	416 195 214	7	40,65X5,33	416 197 326
13	12,37X2,62	416 193 112	10	26,58X3,53	416 195 215	7	43,82X5,33	416 197 327

Sortiment Schmiernippel assortment lubrication nipples

DIN 71 412

Das Sortiment enthält: Schmiernippel SN 6 –12, 1/8" u. 1/4" in gerader, 45° und 90° Ausführung
Stahlblechbox 340X240X55 mm
mit Kunststoffeinsatz 18-fach

Inhalt: 585 Stück

The assortment contains: Lubrication fitting SN 6 –12, 1/8" and 1/4" in straight, 45° and 90°
construction

steel sheet box 340X240X55 mm with plastic insert eighteenfoldly

Contents: 585 pieces



Art.-Nr. 221 001

Stück pieces	Bezeichnung description	Art.-Nr.	Stück pieces	Bezeichnung description	Art.-Nr.
50	SN 6 Schmiernippel	221 00 00 01	20	SN 12/45 Schmiernippel	221 02 12 10
50	SN 8 Schmiernippel	221 01 08 10	15	SN 1/8"/45 Schmiernippel	221 05 31 00
50	SN 10 Schmiernippel	221 01 10 10	15	SN 1/4"/45 Schmiernippel	221 05 32 00
25	SN 12 Schmiernippel	221 01 12 10	50	SN 6/90 Schmiernippel	221 03 06 10
25	SN 1/8" Schmiernippel	221 04 31 00	50	SN 8/90 Schmiernippel	221 03 08 10
25	SN 1/4" Schmiernippel	221 04 32 00	30	SN 10/90 Schmiernippel	221 03 10 10
50	SN 6/45 Schmiernippel	221 02 06 10	20	SN 12/90 Schmiernippel	221 03 12 10
50	SN 8/45 Schmiernippel	221 02 08 10	15	SN 1/8"/90 Schmiernippel	221 06 31 00
30	SN 10/45 Schmiernippel	221 02 10 10	15	SN 1/4"/90 Schmiernippel	221 06 32 00

Sortiment Zentralschmierung assortment central lubrication

Das Sortiment enthält: gerade und Winkel-Einschraubverschraubungen, gerade Verbinder,
Rohrverschraubungen, Verstärkungshülsen, Kegelringe, Schneidringe und Schraubarmaturen
Stahlblechbox 340X240X55 mm mit Kunststoffeinsatz 18-fach

Inhalt: 275 Stück

The assortments contains: straight and angle male unions, straight connectors, pipe unions,
reinforcement sleeves, conical rings, cutting rings and screwing armatures

steel sheet box 340X240X55 mm with plastic insert eighteenfoldly

Contents: 275 pieces



Art.-Nr. 230 200

Stück pieces	Bezeichnung description	Art.-Nr.	Stück pieces	Bezeichnung description	Art.-Nr.
10	RV 8X1/4 Rohrverschraubung	221 61 08 10	10	GE-LLM 06 M 8X1 gerade	430 002 20
10	RV 10X1/6	221 61 10 10	10	GE-LLM 06 M 6X1 gerade	430 002 19
5	AS-AG M 8X1/IG M 10X1 Anschl.	221 53 08 10	10	GE-LLM 04 M 6X1 gerade	430 000 19
25	K 4 Doppelkegelring	221 62 04 00	10	G-LL 04 gerade	430 100
25	K 6 Doppelkegelring	221 62 06 00	10	G-LL 06 gerade	430 102
25	VH 6X1 PO Vertst. Hülse	244 120	5	WE-LLM 04 M 8X1 W-Einschr. K	430 200 20
25	VH 4X1 PO Vertst. Hülse	244 127	5	WE-LLM 06 M 10X1 W-Einschr. K	430 202 21
25	VH 6X1,5 PO Vertst. Hülse	244 140	5	WE-LLM 06 M 8X1 W-Einschr. K	430 202 20
4	HAF 4 Schraubfassung	420 910	5	WE-LLM 06 M 6X1 W-Einschr. K	430 202 19
4	BE 6-L DN 04 Schraubnippel	421 910	5	WE-LLM 04 M 6X1 W-Einschr. K	430 200 19
10	GE-LLM 04 M 8X1 gerade	430 000 20	25	SR-LL 04 Schneidring	432 200
5	GE-LLM 06 M 10X1 gerade	430 002 21	25	SR-LL 06 Schneidring	432 202

Sortiment Zentralschmierung V

assortment central lubrication V



Das Sortiment enthält: gerade und Winkel-Einschraub-Steckverbinder, gerade Verbinder, Kniestücke, Verstärkungshülsen, Kegelringe, Überwurfschrauben und Dichtringe
Stahlblechbox 340X240X55 mm mit Kunststoffeinsatz 18-fach

Inhalt: 265 Stück

The assortments contains: straight and angle male unions, straight and elbow connectos, reinforcement sleeves, conical rings, male fittings and sealing rings
steel sheet box 340X240X55 mm with plastic insert eighteenfoldly

Contents: 265 pieces

Art.-Nr. 230 299

Stück pieces	Bezeichnung description	Art.-Nr.
50	L8/11,5X1 KU Dichtring	190 506
5	Verschlusssschraube M 8X1 MS	223 361
10	Überwurfschraube M 8X1/4mm PO	221 64 08 10
10	Überwurfschraube M 16X1,5/10mm	221 64 16 15
10	AS-AG M 8X1K/IG M 8X1	221 53 08 07
10	AS-AG M 10X1K/IG M 8X1	221 53 10 08
5	Knie-AG M 8X1K/IG M 8X1 MS	221 70 08 08
5	Knie-AG M 10X1K/IG M 8X1 MS	221 70 10 08
10	Kegelringe für PO 4 mm	221 57 04 00

Stück pieces	Bezeichnung description	Art.-Nr.
10	Kegelringe für PO 10 mm	221 57 10 00
50	VH 4X1 PO Verst. Hülse	244 127
50	VH 10X1,5 PO Verst. Hülse	244 142
10	GE-M 8X1/4 mm PO MS	244 381
10	GE-M 10X1/4 mm PO MS Steckverb.	244 382
5	WE-M 8X1-4 mm PO MS	244 391
5	WE-M 10X1-4 mm PO MS	244 392
5	G-LL 04 gerade Verschraubung	430 100
5	G-LL 10 gerade Verschraubung	430 104

Sortiment Schlauchschellen Typ S

assortment hose clamps type S



DIN 3017

Das Sortiment enthält: Schlauchschellen von Ø 6 – 22 mm in verschiedenen Bandbreiten (7, 9 und 12 mm)

Stahlblechbox 340X240X55 mm mit Kunststoffeinsatz 18-fach

Inhalt: 250 Stück

The assortments contains: hose clamps of diameter 6 to 22 mm in different bandwidths (7, 9 and 12 mm)

steel sheet box 340X240X55 mm with plastic insert eighteenfoldly

Contents: 250 pieces

Art.-Nr. 310 999

Stück pieces	Bezeichnung description	Art.-Nr.	Stück pieces	Bezeichnung description	Art.-Nr.
10	S 6/7 Schlauchschelle	310 597	15	S 15/9 Schlauchschelle	310 606
10	S 7/7 Schlauchschelle	310 598	15	S 16/9 Schlauchschelle	310 608
10	S 8/7 Schlauchschelle	310 599	15	S 17/9 Schlauchschelle	310 612
20	S 9/9 Schlauchschelle	310 600	15	S 18/9 Schlauchschelle	310 612
20	S 10/9 Schlauchschelle	310 601	10	S 18/12 Schlauchschelle	310 613
20	S 11/9 Schlauchschelle	310 602	10	S 19/9 Schlauchschelle	310 614
20	S 12/9 Schlauchschelle	310 603	10	S 20/9 Schlauchschelle	310 616
20	S 13/9 Schlauchschelle	310 604	10	S 21/12 Schlauchschelle	310 620
15	S 14/9 Schlauchschelle	310 605	5	S 22/9 Schlauchschelle	310 622

Werkstatt-Sortiment Typ 450 TORRO

workshop assortment type 450 TORRO

DIN 3017

Das Sortiment enthält: Schneckengewindeschellen im Spannbereich von 8 – 70 mm, Bandbreite 9 mm)

Kunststoffbox 340X230X50 mm mit Kunststoffeinsatz 12-fach

Inhalt: 500 Stück

The assortments contains: worm thread clips in the clamping range of 8 - 70 mm, bandwidth 9 mm)

plastic sheet box 340X230X50 mm with plastic insert twelfefoldly

Contents: 500 pieces

Art.-Nr. 311 120



Stück pieces	Bezeichnung description	Art.-Nr.
155	SGT 8-16/9 W2 Schlauchschelle	311 100
60	SGT 12-22/9 W2 Schlauchschelle	311 101
100	SGT 16-27/9 W2 Schlauchschelle	311 102
50	SGT 20-32/9 W2 Schlauchschelle	311 103
50	SGT 25-40/9 W2 Schlauchschelle	311 105
15	SGT 32-50/9 W2 Schlauchschelle	311 106
20	SGT 50-70/9 W2 Schlauchschelle	311 108

Werkstatt-Sortiment Typ 500 Cobra

workshop assortment type 500 Cobra

schraublos screwless

Das Sortiment enthält: schraublose Schlauchschellen im Spannbereich von 8 – 21 mm, Bandbreite 7 bzw. 8 mm

Kunststoffbox 340X240X55 mm mit Kunststoffeinsatz 12-fach

Inhalt: 500 Stück

The assortments contains: screwless hose clamps in the clamping range of 8 to 21 mm, bandwidth 7 and/or 8 mm

plastic box 340X240X55 mm with plastic insert twelfefoldly

Contents: 500 pieces

Art.-Nr. 311 650



Stück pieces	Bezeichnung description	Art.-Nr.	Stück pieces	Bezeichnung description	Art.-Nr.
30	Cobra 7,5/7 Schlauchschelle weiß	311 651	30	Cobra 12/8 Schlauchschelle schw.	311 661
25	Cobra 8,0/7 Schlauchschelle gelb	311 352	30	Cobra 13/8 Schlauchschelle gelb	311 662
25	Cobra 8,5/7 Schlauchschelle grün	311 653	30	Cobra 14/8 Schlauchschelle violett	311 663
25	Cobra 9,0/7 Schlauchschelle violett	311 654	30	Cobra 15/8 Schlauchschelle weiß	311 664
25	Cobra 9,5/7 Schlauchschelle schw.	311 655	30	Cobra 16/8 Schlauchschelle grün	311 665
25	Cobra 10,0/7 Schlauchschelle weiß	311 656	30	Cobra 17/8 Schlauchschelle schw.	311 666
25	Cobra 10,5/7 Schlauchschelle gelb	311 657	30	Cobra 18/8 Schlauchschelle gelb	311 667
25	Cobra 11,0/7 Schlauchschelle grün	311 658	30	Cobra 19/8 Schlauchschelle violett	311 668
25	Cobra 11,5/7 Schlauchschelle violett	311 659	30	Cobra 21/8 Schlauchschelle grün	311 670

Sortiment Rohrschellen Typ RSGU 1. assortment pipe clamps type RSGU 1.



DIN 3016

Das Sortiment enthält: Rohrhalterungsschellen für Rohre von Ø 6 – 20 mm in verschiedenen Bandbreiten (12, 15 und 20 mm)
Stahlblechbox 340X240X55 mm mit Kunststoffeinsatz 12-fach

Inhalt: 151 Stück

The assortments contains: pipe bracket clips for pipes of Ø 6 – 20 mm in diameter in different bandwidths (12, 15 and 20 mm)

steel sheet box 340X240X55 mm with plastic insert twelfefoldly

Contents: 151 pieces

Art.-Nr. 310 009

Stück pieces	Bezeichnung description	Art.-Nr.	Stück pieces	Bezeichnung description	Art.-Nr.
20	RSGU 1. 6/12 Rohrschelle	310 031	10	RSGU 1. 15/15 Rohrschelle	310 092
20	RSGU 1. 8/12 Rohrschelle	310 041	6	RSGU 1. 15/20 Rohrschelle	310 093
20	RSGU 1. 10/12 Rohrschelle	310 061	10	RSGU 1. 16/15 Rohrschelle	310 102
20	RSGU 1. 12/12 Rohrschelle	310 071	10	RSGU 1. 18/15 Rohrschelle	310 112
15	RSGU 1. 12/15 Rohrschelle	310 072	5	RSGU 1. 18/20 Rohrschelle	310 113
10	RSGU 1. 14/15 Rohrschelle	310 082	5	RSGU 1. 20/20 Rohrschelle	310 123

Sortiment Winkelgelenke assortment angle joints



DIN 71802

Das Sortiment enthält: Winkelgelenke in verschiedenen Ausführungen
Stahlblechbox 340X240X55 mm mit Kunststoffeinsatz 12-fach

Inhalt: 57 Stück

The assortments contains: angle joints in different executions
steel sheet box 340X240X55 mm with plastic insert twelfefoldly

Contents: 57 pieces

Art.-Nr. 220 100

Stück pieces	Bezeichnung description	Art.-Nr.	Stück pieces	Bezeichnung description	Art.-Nr.
10	WG 5 S Winkelgelenk verz.	220 125	2	WG 14 S Winkelgelenk verz.	220 134
10	WG 6 S Winkelgelenk verz.	220 126	3	WG 6 S MAN Winkelgelenk	220 152
10	WG 8 S Winkelgelenk verz.	220 128	3	WG 8 S MAN Winkelgelenk	220 153
5	WG 10 S Winkelgelenk verz.	220 130	3	WG 10 S LANG Winkelgelenk	220 156
3	WG 12 S Winkelgelenk verz.	220 132	3	WG 8 DB NYL.N Winkelgelenk	220 157

Sortiment Verschlusschrauben assortment plugs

DIN 910

Das Sortiment enthält: Verschlusschrauben mit metrischem und zölligem Einschraubgewinde, zylindrisch

Einschraubzapfen: Form A (DIN 3852)

Stahlblechbox 340X240X55 mm mit Kunststoffeinsatz 18-fach

Inhalt: 120 Stück

The assortments contains: plugs with metric an inch thread, cylindrically screwing in nipple: form A (DIN 3852)

steel sheet box 340X240X55 mm with plastic insert eightteentfoldly

Contents: 120 pieces



Art.-Nr. 223 001

Stück pieces	Bezeichnung description	Art.-Nr.	Stück pieces	Bezeichnung description	Art.-Nr.
10	VS 8 Verschlusschraube	223 008	3	VS 26 Verschlusschraube	223 026
10	VS 10 Verschlusschraube	223 010	2	VS 30 Verschlusschraube	223 030
10	VS 12 Verschlusschraube	223 012	1	VS 33 Verschlusschraube	223 033
10	VS 14 Verschlusschraube	223 014	10	VS 1/8" Verschlusschraube	223 055
10	VS 16 Verschlusschraube	223 016	10	VS 1/4" Verschlusschraube	223 050
10	VS 18 Verschlusschraube	223 018	10	VS 3/8" Verschlusschraube	223 051
5	VS 20 Verschlusschraube	223 020	5	VS 1/2" Verschlusschraube	223 052
6	VS 22 Verschlusschraube	223 022	2	VS 3/4" Verschlusschraube	223 053
4	VS 24 Verschlusschraube	223 024	1	VS 1" Verschlusschraube	223 054

Sortimentskästen leer assortment boxes empty

Werkstoff: Stahlblech lackiert mit Kunststoffeinsatz
material: steel sheet, coated with plastic employment

Abmessungen/mm dimensions/mm	Bezeichnung description	Art.-Nr.
340X240X50	12 Fach Stahlblech	194 043
340X240X50	18 Fach Stahlblech	194 044
340X240X50	17 Fach Stahlblech	194 045



Werkstoff: Kunststoff transparent
material: plastic transparent

Abmessungen/mm dimensions/mm	Bezeichnung description	Art.-Nr.
210X120X35	12 Fach Kunststoff	194 000
210X120X35	18 Fach Kunststoff	194 001
330X220X50	12 Fach Kunststoff	194 010
250X170X45	18 Fach Kunststoff	194 011



Werkstoff: Kunststoff blau, Deckel transparent
material: plastic blue, cover transparent

Abmessungen/mm dimensions/mm	Bezeichnung description	Art.-Nr.
330X220X50	24 Fach Kunststoff	194 013

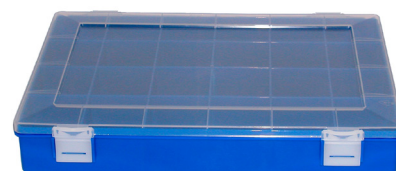

Stapelbox 3-fach

triple pile box



passend für 3 Sortimentskästen aus Stahlblech
suitable for 3 assortment boxes from steel sheet

Werkstoff: Stahlblech
material: steel sheet

Umweltfreundlich pulverbeschichtet mit Schmitter-Aufdruck
eco-friendly powder-coats with Schmitter print

Abmessungen/mm dimensions/mm	Bezeichnung description	Art.-Nr.
380X255X200	Stapel-Box 3-fach	194 101

Stapelbox 5-fach

pile box 5-fold



passend für 5 Sortimentskästen aus Stahlblech
suitable for 5 assortment boxes from steel sheet

Werkstoff: Stahlblech
material: steel sheet

Umweltfreundliche, kadmiumfreie Pulverbeschichtung, Schubladen einzeln verriegelbar,
zentral abschließbar mit leicht gängigen Teleskop-Vollauszügen
Kastendeckel im herausgezogenen Schub voll zu öffnen
eco-friendly, cadmium-free powder coating, drawers individually lockable, central lockable
easily usual telescope full excerpts to open box cover in the pulled out thrust fully

Abmessungen/mm dimensions/mm	Bezeichnung description	Art.-Nr.
415X255X435	Stapel-Box 5-fach	194 100

Klauenkupplungen und Zubehör für Druckluft

Claw couplings and accessories for compressed air

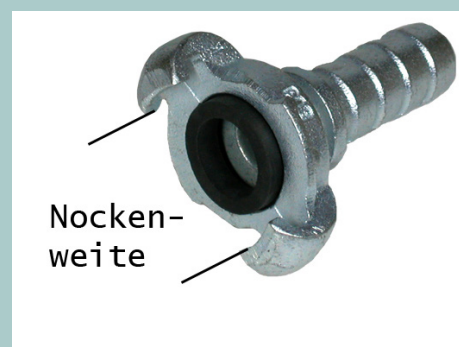
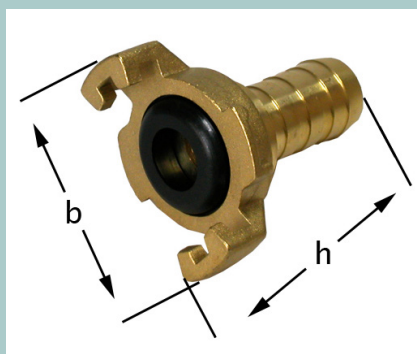

Schlauchkupplungen DIN 3489

hose couplings DIN 3489



mit Doppelnocken, **Nockenweite 42 mm**, Gummidichtung ölbeständig

Werkstoff: Kugelgraphitguss, verzinkt

Betriebsdruck: 10 bar

with double lock, **distance between lugs 42 mm**, oil-resistant rubber gasket

material: ductile graphite iron, galvanized

working pressure: 10 bar

für Schlauch Innen-Ø for hose internal-Ø mm	Breite (b) width (b) mm	Höhe (h) height (h) mm	Art.-Nr.
6	62	68,5	330 01 06 42
8	62	67,5	330 01 08 42
10	62	74,5	330 01 10 42
13	62	77,5	330 01 13 42
15	62	82,5	330 01 15 42
19	62	73	330 01 19 42
25	62	70	330 01 25 42
32	62	90	330 01 32 42

Schlauchkupplungen mit Sicherungsbund

hose couplings with retaining collar



mit Doppelnocken, **Nockenweite 42 mm**, Gummidichtung ölbeständig

Werkstoff: Kugelgraphitguss, verzinkt

Betriebsdruck: 10 bar

with double lock, **distance between lugs 42 mm**, oil-resistant rubber gasket

material: ductile graphite iron, galvanized

working pressure: 10 bar

für Schlauch Innen-Ø for hose internal-Ø mm	Breite (b) width (b) mm	Höhe (h) height (h) mm	Art.-Nr.
13	62	76	330 02 13 42
15	62	76	330 02 15 42
19	62	85	330 02 19 42
25	62	85	330 02 25 42

Schlauchkupplungen mit Sicherungsbund u. Bohrungen f. Sicherungssplinte

hose couplings with retaining collar and holes for retaining pins



mit Doppelnocken, **Nockenweite 42 mm**, Gummidichtung ölbeständig

Werkstoff: Kugelgraphitguss, verzinkt

Betriebsdruck: 10 bar

with double lock, **distance between lugs 42 mm**, oil-resistant rubber gasket

material: ductile graphite iron, galvanized

working pressure: 10 bar

für Schlauch Innen-Ø for hose internal-Ø mm	Breite (b) width (b) mm	Höhe (h) height (h) mm	Art.-Nr.
13	62	75	330 05 13 42
19	62	75	330 05 19 42
25	62	85	330 05 25 42

Innengewindekupplungen DIN 3489

female couplings DIN 3489

mit Doppelnocken, **Nockenweite 42 mm**, Gummidichtung ölbeständig
Werkstoff: Kugelgraphitguss, verzinkt
Betriebsdruck: 10 bar
 with double lock, **distance between lugs 42 mm**, oil-resistant rubber gasket
material: ductile graphite iron, galvanized
working pressure: 10 bar



Innengewinde female thread	Schlüsselweite width across flats mm	Breite (b) width (b) mm	Höhe (h) height (h) mm	Art.-Nr.
R 1/4"	22	62	35	330 03 32 42
R 3/8"	22	62	35	330 03 33 42
R 1/2"	28	62	46	330 03 34 42
R 3/4"	32	62	40	330 03 36 42
R 1"	41	62	42	330 03 37 42
R 1 1/2"	49	62	57	330 03 38 42

Innengewindekupplungen mit Bohrungen für Sicherungssplinte

female couplings with holes for retaining pins

mit Doppelnocken, **Nockenweite 42 mm**, Gummidichtung ölbeständig
Werkstoff: Kugelgraphitguss, verzinkt
Betriebsdruck: 10 bar
 with double lock, **distance between lugs 42 mm**, oil-resistant rubber gasket
material: ductile graphite iron, galvanized
working pressure: 10 bar



Innengewinde female thread	Schlüsselweite width across flats mm	Breite (b) width (b) mm	Höhe (h) height (h) mm	Art.-Nr.
R 1/2"	28	62	46	330 05 34 42
R 3/4"	32	62	40	330 05 36 42
R 1"	41	62	42	330 05 37 42

Außengewindekupplungen DIN 3489

male couplings DIN 3489

mit Doppelnocken, **Nockenweite 42 mm**, Gummidichtung ölbeständig
Werkstoff: Kugelgraphitguss, verzinkt
Betriebsdruck: 10 bar
 with double lock, **distance between lugs 42 mm**, oil-resistant rubber gasket
material: ductile graphite iron, galvanized
working pressure: 10 bar



Außengewinde male thread	Schlüsselweite width across flats mm	Breite (b) width (b) mm	Höhe (h) height (h) mm	Art.-Nr.
G 1/4"	27	62	49	330 04 32 42
G 3/8"	27	62	51	330 04 33 42
G 1/2"	27	62	53	330 04 34 42
G 3/4"	32	62	55	330 04 36 42
G 1"	39	62	53	330 04 37 42
G 1 1/4"	46	62	53	330 04 38 42

Außengewindekupplungen mit Bohrungen für Sicherungsplinte

male couplings with holes for retaining pins



mit Doppelnocken, **Nockenweite 42 mm**, Gummidichtung ölbeständig

Werkstoff: Kugelgraphitguss, verzinkt

Betriebsdruck: 10 bar

with double lock, **distance between lugs 42 mm**, oil-resistant rubber gasket

material: ductile graphite iron, galvanized

working pressure: 10 bar

Außengewinde male thread	Schlüsselweite width across flats mm	Breite (b) width (b) mm	Höhe (h) height (h) mm	Art.-Nr.
G 1/2"	27	62	53	330 06 34 42
G 3/4"	32	62	55	330 06 36 42
G 1"	39	62	53	330 06 37 42

Verschlusskupplungen DIN 3489

end caps DIN 3489



mit Doppelnocken, **Nockenweite 42 mm**, Gummidichtung ölbeständig

Werkstoff: Kugelgraphitguss, verzinkt

Betriebsdruck: 10 bar

with double lock, **distance between lugs 42 mm**, oil-resistant rubber gasket

material: malleable iron, galvanized

working pressure: 10 bar

Ausführung construction	Breite (b) width (b) mm	Höhe (h) height (h) mm	Art.-Nr.
ohne Kette/without chain	62	43	330 04 90 42
mit Kette/with chain	62	43	330 04 91 42

Dichtungen NBR

gaskets NBR

Dichtung DIN 3489 ölbeständig

Temperaturbereich: -20°C bis +100°C

oil-resistant gasket

temperature range: -20°C to +100°C

Außen-Ø outside-Ø mm	Innen-Ø inside-Ø mm	Höhe height mm	Art.-Nr.
34	20	11	330 04 93 42



Dichtungen Silikon

gaskets silicone

Dichtung dampfbeständig

Temperaturbereich: -50°C bis +140°C

steam-resistant gasket

temperature range: -50°C to +140°C

Außen-Ø outside-Ø mm	Innen-Ø inside-Ø mm	Höhe height mm	Art.-Nr.
34	20	11	330 04 94 42



Ketten für Verschlusskupplung

chains for end coupling

Bezeichnung

description

Kette für Verschlusskupplung/chain for end coupling

Art.-Nr.

330 04 95 00



Federsplinte DIN 11024 zur Sicherung

retaining pins DIN 11024 for locking

Bezeichnung

description

Federsplint/retaining pin

Art.-Nr.

330 06 90 00



Schlauchkupplungen DIN 3238 mit Bohrungen für Sicherungssplinte male couplings DIN 3238 with holes for retaining pins



Nockenweite 42 mm, Gummidichtung ölbeständig
Werkstoff: Kugelgraphitguss, verzinkt
Betriebsdruck: 16 bar
distance between lugs 42 mm, oil-resistant rubber gasket
material: ductile graphite iron, galvanized
working pressure: 16 bar

für Schlauch Innen-Ø for hose internal-Ø mm	Breite (b) width (b) mm	Höhe (h) height (h) mm	Art.-Nr.
10	63	86	330 07 10 42
13	63	86	330 07 13 42
15	63	86	330 07 15 42
19	63	86	330 07 19 42
25	63	86	330 07 25 42

Schlauchkupplungen DIN 3238 mit Rändelmutter für Hydraulikeinband hose couplings DIN 3238 with milled ring for hydraulic crimping



Nockenweite 42 mm, Gummidichtung ölbeständig
Werkstoff: Kugelgraphitguss, verzinkt
Betriebsdruck: 16 bar
distance between lugs 42 mm, oil-resistant rubber gasket
material: ductile graphite iron, galvanized
working pressure: 16 bar

für Schlauch Innen-Ø for hose internal-Ø mm	Breite (b) width (b) mm	Höhe (h) height (h) mm	Art.-Nr.
19	63	91	330 07 20 42

Innengewindekupplungen DIN 3238 mit Rändelmutter female couplings DIN 3238 with milled ring

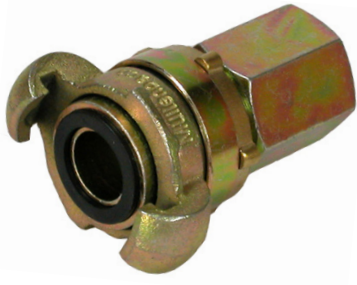

Nockenweite 42 mm, Gummidichtung ölbeständig
Werkstoff: Kugelgraphitguss, verzinkt
Betriebsdruck: 16 bar
distance between lugs 42 mm, oil-resistant rubber gasket
material: ductile graphite iron, galvanized
working pressure: 16 bar

Innengewinde female thread	Breite (b) width (b) mm	Höhe (h) height (h) mm	Art.-Nr.
R 3/8"	63	52,5	330 07 33 42
R 1/2"	63	52,5	330 07 34 42
R 3/4"	63	90	330 07 36 42
R 1"	63	96	330 07 37 42

Außengewindekupplungen DIN 3238 mit Rändelmutter male couplings DIN 3238 with milled ring

Nockenweite 42 mm, Gummidichtung ölbeständig
Werkstoff: Kugelgraphitguss, verzinkt
Betriebsdruck: 16 bar
distance between lugs 42 mm, oil-resistant rubber gasket
material: ductile graphite iron, galvanized
working pressure: 16 bar



Außengewinde male thread	Breite (b) width (b) mm	Höhe (h) height (h) mm	Art.-Nr.
G 3/8"	63	62	330 08 33 42
G 1/2"	63	64	330 08 34 42
G 3/4"	63	64	330 08 36 42
G 1"	63	80	330 08 37 42

Dichtungen NBR gaskets NBR

Dichtung ölbeständig
Temperaturbereich: -20°C bis +100°C
oil-resistant gasket
temperature range: -20°C to +100°C



Außen-Ø outside-Ø mm	Innen-Ø inside-Ø mm	Höhe height mm	Art.-Nr.
30	21	4	330 08 90 42

Dichtungen Silikon gaskets silicone

Dichtung dampfbeständig
Temperaturbereich: -50°C bis +140°C
steam-resistant gasket
temperature range: -50°C to +140°C



Außen-Ø outside-Ø mm	Innen-Ø inside-Ø mm	Höhe height mm	Art.-Nr.
30	21	4	330 08 91 42

Schlauchkupplungen mit Messingdichtung

hose couplings with brass gaskets



mit Doppelnocken, **Nockenweite 42 mm**, mit Schlauchring, ölbeständig, mit Halteschraube
Werkstoff: Kugelgraphitguss, verzinkt
Betriebsdruck: 10 bar
 with double lock, **distance between lugs 42 mm**, oil-resistant hose ring, holding screw
material: ductile graphite iron, galvanized
working pressure: 10 bar

für Schlauch Innen-Ø for hose internal-Ø mm	Breite (b) width (b) mm	Höhe (h) height (h) mm	Art.-Nr.
10	62	83	330 09 10 42
13	62	78	330 09 13 42
15	62	82	330 09 15 42
19	62	82	330 09 19 42
25	62	87	330 09 25 42

Innengewindekupplungen mit Messingdichtung

female couplings with brass gasket

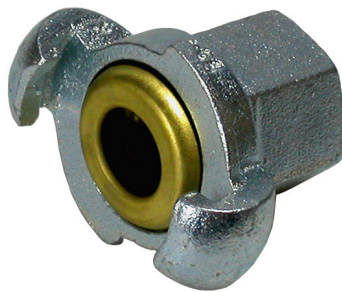

mit Doppelnocken, **Nockenweite 42 mm**, mit Schlauchring, ölbeständig, mit Halteschraube
Werkstoff: Kugelgraphitguss, verzinkt
Betriebsdruck: 10 bar
 with double lock, **distance between lugs 42 mm**, oil-resistant hose ring, holding screw
material: ductile graphite iron, galvanized
working pressure: 10 bar

Innengewinde female thread	Schlüsselweite width across flats mm	Breite (b) width (b) mm	Höhe (h) height (h) mm	Art.-Nr.
R 1/2"	28	62	46	330 09 34 42
R 3/4"	32	62	50	330 09 36 42
R 1"	38	62	51	330 09 37 42
Rd 32 x 1/8"	39	62	53	330 09 81 42

Außengewindekupplungen mit Messingdichtung

male couplings with brass gasket



mit Doppelnocken, **Nockenweite 42 mm**, mit Schlauchring, ölbeständig, mit Halteschraube
Werkstoff: Kugelgraphitguss, verzinkt
Betriebsdruck: 10 bar
 with double lock, **distance between lugs 42 mm**, oil-resistant hose ring, holding screw
material: ductile graphite iron, galvanized
working pressure: 10 bar

Außengewinde male thread	Schlüsselweite width across flats mm	Breite (b) width (b) mm	Höhe (h) height (h) mm	Art.-Nr.
G 1/2"	27	62	53	330 10 34 42
G 3/4"	32	62	55	330 10 36 42
G 1"	39	62	53	330 10 37 42

Messinghülsen

brass gasket

Außen-Ø outside-Ø mm	Innen-Ø inside-Ø mm	Höhe height mm
32	17	21

Art.-Nr.

330 10 90 42



Schlauchringe für Messingdichtung

hose rings for brass gasket

Außen-Ø outside-Ø mm	Innen-Ø inside-Ø mm	Höhe height mm
30	23	10

Art.-Nr.

330 10 91 42



Halteschrauben

holding screws

Gewinde
thread

M 5 X 13

Art.-Nr.

330 10 92 42



Schlauchkupplungen aus Messing mit Sicherungsbund

hose couplings from brass with retaining collar



Nockenweite 42 mm, Gummidichtung ölbeständig

Werkstoff: Pressmessing MS 58

Betriebsdruck: 10 bar

distance between lugs 42 mm, oil-resistant rubber gasket

material: forged brass MS 58

working pressure: 10 bar

für Schlauch Innen-Ø for hose internal-Ø mm	Breite (b) width (b) mm	Höhe (h) height (h) mm	Art.-Nr.
10	57	69	330 11 10 42
13	57	69	330 11 43 42
15	57	69	330 11 15 42
19	57	69	330 11 19 42
25	57	69	330 11 25 42

Innengewindekupplungen aus Messing

female couplings from brass



Nockenweite 42 mm, Gummidichtung ölbeständig

Werkstoff: Pressmessing MS 58

Betriebsdruck: 10 bar

distance between lugs 42 mm, oil-resistant rubber gasket

material: forged brass MS 58

working pressure: 10 bar

Innengewinde female thread	Schlüsselweite width across flats mm	Breite (b) width (b) mm	Höhe (h) height (h) mm	Art.-Nr.
R 3/8"	21	57	31,5	330 11 33 42
R 1/2"	26	57	33	330 11 34 42
R 3/4"	32	57	35,5	330 11 36 42
R 1"	37	57	36,5	330 11 37 42

Außengewindekupplungen aus Messing

male couplings from brass



Nockenweite 42 mm, Gummidichtung ölbeständig

Werkstoff: Pressmessing MS 58

Betriebsdruck: 10 bar

distance between lugs 42 mm, oil-resistant rubber gasket

material: forged brass MS 58

working pressure: 10 bar

Außengewinde male thread	Schlüsselweite width across flats mm	Breite (b) width (b) mm	Höhe (h) height (h) mm	Art.-Nr.
G 3/8"	19	57	39	330 12 33 42
G 1/2"	24	57	41	330 12 34 42
G 3/4"	30	57	41	330 12 36 42
G 1"	34	57	39	330 12 37 42

Verschlusskupplungen end caps

Nockenweite 42 mm, Gummidichtung ölbeständig
Werkstoff: Pressmessing MS 58
Betriebsdruck: 10 bar
distance between lugs 42 mm, oil-resistant rubber gasket
material: forged brass MS 58
working pressure: 10 bar



Ausführung construction	Breite (b) width (b) mm	Höhe (h) height (h) mm	Art.-Nr.
ohne Kette/without chain	57	31	330 12 90 42

Schlauchkupplungen mit Sicherungsbund u. Bohrungen für Sicherungssplinte hose couplings with retaining collar and holes for retaining pins



US-Ausführung

Nockenweite 41 mm, Gummidichtung ölbeständig

Werkstoff: Kugelgraphitguss, verzinkt

Betriebsdruck: 10 bar

US-type

distance between lugs 41 mm, oil-resistant rubber gasket

material: ductile graphite iron, galvanized

working pressure: 10 bar

für Schlauch Innen-Ø for hose internal-Ø mm	Breite (b) width (b) mm	Höhe (h) height (h) mm	Art.-Nr.
10	62	77	330 13 10 41
13	62	90	330 13 13 41
19	62	104	330 13 19 41
25	62	108	330 13 25 41

Innengewindekupplungen mit Bohrungen für Sicherungssplinte female couplings with holes for retaining pins



US-Ausführung

Nockenweite 41 mm, Gummidichtung ölbeständig

Werkstoff: Kugelgraphitguss, verzinkt

Betriebsdruck: 10 bar

US-type

distance between lugs 41 mm, oil-resistant rubber gasket

material: ductile graphite iron, galvanized

working pressure: 10 bar

Innengewinde female thread	Schlüsselweite width across flats mm	Breite (b) width (b) mm	Höhe (h) height (h) mm	Art.-Nr.
R 3/8"	27	62	57	330 13 83 41
R 1/2"	27	62	57	330 13 84 41
R 3/4"	35	62	57	330 13 85 41
R 1"	42	62	57	330 13 86 41

Außengewindekupplungen mit Bohrungen für Sicherungssplinte male couplings with holes for retaining pins



US-Ausführung

Nockenweite 41 mm, Gummidichtung ölbeständig

Werkstoff: Kugelgraphitguss, verzinkt

Betriebsdruck: 10 bar

US-type

distance between lugs 41 mm, oil-resistant rubber gasket

material: ductile graphite iron, galvanized

working pressure: 10 bar

Außengewinde male thread	Schlüsselweite width across flats mm	Breite (b) width (b) mm	Höhe (h) height (h) mm	Art.-Nr.
G 3/8"	29	62	64	330 14 83 41
G 1/2"	29	62	64	330 14 84 41
G 3/4"	34	62	70	330 14 85 41
G 1"	38	62	73	330 14 86 41

Dichtungen NBR

gaskets NBR

Dichtung DIN 3489 ölbeständig

Temperaturbereich: -20°C bis +100°C

oil-resistant gasket

temperature range: -20°C to +100°C

Außen-Ø outside-Ø mm	Innen-Ø inside-Ø mm	Höhe height mm	Art.-Nr.
34	20	11	330 04 93 42



Dichtungen Silikon

gaskets silicone

Dichtung dampfbeständig

Temperaturbereich: -50°C bis +140°C

steam-resistant gasket

temperature range: -50°C to +140°C

Außen-Ø outside-Ø mm	Innen-Ø inside-Ø mm	Höhe height mm	Art.-Nr.
34	20	11	330 04 94 42



Federsplinte DIN 11024 zur Sicherung

retaining pins DIN 11024 for locking

Bezeichnung description	Art.-Nr.
Federsplint/retaining pin	330 06 90 00



Notizen/notes

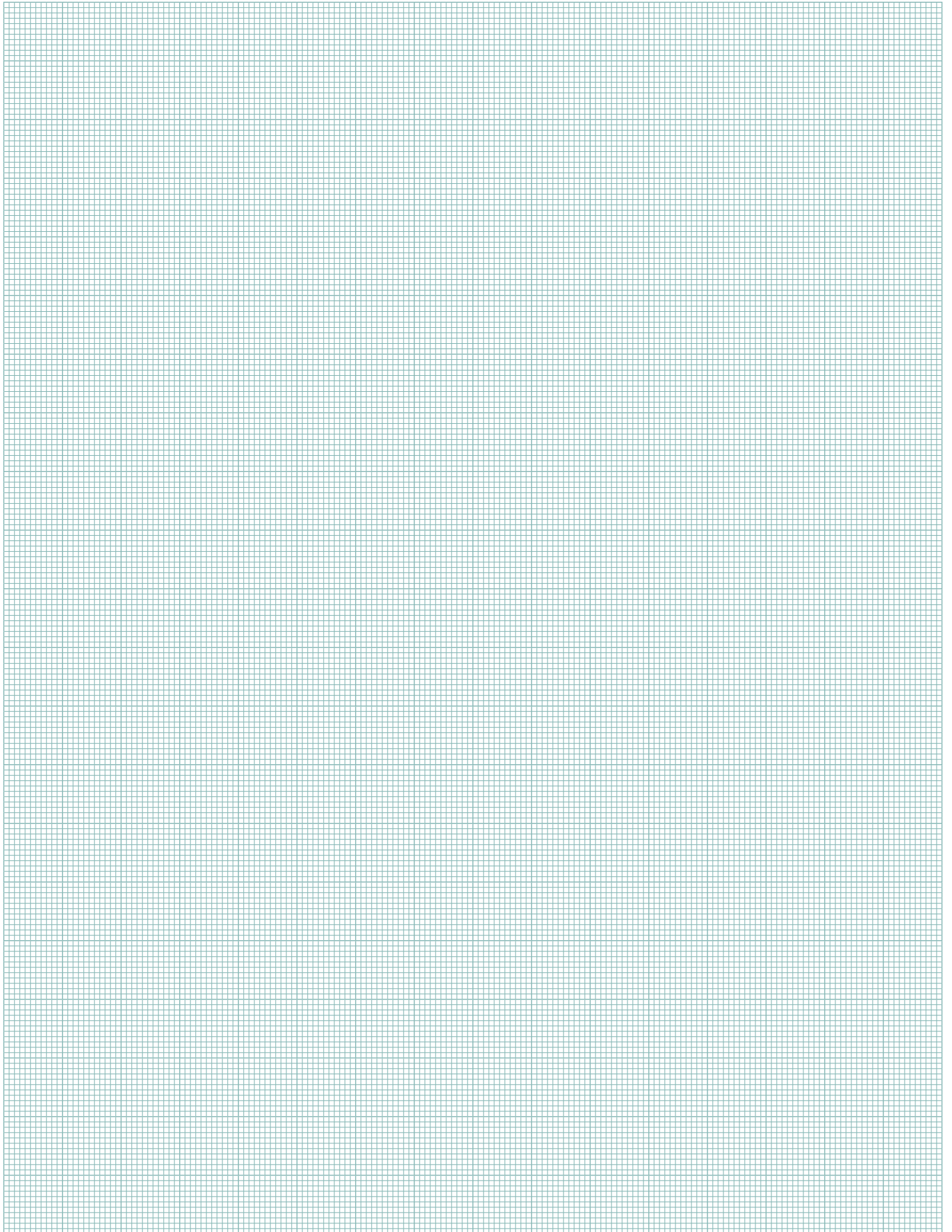

Klauenkupplungen, Spritzdüsen und Auslaufventile für Wasser

Claw couplings, nozzles and taps for water

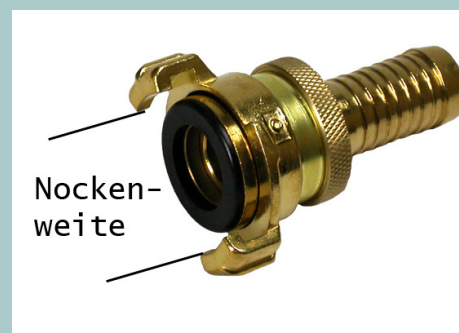
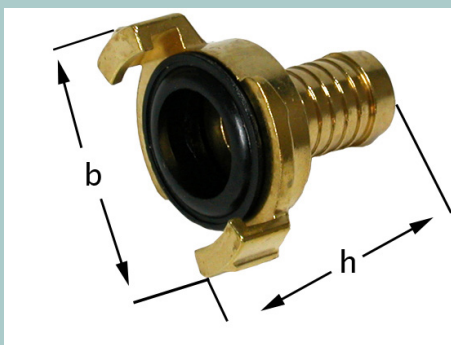

Schlauchkupplungen aus Messing für Wasser

hose couplings from brass for water



Nockenweite 40 mm, Dichtung aus Perbunan
Werkstoff: Pressmessing MS 58
distance between lugs 40 mm, gasket from Perbunan
material: forged brass MS 58

für Schlauch Innen-Ø for hose internal-Ø mm	Breite (b) width (b) mm	Höhe (h) height (h) mm	Art.-Nr.
10	55	46,5	330 15 10 40
13	55	51	330 15 13 40
16	55	51	330 15 16 40
19	55	54,5	330 15 19 40
25	55	62	330 15 25 40
32	55	70	330 15 32 40
38	55	79	330 15 38 40

Schlauchkupplungen aus Messing für Wasser - mit Nachstellring

hose couplings from brass for water - with adjustment ring



Nockenweite 40 mm, Dichtung aus Perbunan
Werkstoff: Pressmessing MS 58
distance between lugs 40 mm, gasket from Perbunan
material: forged brass MS 58

für Schlauch Innen-Ø for hose internal-Ø mm	Breite (b) width (b) mm	Höhe (h) height (h) mm	Art.-Nr.
13	57	74	330 17 13 40
19	57	78,5	330 17 19 40
25	57	80	330 17 25 40
32	57	87	330 17 32 40

Schlauchkupplungen aus Messing für Wasser - 360° axial drehbar

hose couplings from brass for water - 360° rotatable



Nockenweite 40 mm, Dichtung aus Perbunan
Werkstoff: Pressmessing MS 58
distance between lugs 40 mm, gasket from Perbunan
material: forged brass MS 58

für Schlauch Innen-Ø for hose internal-Ø mm	Breite (b) width (b) mm	Höhe (h) height (h) mm	Art.-Nr.
10	57	36	330 18 13 40
19	57	68	330 18 19 40
25	57	77	330 18 25 40

Innengewindekupplungen aus Messing für Wasser

female couplings from brass for water

Nockenweite 40 mm, Dichtung aus Perbunan
Werkstoff: Pressmessing MS 58
distance between lugs 40 mm, gasket from Perbunan
material: forged brass MS 58

Innengewinde female thread	Breite (b) width (b) mm	Höhe (h) height (h) mm	Art.-Nr.
R 1/4"	52	33	330 21 32 40
R 3/8"	55	33,5	330 21 33 40
R 1/2"	55	35	330 21 34 40
R 3/4"	55	32	330 21 36 40
R 1"	55	36	330 21 37 40
R 1 1/4"	55	40	330 21 38 40
R 1 1/2"	55	38	330 21 39 40



Außengewindekupplungen aus Messing für Wasser

male couplings from brass for water

Nockenweite 40 mm, Dichtung aus Perbunan
Werkstoff: Pressmessing MS 58
distance between lugs 40 mm, gasket from Perbunan
material: forged brass MS 58

Außengewinde male thread	Breite (b) width (b) mm	Höhe (h) height (h) mm	Art.-Nr.
G 1/4"	52	33	330 16 32 40
G 3/8"	55	33,5	330 16 33 40
G 1/2"	55	34	330 16 34 40
G 3/4"	55	33	330 16 36 40
G 1"	55	33	330 16 37 40
G 1 1/4"	55	41	330 16 38 40
G 1 1/2"	55	39	330 16 39 40



Verschlusskupplungen

end caps

Nockenweite 40 mm Dichtung aus Perbunan
Werkstoff: Pressmessing MS 58
distance between lugs 40 mm, gasket from Perbunan
material: forged brass MS 58

Ausführung construction	Breite (b) width (b) mm	Höhe (h) height (h) mm	Art.-Nr.
ohne Kette/without chain	55	35	330 16 90 40



Schlauchkupplungen aus Messing für Wasser

hose couplings from brass for water



Werkstoff: Pressmessing MS 58

material: forged brass MS 58

Eingang Innengewinde inlet female thread	Ausgang Außengewinde outlet internal thread	Breite (b) width (b) mm	Höhe (h) height (h) mm	Art.-Nr.
R 3/4"	2 x G 3/4"	57	50	330 18 80 00

Dichtungen NBR

gaskets NBR



Außen-Ø outside-Ø mm	Innen-Ø inside-Ø mm	Höhe height mm	Art.-Nr.
37,5	22	12	330 16 91 40

Dichtungen Perbunan für Schlauchkupplungen mit Nachstellring

gaskets Perbunan for hose couplings with adjustment ring



Außen-Ø outside-Ø mm	Innen-Ø inside-Ø mm	Höhe height mm	Art.-Nr.
34	20,5	7	330 18 80 01

Spritzdüsen mit drehbarem Kopf - absperrrbar

hose nozzles with adjustable head - with lock-off

für Vollstrahl, Brause, Sprühregen und Absperrung

Werkstoff: Messing

full jet, spray, or shut-off

material: brass

für Schlauch Innen-Ø for hose internal-Ø mm	Breite (b) width (b) mm	Höhe (h) height (h) mm	Art.-Nr.
13	32	65	330 18 81 13
19	36	65	330 18 81 19



Spritzdüsen mit drehbarem Kopf / Schlauchanschluss

hose nozzles with adjustable head / hose connector

für Vollstrahl, Brause, Sprühregen ohne Absperrung

Werkstoff: Messing

full jet, spray, without shut-off

material: brass

für Schlauch Innen-Ø for hose internal-Ø mm	Breite (b) width (b) mm	Höhe (h) height (h) mm	Art.-Nr.
13	18	64	330 18 82 13
19	19	70	330 18 82 19



Spritzdüsen mit drehbarem Kopf / Klauenkupplung

hose nozzles with adjustable head / claw coupling

für Vollstrahl, Brause, Sprühregen und Absperrung

mit Wasserkupplung für **Nockenweite 40 mm**

Werkstoff: Messing

full jet, spray, without shut-off

with water coupling for **distance between lugs 40 mm**

material: brass

Breite (b) width (b) mm	Höhe (h) height (h) mm	Art.-Nr.
58	78	330 18 83 34
58	97	330 18 83 36
58	87	330 18 83 37



Auslaufventile mit Schlauchverschraubung

water taps with hose connector



matt verchromt

Werkstoff: Pressmessing MS 58

matte chromium plated

material: forged brass MS 58

Eingang Außengewinde inlet male thread	Ausgang Schlüsselweite outlet width across flats mm	Breite (b) width (b) mm	Höhe (h) height (h) mm	Art.-Nr.
G 1/2"	19	120	132	330 18 84 34
G 3/4"	19	127	150	330 18 84 36

Kugel-Auslaufventile mit Schlauchverschraubung

ball water taps with hose connector



matt verchromt, Dichtung aus Teflon

matte chromium plated, gasket from Teflon

Eingang Außengewinde inlet male thread	Ausgang Schlüsselweite outlet width across flats mm	Breite (b) width (b) mm	Höhe (h) height (h) mm	Art.-Nr.
G 1/2"	13	105	90	330 18 85 34
G 3/4"	19	120	105	330 18 85 36

Schlauchkupplungen aus Edelstahl

hose couplings from stainless steel

Nockenweite 40 mm, Dichtung aus Viton

Werkstoff: Edelstahl, ähnlich 1.4571

with double lock, **distance between lugs 40 mm**, gasket from Viton

material: stainless steel, similar to 1.4571

für Schlauch Innen-Ø for hose internal-Ø mm	Breite (b) width (b) mm	Höhe (h) height (h) mm	Art.-Nr.
13	53	50	330 19 13 40
19	53	53	330 19 19 40
25	53	57	330 19 25 40



Innengewindekupplungen aus Edelstahl

female couplings from stainless steel

Nockenweite 40 mm, Dichtung aus Viton

Werkstoff: Edelstahl, ähnlich 1.4571

with double lock, **distance between lugs 40 mm**, gasket from Viton

material: stainless steel, similar to 1.4571

Innengewinde female thread	Breite (b) width (b) mm	Höhe (h) height (h) mm	Art.-Nr.
R 1/2"	53	31	330 19 34 40
R 3/4"	53	32	330 19 36 40
R 1"	53	32	330 19 37 40

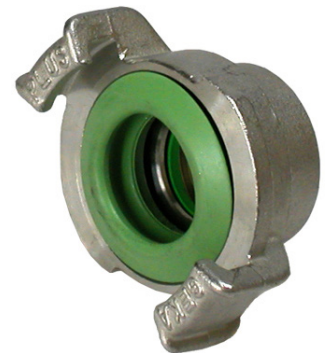

Außengewindekupplungen aus Edelstahl

male couplings from stainless steel

Nockenweite 40 mm, Dichtung aus Viton

Werkstoff: Edelstahl, ähnlich 1.4571

with double lock, **distance between lugs 40 mm**, gasket from Viton

material: stainless steel, similar to 1.4571

Außengewinde external thread	Breite (b) width (b) mm	Höhe (h) height (h) mm	Art.-Nr.
G 1/2"	53	32	330 20 34 40
G 3/4"	53	32	330 20 36 40
G 1"	53	32	330 20 37 40



Verschlusskupplungen aus Edelstahl

end caps from stainless steel



Nockenweite 42 mm, Dichtung aus Viton

Werkstoff: Edelstahl, ähnlich 1.4571

with double lock, **distance between lugs 42 mm**, gasket from Viton

material: stainless steel, similar to 1.4571

Ausführung construction	Breite (b) width (b) mm	Höhe (h) height (h) mm	Art.-Nr.
ohne Kette/without chain	55	35	330 20 90 01

Dichtungen Silikon

gaskets silicone



Außen-Ø outside-Ø mm	Innen-Ø inside-Ø mm	Höhe height mm	Art.-Nr.
33	20	10,5	330 20 90 02

Kugelhähne und Ventile

Ball valves and check valves



Doppelkugelhähne

double ball valves



mit Hebelanschlag und Entlüftung
Werkstoff: Stahl, verzinkt, Kugel aus Messing
Betriebsdruck: 10 bar
 with lever stop and exhaust
material: steel, galvanized, ball from brass
working pressure: 10 bar

Eingang Innengewinde inlet female thread	Ausgang Außengewinde outlet male thread	Art.-Nr.
R 3/4"	G 3/4"	333 01 10 36
R 1"	G 3/4"	333 01 10 37

Doppelkugelhähne

double ball valves



mit Hebelanschlag und Entlüftung, Kupplungen mit Gummidichtung
Werkstoff: Stahl, verzinkt, Kugel aus Messing
Betriebsdruck: 10 bar
 with lever stop and exhaust, couplings with rubber gasket
material: steel, galvanized, ball from brass
working pressure: 10 bar

Eingang Innengewinde inlet female thread	Ausgang Kuppung outlet couplings	Art.-Nr.
R 3/4"	330 03 36 42	333 01 10 46
R 1"	330 03 36 42	333 01 10 47

Doppelkugelhähne

double ball valves



mit Hebelanschlag und Entlüftung, Kupplungen mit Metalldichtung
Werkstoff: Stahl, verzinkt, Kugel aus Messing
Betriebsdruck: 10 bar
 with lever stop and exhaust, couplings with brass gasket
material: steel, galvanized, ball from brass
working pressure: 10 bar

Eingang Innengewinde inlet female thread	Ausgang Kuppung outlet couplings	Art.-Nr.
R 3/4"	330 09 36 42	333 01 10 56
R 1"	330 03 36 42	333 01 10 57

Bohrhammer-Kugelhähne mit beiderseits Außengewinde airhammer ball valves with male thread on both ends

mit Hebelanschlag ohne Entlüftung

Werkstoff: Stahl, verzinkt, Kugel aus Messing

Betriebsdruck: 25 bar

with lever stop, without exhaust

material: steel, galvanized, ball from brass

working pressure: 25 bar

Eingang inlet	Ausgang outlet	Konus cone	Art.-Nr.
G 3/4"	G 3/4"	1:4	333 02 36 36
G 3/4"	Rd 32X1/8"	1:3	333 02 36 32
G 1"	Rd 32X1/8"	1:3	333 02 37 32
G 1"	G 1"	1:3	333 02 37 37
G 1"	Rd 38X1/8"	1:3	333 02 37 38
G 2"	Rd 75X1/6"	1:3	333 02 40 75



Einfach-Kugelhähne single ball valves

mit Hebelanschlag und Entlüftung

Werkstoff: Stahl, verzinkt, Kugel aus Messing

Betriebsdruck: 10 bar

with lever stop and exhaust

material: steel, galvanized, ball from brass

working pressure: 10 bar

Eingang Innengewinde inlet female thread	Ausgang Außengewinde outlet male thread	Art.-Nr.
R 3/4"	G 3/4"	333 04 36 36
R 1"	G 3/4"	333 04 37 37



Einfach-Kugelhähne single ball valves

mit Hebelanschlag und Entlüftung, Kupplung mit Gummidichtung

Werkstoff: Stahl, verzinkt, Kugel aus Messing

Betriebsdruck: 10 bar

with lever stop and exhaust, coupling with rubber gasket

material: steel, galvanized, ball from brass

working pressure: 10 bar

Eingang Innengewinde inlet female thread	Ausgang Kuppung outlet couplings	Art.-Nr.
R 3/4"	330 03 36 42	333 04 36 46
R 1"	330 03 36 42	333 04 36 47



Einfach-Kugelhähne

single ball valves



mit Hebelanschlag und Entlüftung, Kupplung mit Metalledichtung

Werkstoff: Stahl, verzinkt, Kugel aus Messing

Betriebsdruck: 10 bar

with lever stop and exhaust, coupling with brass gasket

material: steel, galvanized, ball from brass

working pressure: 10 bar

Eingang Innengewinde inlet female thread	Ausgang Kuppung outlet couplings	Art.-Nr.
R 3/4"	330 09 36 42	333 04 36 56
R 1"	330 09 36 42	333 04 36 57

Rückschlag- und Fußventile

Check and foot valves



Rückschlagventile „Europa“

check valves "Europa"



mit beidseitigem Innengewinde

Werkstoff: Gehäuse Messing, Ventil und Feder Edelstahl, Dichtung NBR
with female thread on both ends

material: housing brass, valve and spring stainless steel, gasket NBR

Gewinde thread	Betriebsdruck working pressure bar	Breite width mm	Gesamtlänge total length mm	Art.-Nr.
R 3/8"	25	34,5	54	333 05 33 00
R 1/2"	25	34,5	57	333 05 34 00
R 3/4"	25	41,5	64	333 05 36 00
R 1"	25	48	75	333 05 37 00
R 1 1/4"	18	60,5	82	333 05 38 00
R 1 1/2"	18	71	93	333 05 39 00
R 2"	18	87	100	333 05 40 00
R 2 1/2"	12	120	120	333 05 41 00
R 3"	12	140	140	333 05 42 00
R 4"	12	172	158	333 05 43 00

Fußventile „Europa“

foot valves "Europa"

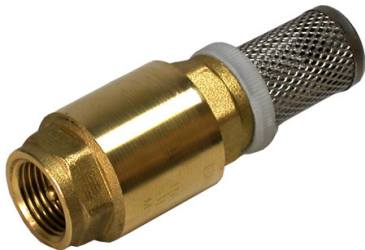

mit einerseits Innengewinde und andererseits Filtersieb

Werkstoff: Gehäuse Messing, Filtersieb, Ventil und Feder Edelstahl, Dichtung NBR
with female thread on one end and filter mesh at the other

material: housing brass, filter mesh, valve and spring stainless steel, gasket NBR

Gewinde thread	Betriebsdruck working pressure bar	Breite width mm	Gesamtlänge total length mm	Art.-Nr.
R 3/8"	25	34,5	91	333 06 33 00
R 1/2"	25	34,5	95,5	333 06 34 00
R 3/4"	25	41,5	113	333 06 36 00
R 1"	25	48	133	333 06 37 00
R 1 1/4"	18	60,5	146	333 06 38 00
R 1 1/2"	18	71	166	333 06 39 00
R 2"	18	87	187	333 06 40 00
R 2 1/2"	12	120	228	333 06 41 00
R 3"	12	140	263	333 06 42 00
R 4"	12	172	296	333 06 43 00

Schmutzfänger filtering valve

mit beidseitigem Innengewinde

Werkstoff: Gehäuse Messing, Sieb Edelstahl, Dichtung NBR

with female thread on both ends

material: housing brass, filter stainless steel, gasket NBR



Gewinde thread	DN	Gesamtlänge total length mm	Art.-Nr.
R 1/4"	10	55	333 37 32 00
R 3/8"	10	55	333 37 33 00
R 1/2"	15	58	333 37 34 00
R 3/4"	20	70	333 37 36 00
R 1"	25	90	333 37 37 00
R 1 1/4"	32	96	333 37 38 00
R 1 1/2"	40	106	333 37 39 00
R 2"	50	126	333 37 40 00

Notizen/notes

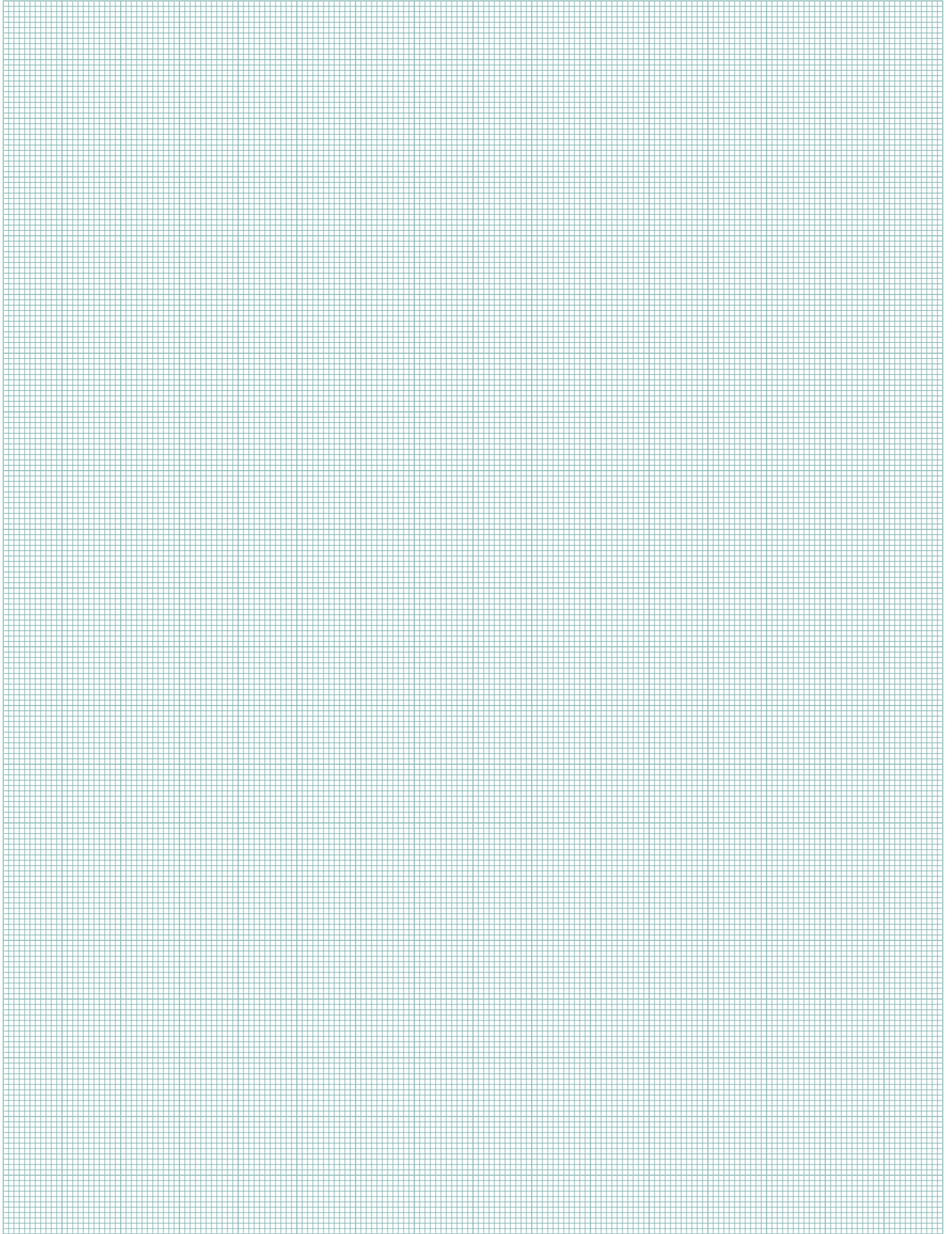

Druckluftverschraubungen und Zubehör

Compressed air connections
and accessories



Überwurfmuttern wing nuts



DIN 8537/20033
DIN 8537/20033

Werkstoff: Temperguss, verzinkt
material: malleable iron, galvanized

Innengewinde female thread	Bohrung bore mm	Gesamtlänge total length mm	Art.-Nr.
R 3/4"	21	24	333 07 36 00
R 1"	23	30	333 07 37 00
Rd 32X1/8"	23	30	333 08 32 18
Rd 38X1/8"	29	33	333 08 38 18

Kegeltüllen tapered stems



DIN 20034
DIN 20034

Werkstoff: Stahl, verzinkt
Betriebsdruck: 16 bar
material: steel, galvanized
working pressure: 16 bar

für Schlauch Innen-Ø for hose internal-Ø mm	Konus cone	Nennweite nominal size	Gesamtlänge total length mm	Art.-Nr.
15	1:4	12	74	333 09 15 00
19	1:3	15	78	333 09 19 00
25	1:3	20	105	333 09 25 00

komplette Verschraubungen mit Sicherheitsbund complete connectings with safety collar



DIN 8537/20033
DIN 8537/20033

Werkstoff: Stahl/Temperguss, verzinkt
Betriebsdruck: 16 bar
material: steel/malleable iron, galvanized
working pressure: 16 bar

für Schlauch Innen-Ø for hose internal-Ø mm	Gewinde thread	Konus cone	Nennweite nominal size	Gesamtlänge total length mm	Art.-Nr.
13	Rd 32X1/8"	1:3	12	75	333 10 13 32
15	Rd 32X1/8"	1:3	12	75	333 10 15 32
19	Rd 32X1/8"	1:3	15	85	333 10 19 32
25	Rd 38X1/8"	1:3	20	98	333 10 25 38
25	R 1"	1:3	20	90	333 10 25 37
32	Rd 46X1/6"	1:3	25	120	333 10 32 46
35	Rd 55X1/6"	1:3	30	106	333 10 35 55
38	Rd 55X1/6"	1:3	31	106	333 10 38 55
42	Rd 62X1/6"	1:3	35	158	333 10 42 62
50	Rd 75X1/6"	1:3	44	160	333 10 50 75
53	Rd 75X1/6"	1:3	44	160	333 10 53 75

Außengewindetüllen male thread stems

Werkstoff: Stahl, verzinkt
Betriebsdruck: 25 bar
material: steel, galvanized
working pressure: 25 bar

für Schlauch Innen-Ø for hose internal-Ø mm	Gewinde thread	Gesamtlänge total length mm	Schlüsselweite width across flats	Art.-Nr.
6	G 1/4"	45	17	333 40 06 32
6	G 3/8"	45	17	333 40 06 33
8	G 1/4"	49	17	333 40 08 32
8	G 3/8"	43,5	17	333 40 08 33
10	G 1/4"	45	17	333 40 10 32
10	G 3/8"	45	17	333 40 10 33
13	G 1/4"	60	19	333 40 13 32
13	G 3/8"	44	17	333 40 13 33
13	G 1/2"	65	24	333 40 13 34
15	G 1/2"	64	22	333 40 15 34
15	G 3/4"	65	22	333 40 15 36
19	G 1/2"	64	22	333 40 19 34
19	G 3/4"	70	27	333 40 19 36
19	G 1"	78	36	333 40 19 37
25	G 3/4"	70,5	32	333 40 25 36
25	G 1"	87	36	333 40 25 37
32	G 1 1/4"	90	46	333 40 32 38
38	G 1 1/2"	141	55	333 40 38 39
53	G 2"	166	65	333 40 53 40



Die Außengewindetüllen für Schlauch Innen-Ø 38 mm und 53 mm sind ohne Sechskant.
 The male thread stems for hose internal-Ø 38 mm and 53 mm are without hexagon.

Schlauchverbindungsrippel hose connecting nipples

DIN 20040
DIN 20040

Werkstoff: Stahl, verzinkt
Betriebsdruck: 25 bar
material: steel, galvanized
working pressure: 25 bar

Gewinde thread	Innenkonus inner cone	Gesamtlänge total length mm	Schlüsselweite width across flats	Art.-Nr.
G 3/4"	1:4	47	27	333 12 36 36
G 1"	1:3	55	36	333 12 37 37
Rd 32X1/8"	1:3	55	32	333 12 32 32
Rd 38X1/8"	1:3	61,5	41	333 12 38 38
Rd 46X1/6"	1:3	70,5	46	333 12 46 46
Rd 55X1/6"	1:3	75	55	333 12 55 55
Rd 62X1/6"	1:3	86	65	333 12 62 62
Rd 75X1/6"	1:3	100	75	333 12 75 75



Selbstschlussnippel

self-closing nipples



DIN 20040
DIN 20040

Werkstoff: Stahl, verzinkt
Betriebsdruck: 25 bar
material: steel, galvanized
working pressure: 25 bar

Außengewinde male thread	Außengewinde male thread	Innenkonus inner cone	Gesamtlänge total length mm	Schlüsselweite width across flats	Art.-Nr.
G 3/4"	Rd 32X1/8"	1:3	50	32	333 11 36 32

Anschlussnippel

connecting nipples



Außengewinde/Innengewinde
Werkstoff: Stahl, verzinkt
Betriebsdruck: 25 bar
male thread/female thread
material: steel, galvanized
working pressure: 25 bar

Innengewinde male thread	Außengewinde male thread	Innenkonus inner cone	Gesamtlänge total length mm	Schlüsselweite width across flats	Art.-Nr.
R 1/2"	Rd 32X1/8"	1:3	34	32	333 13 34 32
R 3/4"	Rd 32X1/8"	1:3	44	32	333 13 36 32

Anschlussnippel

connecting nipples



DIN 20037
DIN 20037

beiderseits Außengewinde
Werkstoff: Stahl, verzinkt
Betriebsdruck: 25 bar
on both sides male thread
material: steel, galvanized
working pressure: 25 bar

Einschraubgewinde screw-in thread	Anschlußgewinde connection thread	Innenkonus inner cone	Gesamtlänge total length mm	Schlüsselweite width across flats	Art.-Nr.
G 1/4"	Rd 32X1/8"	1:3	44	32	333 14 32 32
G 1/2"	G 3/4"	1:4	40	27	333 14 34 36
G 1/2"	Rd 32X1/8"	1:3	48	32	333 14 34 32
G 3/4"	Rd 32X1/8"	1:3	48	32	333 14 36 32
G 1"	Rd 32X1/8"	1:3	48	36	333 14 37 32
G 1"	Rd 38X1/8"	1:3	54	41	333 14 37 38
G 1 1/4"	Rd 46X1/6"	1:3	60	46	333 14 38 46
G 1 1/4"	Rd 55X1/6"	1:3	67,5	55	333 14 38 55
G 1 1/2"	Rd 55X1/6"	1:3	67	55	333 14 39 55
G 1 1/2"	Rd 62X1/6"	1:3	75	65	333 14 39 62
G 2"	Rd 75X1/6"	1:3	85	75	333 14 40 75

Siebniessel sieve nipples

DIN 20037
DIN 20037

beiderseits Außengewinde

Werkstoff: Stahl/Temperguss, verzinkt

Betriebsdruck: 25 bar

male thread on both ends

material: steel/malleable iron, galvanized

working pressure: 25 bar



Einschraubgewinde screw-in thread	Anschlußgewinde connection thread	Innenkonus inner cone	Gesamtlänge total length mm	Schlüsselweite width across flats	Art.-Nr.
G 1/4"	Rd 32X1/8"	1:3	45	32	333 15 33 32
G 3/4"	G 3/4"	1:4	44	27	333 15 35 35
G 3/4"	G 3/4"	1:4	44	32	333 15 36 36
G 3/4"	Rd 32X1/8"	1:3	51	32	333 15 36 32

Schlauchverbinder hose menders

Werkstoff: Messing

Betriebsdruck: 10 bar

material: brass

working pressure: 10 bar

für Schlauch Innen-Ø for hose internal-Ø mm	Nennweite nominal size	Gesamtlänge total length mm	Art.-Nr.
4	3	63	333 16 04 04
6	5	72	333 16 06 06
8	7	72	333 16 08 08
9	8	72	333 16 09 09
10	8,5	47	333 16 10 10
13	11	48	333 16 13 13
15	13,5	51	333 16 15 15
19	16	55	333 16 19 19
25	22	58	333 16 25 25



Schlauchverbinder mit Sicherheitsbund

hose menders with safety collar



DIN 20038

DIN 20038

Werkstoff: Stahl, verzinkt

Betriebsdruck: 10 bar

material: steel, galvanized

working pressure: 10 bar

für Schlauch Innen-Ø for hose internal-Ø mm	Nennweite nominal size	Gesamtlänge total length mm	Art.-Nr.
19	16	105	333 18 19 19
25	20	155	333 18 25 25
53	46	221	333 18 53 53

Schlauchverbinder

hose menders



DIN 20038

DIN 20038

Werkstoff: Stahl, verzinkt

Betriebsdruck: 10 bar

material: steel, galvanized

working pressure: 10 bar

für Schlauch Innen-Ø for hose internal-Ø mm	Nennweite nominal size	Gesamtlänge total length mm	Art.-Nr.
10	8	60	333 17 10 10
13	10	82	333 17 13 13
15	12	107	333 17 15 15
19	15	105	333 17 19 19
25	19	155	333 17 25 25
32	25	150	333 17 32 32
38	30	181	333 17 38 38
50	46	220	333 17 50 50
53	46	220	333 17 53 53

Schlauchklemmen

Malleable hose clamps

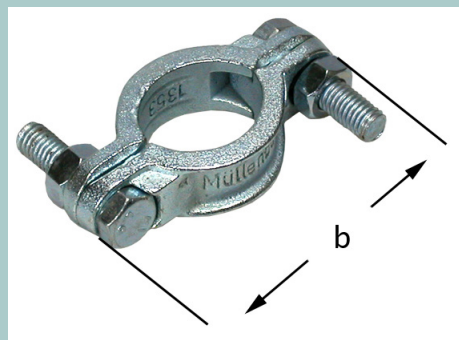

Schlauchklemmen 2-teilig

two part hose clamps



mit angegossenen Zungen

Werkstoff: Temperguss, verzinkt

Betriebsdruck: 16 bar

with casted tongues

material: malleable iron, galvanized

working pressure: 16 bar

Spannbereich clamping range mm	Breite (b) width (b) mm	Art.-Nr.
17-22	61	330 21 13 16
25-32	70	330 21 19 16

Schlauchklemmen 2-teilig DIN 20039 A

two part hose clamps DIN 20039 A



mit losen Zungen

Werkstoff: Temperguss, verzinkt

Betriebsdruck: 16 bar

with separate tongues

material: malleable iron, galvanized

working pressure: 16 bar

Spannbereich clamping range mm	Breite (b) width (b) mm	Art.-Nr.
20-29	61,5	330 22 13 16
28-34	71	330 22 19 16
32-40	81	330 22 25 16
39-49	92,5	330 22 32 16
48-60	105	330 22 38 16
60-76	115	330 22 50 16
77-94	150,5	330 22 63 16
94-115	163	330 22 75 16
115-145	198	330 22 89 16

Schlauchklemmen 2-teilig mit Sicherungsklauen DIN 20039 B

two part hose clamps with safety claws DIN 20039 B

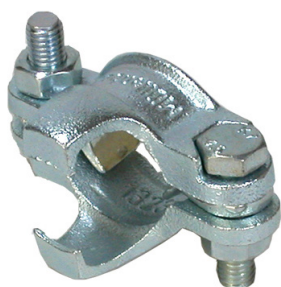

mit losen Zungen

Werkstoff: Temperguss, verzinkt

Betriebsdruck: 25 bar

with separate tongues

material: malleable iron, galvanized

working pressure: 25 bar

Spannbereich clamping range mm	Breite (b) width (b) mm	Art.-Nr.
20-29	63	330 23 13 25
28-33	70	330 23 19 25
35-42	84	330 23 25 25
40-47	92	330 23 28 25
48-60	106	330 23 35 25
53-68	117	330 23 42 25
58-76	117	330 23 50 25
75-88	154	330 23 65 25

Schlauchklemmen 3-teilig mit Sicherungsklauen DIN 20039 B

three part hose clamps with safety claws DIN 20039 B

mit losen Zungen

Werkstoff: Temperguss, verzinkt

Betriebsdruck: 25 bar

with separate tongues

material: malleable iron, galvanized

working pressure: 25 bar

Spannbereich clamping range mm	Breite (b) width (b) mm	Art.-Nr.
90-110	160	330 23 75 25
110-135	170	330 23 90 25
170-190	230	330 23 95 25

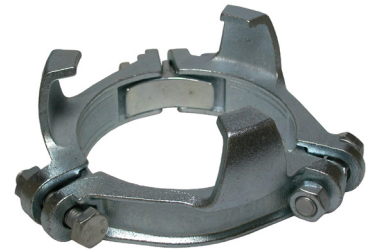

US-Schlauchklemmen 2-teilig mit Sicherungsklauen

two part US-hose clamps with safety claws

Spannbereich clamping range mm	Breite (b) width (b) mm	Art.-Nr.
21-27	54	330 24 13 00
30-35	63	330 24 19 00
36-45	83	330 24 25 00



Notizen/notes

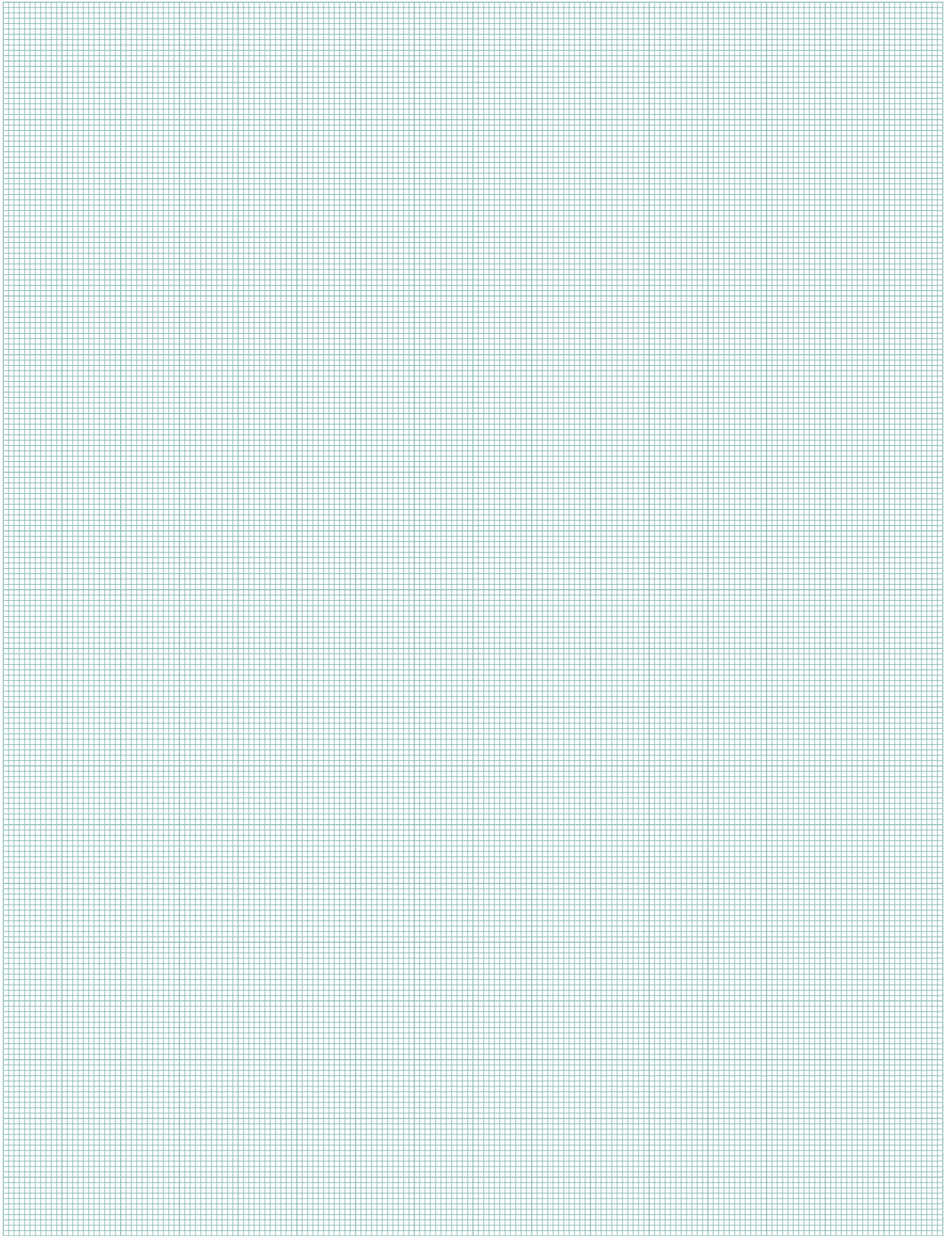

Mörtelkupplungen

Mortar couplings

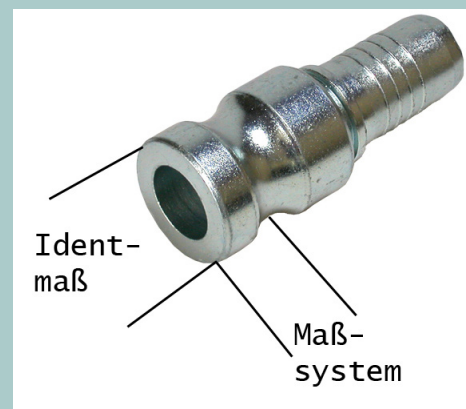
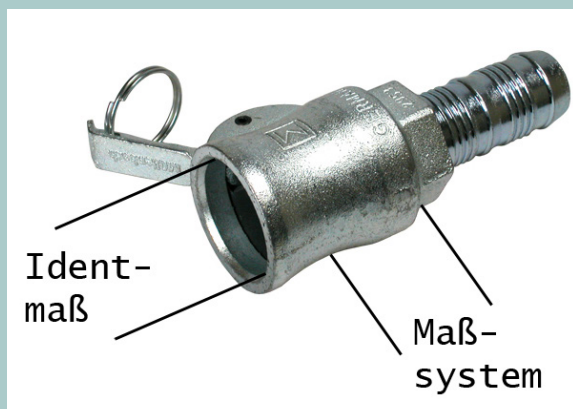

Muffen mit Schlauchtülle

female couplings with hose stem



mit einem Nockenhebel
Werkstoff: Kugelgraphitguss/Stahl, verzinkt
 with one handle
material: modular graphite cast iron/steel, galvanized

Einband clamp	Maßsystem measure	für Schlauch DN for hose NS	Identmaß ident-size mm	max. Betriebsdruck max. working pressure bar	Art.-Nr.
normal	22	25	35,5	50	332 01 32 11
normal	22	25	42	50	332 01 42 11
hydraul.	22	25	42	50	332 01 42 21

Muffen mit Schlauchtülle

female couplings with hose stem

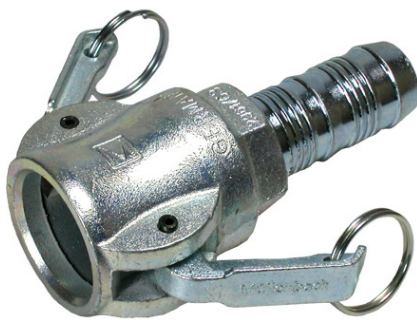

mit zwei Nockenhebeln
Werkstoff: Kugelgraphitguss/Stahl, verzinkt
 with two handles
material: modular graphite cast iron/steel, galvanized

Einband clamp	Maßsystem measure	für Schlauch DN for hose NS	Identmaß ident-size mm	max. Betriebsdruck max. working pressure bar	Art.-Nr.
normal	22	25	42	50	332 01 43 11
normal	22	35	51	50	332 01 53 11
normal	22	42	51	50	332 01 54 11
normal	22	42	64	50	332 01 64 11
normal	22	50	64	50	332 01 65 11
normal	23,5	35	51	50	332 01 53 12
normal	23,5	42	51	50	332 01 54 12
normal	23,5	42	64	50	332 01 64 12
normal	23,5	50	64	50	332 01 65 12
hydraul.	22	25	42	50	332 01 43 21
hydraul.	22	35	51	50	332 01 53 21
hydraul.	22	50	64	50	332 01 65 21
hydraul.	23,5	35	51	50	332 01 53 22
hydraul.	23,5	50	64	50	332 01 65 22

Muffen mit Außengewinde

female couplings with male thread



mit zwei Nockenhebeln
Werkstoff: Kugelgraphitguss/Stahl, verzinkt
 with two handles
material: modular graphite cast iron/steel, galvanized

Maßsystem measure	Außengewinde male thread	Identmaß ident-size mm	max. Betriebsdruck max. working pressure bar	Art.-Nr.
22	G 2 1/2"	64	50	332 02 66 01
23,5	G 2 1/2"	64	50	332 02 66 02

Muffen mit Innengewinde

female couplings with female thread

mit einem Nockenhebel

Werkstoff: Kugelgraphitguss/Stahl, verzinkt
with one handle

material: modular graphite cast iron/steel, galvanized

Maßsystem measure	Innengewinde female thread	Identmaß ident-size mm	max. Betriebsdruck max. working pressure bar	Art.-Nr.
22	R 1"	35,5	50	332 02 32 01
22	R 1"	42	50	332 02 42 01



Muffen mit Innengewinde

female couplings with female thread

mit zwei Nockenhebeln

Werkstoff: Kugelgraphitguss/Stahl, verzinkt
with two handles

material: modular graphite cast iron/steel, galvanized

Maßsystem measure	Innengewinde female thread	Identmaß ident-size mm	max. Betriebsdruck max. working pressure bar	Art.-Nr.
22	R 1"	42	50	332 02 42 11
22	R 1"	51	50	332 02 52 01
22	R 1 1/4"	51	50	332 02 53 01
22	R 1 1/2"	51	50	332 02 54 01
22	R 2"	64	50	332 02 65 01
23,5	R 1"	51	50	332 02 52 02
23,5	R 1 1/4"	51	50	332 02 53 02
23,5	R 1 1/2"	51	50	332 02 54 02
23,5	R 2"	64	50	332 02 65 02



Kunststoffmuffen mit Innengewinde

female couplings with male thread from plastics

mit zwei Nockenhebeln

Werkstoff: Kunststoff (PA 6)

Betriebsdruck: 25 bar
with two handles

material: plastics (PA 6)

working pressure: 25 bar

Maßsystem measure	Innengewinde female thread	Identmaß ident-size mm	Art.-Nr.
22	R 1"	42	332 02 43 11



Stecker mit Schlauchtülle

male couplings with hose stem



Werkstoff: Kugelgraphitguss/Stahl, verzinkt
material: modular graphite cast iron/steel, galvanized

Einband clamp	Maßsystem measure	für Schlauch DN for hose NS	Identmaß ident-size mm	max. Betriebsdruck max. working pressure bar	Art.-Nr.
normal	22	25	35	50	332 03 32 11
normal	22	25	41	50	332 03 42 11
normal	22	25	49,5	50	332 03 52 11
normal	22	35	49,5	50	332 03 53 11
normal	22	35	63	50	332 03 63 11
normal	22	42	49,5	50	332 03 54 11
normal	22	42	63	50	332 03 64 11
normal	22	50	63	50	332 03 65 11
normal	23,5	25	49,5	50	332 03 52 12
normal	23,5	35	49,5	50	332 03 53 12
normal	23,5	35	63	50	332 03 63 12
normal	23,5	42	49,5	50	332 03 54 12
normal	23,5	42	63	50	332 03 64 12
normal	23,5	50	63	50	332 03 65 12
hydraul.	22	25	41	50	332 03 42 21
hydraul.	22	25	49,5	50	332 03 52 21
hydraul.	22	35	49,5	50	332 03 53 21
hydraul.	22	35	63	50	332 03 63 21
hydraul.	22	50	63	50	332 03 65 21
hydraul.	23,5	25	49,5	50	332 03 52 22
hydraul.	23,5	35	49,5	50	332 03 53 22
hydraul.	23,5	35	63	50	332 03 63 22
hydraul.	23,5	50	63	50	332 03 65 22

Stecker mit Schlauchtülle - drehbar

male couplings with hose stem - rotatable

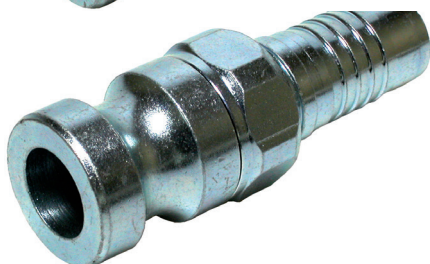

Werkstoff: Kugelgraphitguss/Stahl, verzinkt
material: modular graphite cast iron/steel, galvanized

Einband clamp	Maßsystem measure	für Schlauch DN for hose NS	Identmaß ident-size mm	max. Betriebsdruck max. working pressure bar	Art.-Nr.
normal	22	25	41	50	332 03 43 11
hydraul.	22	25	41	50	332 03 43 21

Stecker mit Innengewinde

male couplings with female thread

Werkstoff: Kugelgraphitguss/Stahl, verzinkt
material: modular graphite cast iron/steel, galvanized

Maßsystem measure	Innengewinde female thread	Identmaß ident-size mm	max. Betriebsdruck max. working pressure bar	Art.-Nr.
22	R 1"	35	50	332 04 32 01
22	R 1"	41	50	332 04 42 01
22	R 1 1/4"	41	50	332 04 43 01
22	R 1"	49,5	50	332 04 52 01
22	R 1 1/4"	49,5	50	332 04 53 01
22	R 1 1/2"	49,5	50	332 04 54 01
22	R 2"	63	50	332 04 65 01
22	R 2 1/2"	63	50	332 04 66 01
23,5	R 1"	49,5	50	332 04 52 02
23,5	R 1 1/4"	49,5	50	332 04 53 02
23,5	R 1 1/2"	49,5	50	332 04 54 02
23,5	R 2"	63	50	332 04 65 02
23,5	R 2 1/2"	63	50	332 04 66 02



Doppelstecker, reduziert

male adapter on both ends reduced

Werkstoff: Stahl, verzinkt
Betriebsdruck: 50 bar
material: steel, galvanized
working pressure: 50 bar

Größe 1 size 1	Maßsystem L1 measure L1	Identmaß 1 ident-size 1 mm	Größe 2 size 2	Maßsystem L2 measure L2	Identmaß 2 ident-size 2 mm	Art.-Nr.
25	22	41	25	22	35	332 05 41 31
35	22	49,5	25	22	35	332 05 51 31
35	23,5	49,5	25	22	35	332 05 52 31
35	22	49,5	25	22	41	332 05 51 41
35	23,5	49,5	25	22	41	332 05 52 41
50	22	63	25	22	41	332 05 61 41
50	23,5	63	25	22	41	332 05 62 41
50	22	63	35	22	49,5	332 05 61 51
50	23,5	63	35	23,5	49,5	332 05 62 52



Presshülsen für hydraulischen Einband

crimping sockets for hydraulic crimping

Größe size	für Schlauch for hose	Øi/ID	Øa/AD	Art.-Nr.
		mm	mm	
25	25X7	41	50	332 08 25 00
35	35X7	49	58	332 08 35 00
50	50X9	68,5	75	332 08 50 00



Einschraubtüllen

threaded stems



Werkstoff: Kugelgraphitguss/Stahl, verzinkt

Betriebsdruck: 50 bar

material: steel, galvanized

working pressure: 50 bar

Einband clamp	Außengewinde male thread	für Schlauch Innen-Ø/mm for hose internal-Ø/mm	Art.-Nr.
normal	G 1"	25	332 06 25 37
hydraul.	G 1"	25	332 06 26 37
normal	G 1 1/2"	35	332 06 35 39
normal	G 1 1/2"	42	332 06 42 39
normal	G 2"	50	332 06 42 40
normal	G 2"	42	332 06 50 40

Nockenhebel für alle Größen

handles for all sizes



Beschriftung labeling	Art.-Nr.
neutral	332 07 01 02

Spannstifte

pins



Größe size	Abmessungen measurements mm	Art.-Nr.
25, 35	6X30	332 07 02 01
50	6X40	332 07 02 02

Dichtungen

gaskets



Größe size	Abmessungen measurements mm	Identmaß ident-size mm	Art.-Nr.
25	36X24,5X6	35,5	332 08 36 00
25	42X28X6	42	332 08 42 00
35	53X38X6	51	332 08 53 00
50	60X50X6	64	332 08 60 00

Schalenverschraubungen

shell unions

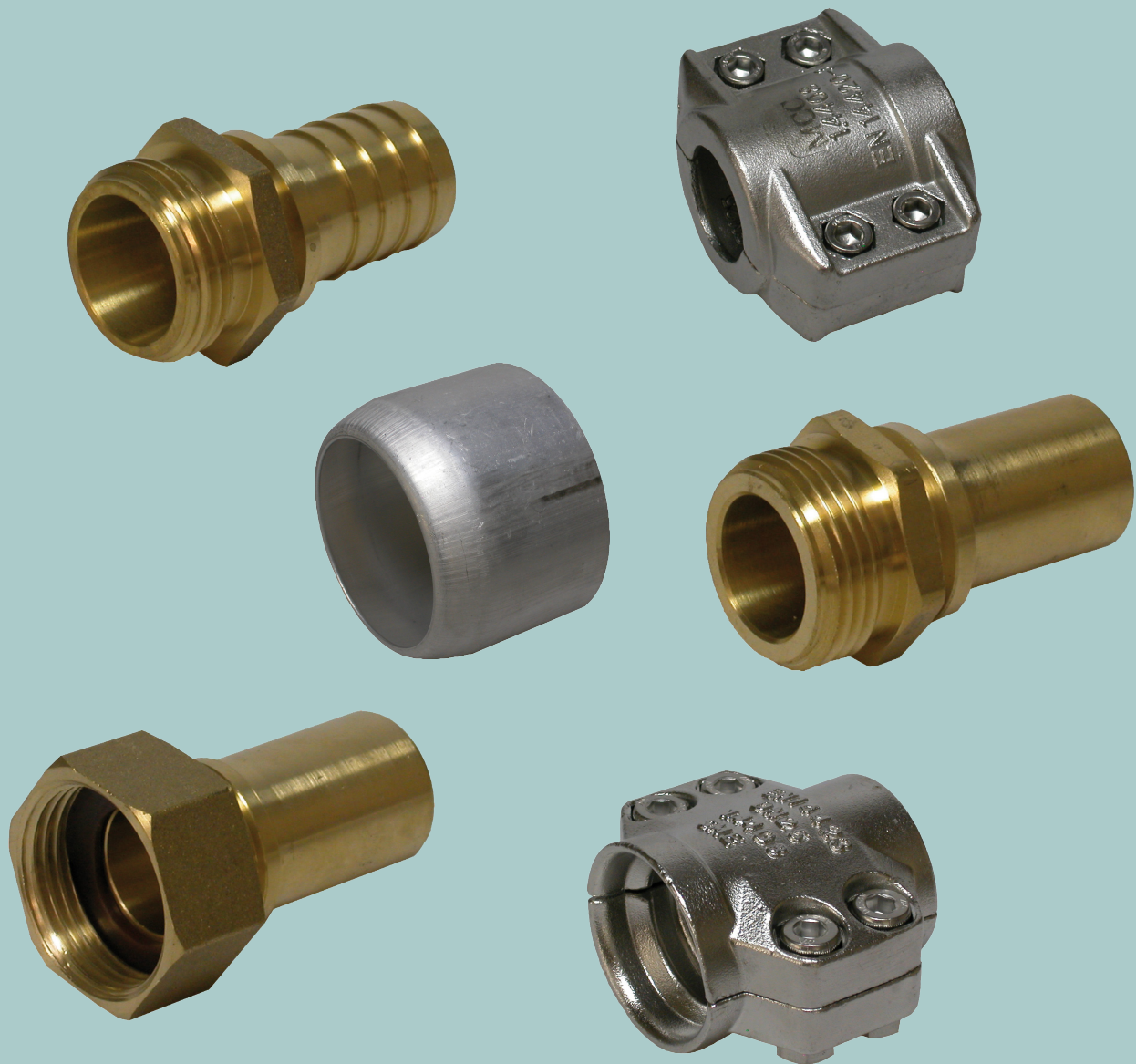

Schalenverschraubungen, glatt

shell unions, smooth



mit Außengewinde

with external thread

DN	Gewinde thread	Art.-Nr.
13	G 1/2"	333 33 13 34
20	G 3/4"	333 33 20 36
25	G 1"	333 33 25 37
32	G 1 1/4"	333 33 32 38
38	G 1 1/2"	333 33 38 39
50	G 2"	333 33 50 40
65	G 2 1/2"	333 33 65 41
80	G 3"	333 33 80 42
100	G 4"	333 33 90 43

Schalenverschraubungen, glatt

shell unions, smooth



mit Innengewinde

with internal thread

DN	Gewinde thread	Art.-Nr.
13	R 1/2"	333 34 13 34
20	R 3/4"	333 34 20 36
25	R 1"	333 34 25 37
32	R 1 1/4"	333 34 32 38
38	R 1 1/2"	333 34 38 39
50	R 2"	333 34 50 40
65	R 2 1/2"	333 34 65 41
80	R 3"	333 34 80 42
100	R 4"	333 34 90 43

Schalenverschraubungen

shell unions



mit Außengewinde

with external thread

DN	Gewinde thread	Art.-Nr.
13	G 1/2"	333 35 13 34
20	G 3/4"	333 35 20 36
25	G 1"	333 35 25 37
32	G 1 1/4"	333 35 32 38
38	G 1 1/2"	333 35 38 39
50	G 2"	333 35 50 40
65	G 2 1/2"	333 35 65 41
80	G 3"	333 35 80 42
100	G 4"	333 35 90 43

Schalenverschraubungen shell unions

mit Innengewinde with internal thread

DN	Gewinde thread	Art.-Nr.
13	R 1/2"	333 36 13 34
20	R 3/4"	333 36 20 36
25	R 1"	333 36 25 37
32	R 1 1/4"	333 36 32 38
38	R 1 1/2"	333 36 38 39
50	R 2"	333 36 50 40
65	R 2 1/2"	333 36 65 41
80	R 3"	333 36 80 42
100	R 4"	333 36 90 43

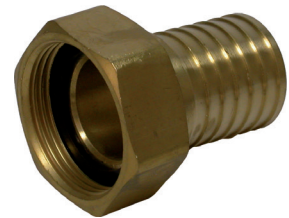

Klemmschalen shell clamps

für Schlauch DN for hose DN	Spannbereich clamping range mm	Art.-Nr.
13X5,0	22 - 24	330 26 13 05
19X6,0	30 - 33	330 26 19 06
25X5,0	40 - 42	330 26 25 05
25X6,0	36 - 39	330 26 25 06
25X8,0	40 - 43	330 26 25 08
32X5,0	47 - 49	330 26 32 05
32X6,0	43 - 46	330 26 32 06
32X8,0	47 - 50	330 26 32 08
38X5,0	47 - 49	330 26 38 05
38X6,5	50 - 53	330 26 38 06
38X8,0	53 - 56	330 26 38 08
38X10,0	57 - 60	330 26 38 10
40X7,0	53 - 56	330 26 40 07
40X10,0	58 - 61	330 26 40 10
45X7,0	58 - 61	330 26 45 07
50X6,0	61 - 63	330 26 50 06
50X8,0	63 - 67	330 26 50 08
50X10,0	69 - 71	330 26 50 10
63X6,0	74 - 76	330 26 63 06
63X10,0	84 - 87	330 26 63 10
65X7,0	78 - 82	330 26 65 07
75X8,0	89 - 93	330 26 75 08
75X10,0	94 - 97	330 26 75 10
80X8,0	94 - 97	330 26 80 08
90X6,5	104 - 108	330 26 90 06
100X8,0	114 - 119	330 26 93 08
100X10,0	118 - 122	330 26 93 10
125X10,0	143 - 148	330 26 95 10
150X10,0	178 - 184	330 26 97 10
200X12,0	222 - 229	330 26 99 12



Klemmschalen, Edelstahl

shell clamps, stainless steel



für Schlauch DN for hose DN	Spannbereich clamping range mm	Art.-Nr.
13X5,0	22 - 24	330 26 13 05v
19X6,0	30 - 33	330 26 19 06v
25X6,0	36 - 39	330 26 25 06v
32X6,0	43 - 46	330 26 32 06v
38X6,0	50 - 53	330 26 38 06v
50X6,0	61 - 65	330 26 50 06v
50X8,0	63 - 67	330 26 50 08v
50X10,0	69 - 71	330 26 50 10v
65X7,0	78 - 82	330 26 65 07v
75X8,0	89 - 93	330 26 75 08v
80X8,0	94 - 97	330 26 80 08v
100X8,0	114 - 118	330 26 93 08v

Klemmschalen für Dampfschlauch, Edelstahl

shell clamps for steam hose, stainless steel



für Schlauch DN for hose DN	Spannbereich clamping range mm	Art.-Nr.
13X6,0	24 - 26	330 27 13 06v
19X7,0	32 - 34	330 27 19 07v
25X7,5	39 - 41	330 27 25 07v
32X8,0	47 - 50	330 27 32 08v
38X8,0	53 - 56	330 27 35 08v
50X9,0	67 - 69	330 27 50 09v

Hülsen Edelstahl

hose sleeves, stainless steel



DN	Innen-Ø internal-Ø mm	Bodenloch-Ø soil hole-Ø mm	Gesamtlänge total length mm	Art.-Nr.
25	42,0	27,5	42,0	330 28 00 42v
32	50,0	36,0	45,0	330 28 00 50v
38	57,0	43,5	52,0	330 28 00 57v
50	67,0	55,0	63,0	330 28 00 67v
65	83,0	70,0	75,0	330 28 00 83v
70	84,0	70,0	76,0	330 28 00 84v
80	98,5	83,0	75,0	330 28 00 98v
100	122,5	107,0	87,0	330 28 01 22v

Hülsen für Rillenstutzen, Edelstahl

hose sleeves for grooves nozzle, stainless steel

DN	Innen-Ø internal-Ø mm	Bodenloch-Ø soil hole-Ø mm	Gesamtlänge total length mm	Art.-Nr.
25	42,0	27,5	42,0	330 29 00 42v
32	50,0	36,0	45,0	330 29 00 50v
38	57,0	45,5	52,0	330 29 00 57v
50	67,0	55,0	63,0	330 29 00 67v
65	83,0	68,0	73,0	330 29 00 83v
80	98,5	83,3	75,0	330 29 00 98v
100	123,0	107,0	87,0	330 29 01 23v



Hülsen, Aluminium

hose sleeves, aluminium

DN	Innen-Ø internal-Ø mm	Bodenloch-Ø soil hole-Ø mm	Gesamtlänge total length mm	Art.-Nr.
25	41,0	27,0	44,0	330 30 00 41
32	50,0	36,0	45,0	330 30 00 50
38	56,0	43,5	52,0	330 30 00 56
50	67,0	55,0	63,0	330 30 00 67
50	70,0	55,0	63,0	330 30 00 70
50	60,0	52,0	45,0	330 30 00 60
65	84,0	68,0	73,0	330 30 00 84
65	85,0	71,0	55,0	330 30 00 85
65	89,0	71,0	55,0	330 30 00 89
75	88,0	76,0	75,0	330 30 00 88
80	98,4	83,5	75,0	330 30 10 98
80	102,0	87,0	75,0	330 30 11 02
80	96,0	91,0	74,0	330 30 10 96
80	105,0	91,0	74,0	330 30 11 05
80	102,0	91,0	74,0	330 30 11 03
100	122,5	107,0	87,0	330 30 21 22
100	126,0	107,0	87,0	330 30 21 26
100	130,0	111,0	87,0	330 30 31 30
100	124,0	111,0	87,0	330 30 31 24



Fassungen, Edelstahl

ferrules, stainless steel



DN	für Schlauch Außen-Ø max. for hose external-Ø max. mm	Art.-Nr.
13	25	330 31 00 25v
16	28	330 31 00 28v
19	32	330 31 00 32v
25	39	330 31 00 39v
32	46	330 31 00 46v
38	52	330 31 00 52v
50	67	330 31 00 67v
65	82	330 31 00 82v
70	86	330 31 00 86v
80	93	330 31 00 93v
100	122	330 31 01 22v
125	152	330 31 01 52v
150	182	330 31 01 82v

Fassungen, Stahl

ferrules, steel



DN	für Schlauch Außen-Ø max. for hose external-Ø max. mm	Art.-Nr.
13	25	330 31 00 25
16	28	330 31 00 28
19	32	330 31 00 32
25	39	330 31 00 39
32	46	330 31 00 46
38	52	330 31 00 52
50	67	330 31 00 67
65	82	330 31 00 82
80	93	330 31 00 93
100	122	330 31 01 22
150	182	330 31 01 82

Fassungen, Aluminium

ferrules, aluminium



Innen-Ø internal-Ø mm	Stärke thickness mm	Gesamtlänge total length mm	Art.-Nr.
26,0	2,0	30,0	330 32 00 26
31,0	2,0	30,0	330 32 00 31
36,0	2,0	30,0	330 32 00 36
46,0	2,0	30,0	330 32 00 46
51,0	2,0	30,0	330 32 00 51
57,0	2,0	30,0	330 32 00 57
67,0	2,0	30,0	330 32 00 67
76,0	2,0	40,0	330 32 00 76
80,0	2,0	40,0	330 32 00 80
84,0	2,0	40,0	330 32 00 84
101,0	2,0	65,0	330 32 01 01
102,0	2,5	90,0	330 32 01 02
120,0	2,5	90,0	330 32 01 20

Hülsen, Edelstahl

sleeves, stainless steel



Innen-Ø internal-Ø mm	Stärke thickness mm	Gesamtlänge total length mm	Art.-Nr.
13,0	1,5	20,0	330 32 00 13v
14,5	1,5	20,0	330 32 00 14v
16,5	1,5	20,0	330 32 00 16v
20,5	1,5	20,0	330 32 00 20v
29,5	1,5	25,0	330 32 00 29v
37,0	2,0	25,0	330 32 00 37v
44,5	2,0	30,0	330 32 00 44v
54,5	2,0	30,0	330 32 00 54v
68,0	2,0	35,0	330 32 00 68v
84,5	2,0	35,0	330 32 00 84v
98,5	2,0	40,0	330 32 00 98v
121,0	2,0	50,0	330 32 01 21v



Notizen/notes

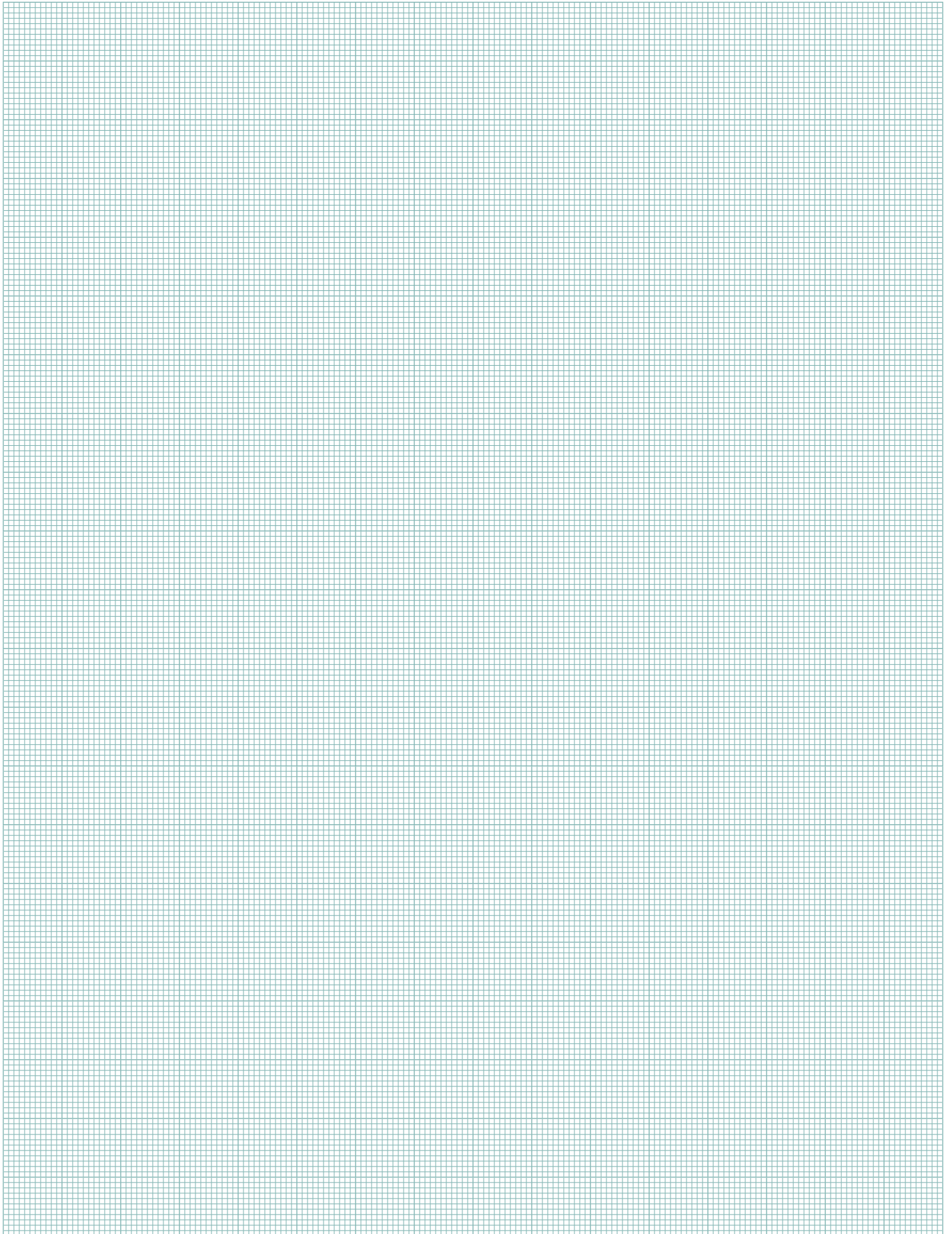

Tankwagen-Kupplungen

tanker couplings

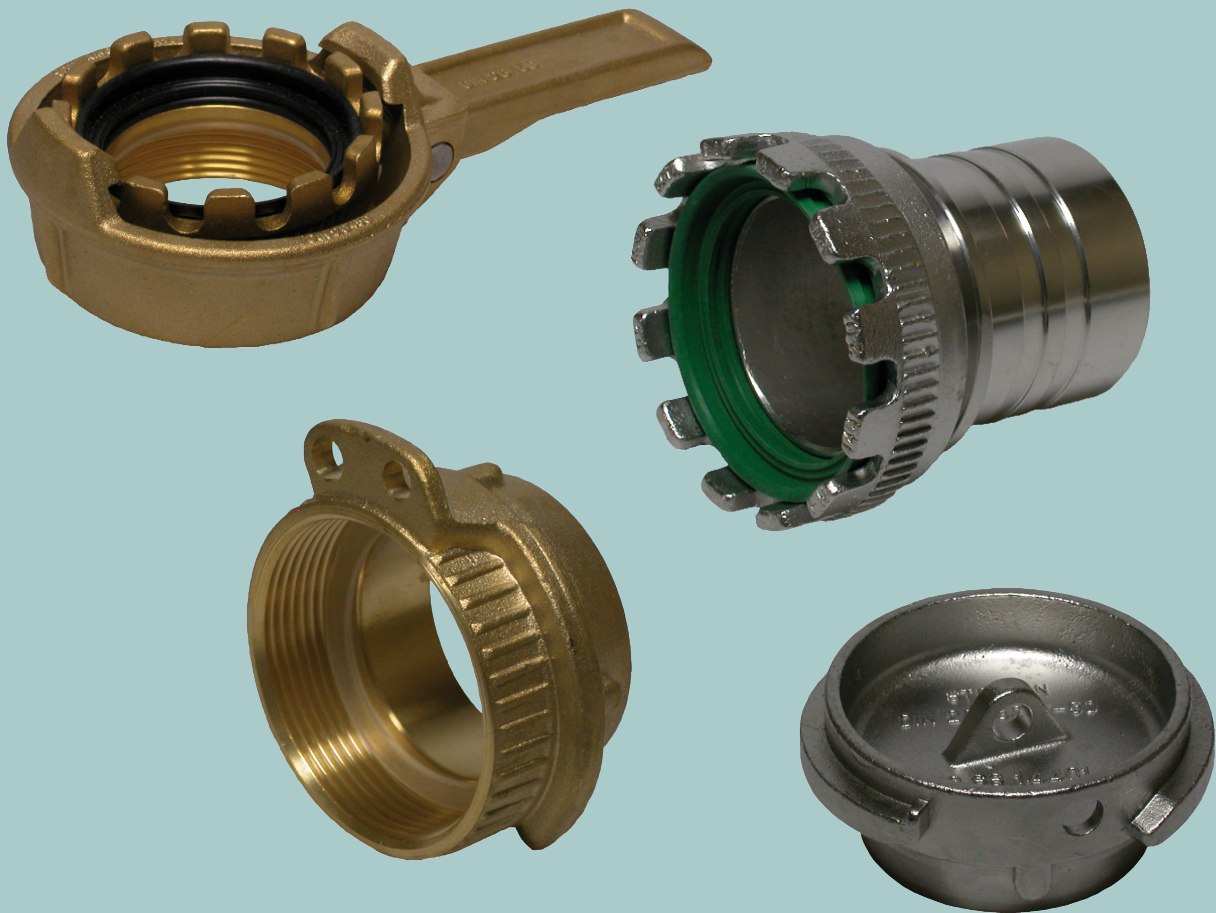

Kupplungs-Spannringe

coupling clamping rings



DN	Gewinde thread	Art.-Nr.
50	G 2"	330 50 00 50
80	G 3"	330 50 00 80
100	G 4"	330 50 01 00

Kupplungs-Stecker

male couplings



DN	Gewinde thread	Art.-Nr.
50	G 2"	330 51 00 50
80	G 3"	330 51 00 80
100	G 4"	330 51 01 00

Kupplungs-Spannringe, Edelstahl

coupling clamping rings, stainless steel



DN	Gewinde thread	Art.-Nr.
50	G 2"	330 50 00 50v
80	G 3"	330 50 00 80v
100	G 4"	330 50 01 00v

Kupplungs-Stecker, Edelstahl

male couplings, stainless steel



DN	Gewinde thread	Art.-Nr.
50	G 2"	330 51 00 50v
80	G 3"	330 51 00 80v
100	G 4"	330 51 01 00v

Kupplungs-Muffe, Edelstahl

female couplings, stainless steel

DN	für Schlauch DN for hose DN	Art.-Nr.
50	50	330 53 00 50v
80	75	330 53 00 80v



Kupplungs-Stecker, Edelstahl

male couplings, stainless steel

DN	für Schlauch DN for hose DN	Art.-Nr.
50	50	330 54 00 50v
80	75	330 54 00 80v



Kappen

caps

DN	Art.-Nr.
50	330 52 00 50
80	330 52 00 80
00	330 52 01 00



Kappen, Edelstahl

caps, stainless steel

DN	Art.-Nr.
50	330 52 00 50v
80	330 52 00 80v
100	330 52 01 00v



Stopfen plugs



DN	Art.-Nr.
50	330 55 00 50
80	330 55 00 80
100	330 55 01 00

Stopfen, Edelstahl plugs, stainless steel



DN	Art.-Nr.
50	330 55 00 50v
80	330 55 00 80v

Dichtungen seals



DN	Material material	Art.-Nr.
50	CSM	330 56 10 50
80	CSM	330 56 10 80
100	CSM	330 56 11 00
50	NBR	330 56 20 50
80	NBR	330 56 20 80
100	NBR	330 56 21 00
50	FKM	330 56 30 50
80	FKM	330 56 30 80
100	FKM	330 56 31 00
50	Teflon	330 56 40 50
80	Teflon	330 56 40 80
100	Teflon	330 56 41 00

API Mutter, Aluminium

API female, aluminium

DN	Gewinde thread	Art.-Nr.
80	R 3"	330 57 00 80
100	R 3"	330 57 01 00



API Guillemín, verriegelbar

API Guillemín, lockable

DN	Gewinde thread	Art.-Nr.
80	G 3"	330 58 03 80
80	G 4"	330 58 04 80



API Guillemín Adapter

API Guillemín adapter

DN	Gewinde thread	Art.-Nr.
80	G 3"	330 58 03 81
80	G 4"	330 58 04 81



Notizen/notes

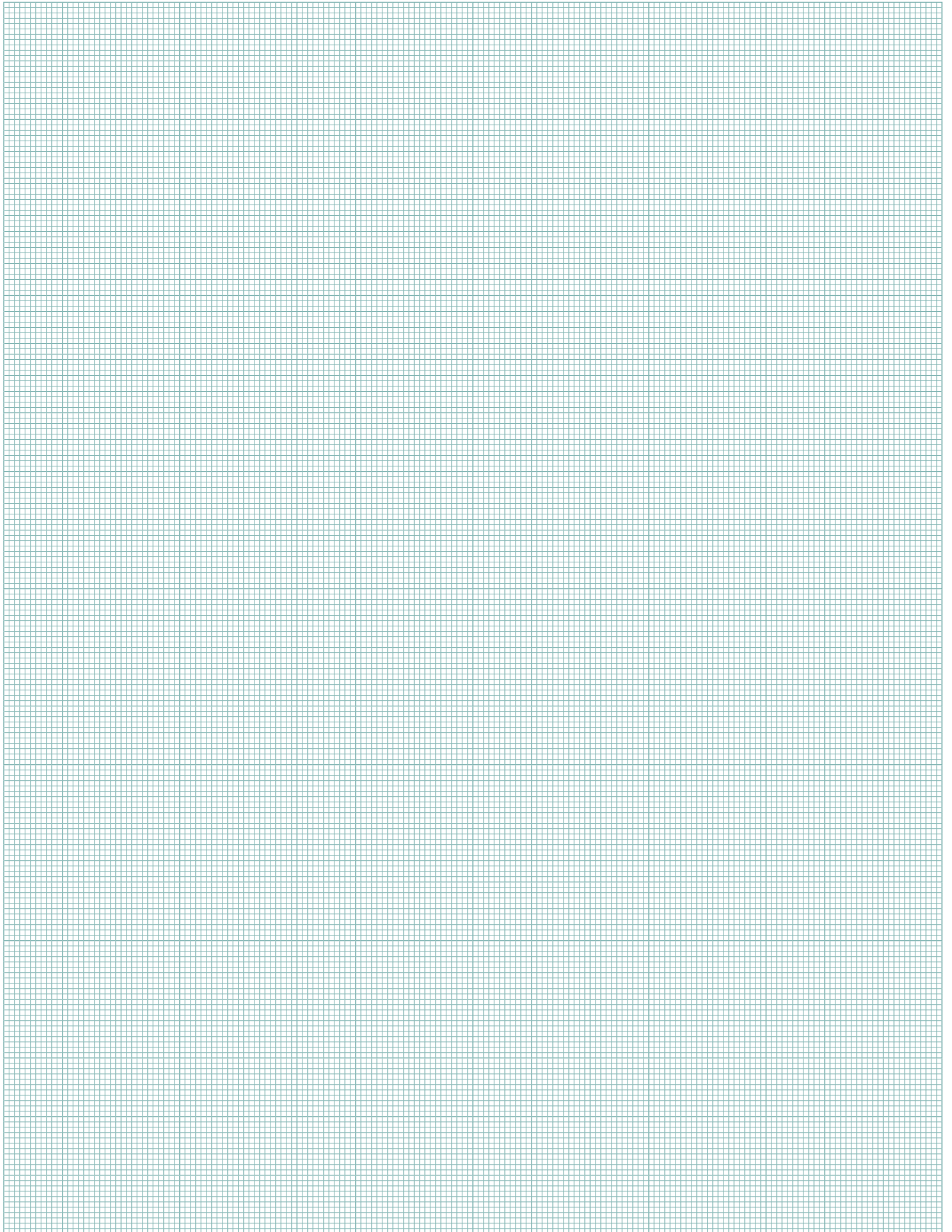

Kamlok-Kupplungen

Kamlok couplings



Kamlok Varterteile Typ A

Kamlok males type A



mit zölligem Innengewinde with inch internal thread

DN	Gewinde thread	Material material	Art.-Nr.
15	R 1/2"	Edelstahl	330 60 10 15
20	R 3/4"	Edelstahl	330 60 10 20
25	R 1"	Edelstahl	330 60 10 25
32	R 1 1/4"	Edelstahl	330 60 10 32
40	R 1 1/2"	Edelstahl	330 60 10 40
50	R 2"	Edelstahl	330 60 10 50
65	R 2 1/2"	Edelstahl	330 60 10 65
80	R 3"	Edelstahl	330 60 10 80
100	R 4"	Edelstahl	330 60 11 00
125	R 5"	Edelstahl	330 60 11 25
150	R 6"	Edelstahl	330 60 11 50
15	R 1/2"	Aluminium	330 60 20 15
20	R 3/4"	Aluminium	330 60 20 20
25	R 1"	Aluminium	330 60 20 25
32	R 1 1/4"	Aluminium	330 60 20 32
40	R 1 1/2"	Aluminium	330 60 20 40
50	R 2"	Aluminium	330 60 20 50
65	R 2 1/2"	Aluminium	330 60 20 65
80	R 3"	Aluminium	330 60 20 80
100	R 4"	Aluminium	330 60 21 00
125	R 5"	Aluminium	330 60 21 25
150	R 6"	Aluminium	330 60 21 50
200	R 8"	Aluminium	330 60 22 00
15	R 1/2"	Messing	330 60 30 15
20	R 3/4"	Messing	330 60 30 20
25	R 1"	Messing	330 60 30 25
32	R 1 1/4"	Messing	330 60 30 32
40	R 1 1/2"	Messing	330 60 30 40
50	R 2"	Messing	330 60 30 50
65	R 2 1/2"	Messing	330 60 30 65
80	R 3"	Messing	330 60 30 80
100	R 4"	Messing	330 60 31 00
125	R 5"	Messing	330 60 31 25
150	R 6"	Messing	330 60 31 50
15	R 1/2"	Polypropylen	330 60 40 15
20	R 3/4"	Polypropylen	330 60 40 20
25	R 1"	Polypropylen	330 60 40 25
32	R 1 1/4"	Polypropylen	330 60 40 32
40	R 1 1/4"	Polypropylen	330 60 40 39
40	R 1 1/2"	Polypropylen	330 60 40 40
50	R 2"	Polypropylen	330 60 40 50
80	R 3"	Polypropylen	330 60 40 80
100	R 4"	Polypropylen	330 60 41 00

Kamlok Mutterteile Typ B

Kamlok females type B

mit zölligem Außengewinde
with inch external thread

DN	Gewinde thread	Material material	Art.-Nr.
15	G 1/2"	Edelstahl	330 61 10 15
20	G 3/4"	Edelstahl	330 61 10 20
25	G 1"	Edelstahl	330 61 10 25
32	G 1 1/4"	Edelstahl	330 61 10 32
40	G 1 1/2"	Edelstahl	330 61 10 40
50	G 2"	Edelstahl	330 61 10 50
65	G 2 1/2"	Edelstahl	330 61 10 65
80	G 3"	Edelstahl	330 61 10 80
100	G 4"	Edelstahl	330 61 11 00
125	G 5"	Edelstahl	330 61 11 25
150	G 6"	Edelstahl	330 61 11 50
15	G 1/2"	Aluminium	330 61 20 15
20	G 3/4"	Aluminium	330 61 20 20
25	G 1"	Aluminium	330 61 20 25
32	G 1 1/4"	Aluminium	330 61 20 32
40	G 1 1/2"	Aluminium	330 61 20 40
50	G 2"	Aluminium	330 61 20 50
65	G 2 1/2"	Aluminium	330 61 20 65
80	G 3"	Aluminium	330 61 20 80
100	G 4"	Aluminium	330 61 21 00
125	G 5"	Aluminium	330 61 21 25
150	G 6"	Aluminium	330 61 21 50
200	G 8"	Aluminium	330 61 22 00
15	G 1/2"	Messing	330 61 30 15
20	G 3/4"	Messing	330 61 30 20
25	G 1"	Messing	330 61 30 25
32	G 1 1/4"	Messing	330 61 30 32
40	G 1 1/2"	Messing	330 61 30 40
50	G 2"	Messing	330 61 30 50
65	G 2 1/2"	Messing	330 61 30 65
80	G 3"	Messing	330 61 30 80
100	G 4"	Messing	330 61 31 00
125	G 5"	Messing	330 61 31 25
150	G 6"	Messing	330 61 31 50
15	G 1/2"	Polypropylen	330 61 40 15
20	G 3/4"	Polypropylen	330 61 40 20
25	G 1"	Polypropylen	330 61 40 25
32	G 1 1/4"	Polypropylen	330 61 40 32
40	G 1 1/4"	Polypropylen	330 61 40 39
40	G 1 1/2"	Polypropylen	330 61 40 40
50	G 2"	Polypropylen	330 61 40 50
80	G 3"	Polypropylen	330 61 40 80
100	G 4"	Polypropylen	330 61 41 00



Kamlok Mutterteile Typ C

Kamlok females type C

mit Schlauchstutzen with hose connector



DN	Stutzen-Ø connector-Ø mm	Material material	Art.-Nr.
15	16	Edelstahl	330 62 10 15
20	21	Edelstahl	330 62 10 20
25	27	Edelstahl	330 62 10 25
32	34	Edelstahl	330 62 10 32
40	40	Edelstahl	330 62 10 40
50	51	Edelstahl	330 62 10 50
65	64	Edelstahl	330 62 10 65
80	76	Edelstahl	330 62 10 80
100	103	Edelstahl	330 62 11 00
125	128	Edelstahl	330 62 11 25
150	152	Edelstahl	330 62 11 50
15	16	Aluminium	330 62 20 15
20	21	Aluminium	330 62 20 20
25	27	Aluminium	330 62 20 25
32	34	Aluminium	330 62 20 32
40	40	Aluminium	330 62 20 40
50	51	Aluminium	330 62 20 50
65	64	Aluminium	330 62 20 65
80	76	Aluminium	330 62 20 80
100	103	Aluminium	330 62 21 00
125	128	Aluminium	330 62 21 25
150	152	Aluminium	330 62 21 50
200	200	Aluminium	330 62 22 00
15	16	Messing	330 62 30 15
20	21	Messing	330 62 30 20
25	27	Messing	330 62 30 25
32	34	Messing	330 62 30 32
40	40	Messing	330 62 30 40
50	51	Messing	330 62 30 50
65	64	Messing	330 62 30 65
80	76	Messing	330 62 30 80
100	103	Messing	330 62 31 00
125	128	Messing	330 62 31 25
150	152	Messing	330 62 31 50
15	16	Polypropylen	330 62 40 15
20	21	Polypropylen	330 62 40 20
25	27	Polypropylen	330 62 40 25
32	34	Polypropylen	330 62 40 32
40	32	Polypropylen	330 62 40 39
40	40	Polypropylen	330 62 40 40
50	51	Polypropylen	330 62 40 50
80	76	Polypropylen	330 62 40 80
100	103	Polypropylen	330 62 41 00

Kamlok Mutterteile Typ D

Kamlok females type D

mit zölligem Innengewinde
with inch internal thread

DN	Gewinde thread	Material material	Art.-Nr.
15	R 1/2"	Edelstahl	330 63 10 15
20	R 3/4"	Edelstahl	330 63 10 20
25	R 1"	Edelstahl	330 63 10 25
32	R 1 1/4"	Edelstahl	330 63 10 32
40	R 1 1/2"	Edelstahl	330 63 10 40
50	R 2"	Edelstahl	330 63 10 50
65	R 2 1/2"	Edelstahl	330 63 10 65
80	R 3"	Edelstahl	330 63 10 80
100	R 4"	Edelstahl	330 63 11 00
125	R 5"	Edelstahl	330 63 11 25
150	R 6"	Edelstahl	330 63 11 50
15	R 1/2"	Aluminium	330 63 20 15
20	R 3/4"	Aluminium	330 63 20 20
25	R 1"	Aluminium	330 63 20 25
32	R 1 1/4"	Aluminium	330 63 20 32
40	R 1 1/2"	Aluminium	330 63 20 40
50	R 2"	Aluminium	330 63 20 50
65	R 2 1/2"	Aluminium	330 63 20 65
80	R 3"	Aluminium	330 63 20 80
100	R 4"	Aluminium	330 63 21 00
125	R 5"	Aluminium	330 63 21 25
150	R 6"	Aluminium	330 63 21 50
200	R 8"	Aluminium	330 63 22 00
15	R 1/2"	Messing	330 63 30 15
20	R 3/4"	Messing	330 63 30 20
25	R 1"	Messing	330 63 30 25
32	R 1 1/4"	Messing	330 63 30 32
40	R 1 1/2"	Messing	330 63 30 40
50	R 2"	Messing	330 63 30 50
65	R 2 1/2"	Messing	330 63 30 65
80	R 3"	Messing	330 63 30 80
100	R 4"	Messing	330 63 31 00
125	R 5"	Messing	330 63 31 25
150	R 6"	Messing	330 63 31 50
15	R 1/2"	Polypropylen	330 63 40 15
20	R 3/4"	Polypropylen	330 63 40 20
25	R 1"	Polypropylen	330 63 40 25
32	R 1 1/4"	Polypropylen	330 63 40 32
40	R 1 1/4"	Polypropylen	330 63 40 39
40	R 1 1/2"	Polypropylen	330 63 40 40
50	R 2"	Polypropylen	330 63 40 50
80	R 3"	Polypropylen	330 63 40 80
100	R 4"	Polypropylen	330 63 41 00



Kamlok Varterteile Typ E

Kamlok males type E



mit Schlauchstutzen with hose connector

DN	Stutzen connector mm	Material material	Art.-Nr.
15	16	Edelstahl	330 64 10 15
20	21	Edelstahl	330 64 10 20
25	27	Edelstahl	330 64 10 25
32	34	Edelstahl	330 64 10 32
40	40	Edelstahl	330 64 10 40
50	51	Edelstahl	330 64 10 50
65	64	Edelstahl	330 64 10 65
80	76	Edelstahl	330 64 10 80
100	103	Edelstahl	330 64 11 00
125	128	Edelstahl	330 64 11 25
150	152	Edelstahl	330 64 11 50
15	16	Aluminium	330 64 20 15
20	21	Aluminium	330 64 20 20
25	27	Aluminium	330 64 20 25
32	34	Aluminium	330 64 20 32
40	40	Aluminium	330 64 20 40
50	51	Aluminium	330 64 20 50
65	64	Aluminium	330 64 20 65
80	76	Aluminium	330 64 20 80
100	103	Aluminium	330 64 21 00
125	128	Aluminium	330 64 21 25
150	152	Aluminium	330 64 21 50
200	200	Aluminium	330 64 22 00
15	16	Messing	330 64 30 15
20	21	Messing	330 64 30 20
25	27	Messing	330 64 30 25
32	34	Messing	330 64 30 32
40	40	Messing	330 64 30 40
50	51	Messing	330 64 30 50
65	64	Messing	330 64 30 65
80	76	Messing	330 64 30 80
100	103	Messing	330 64 31 00
125	128	Messing	330 64 31 25
150	152	Messing	330 64 31 50
15	16	Polypropylen	330 64 40 15
20	21	Polypropylen	330 64 40 20
25	27	Polypropylen	330 64 40 25
32	34	Polypropylen	330 64 40 32
40	32	Polypropylen	330 64 40 39
40	40	Polypropylen	330 64 40 40
50	51	Polypropylen	330 64 40 50
80	76	Polypropylen	330 64 40 80
100	103	Polypropylen	330 64 41 00

Kamlok Varterteile Typ F

Kamlok males type F

mit zölligem Außengewinde
with inch external thread

DN	Gewinde thread	Material material	Art.-Nr.
15	G 1/2"	Edelstahl	330 65 10 15
20	G 3/4"	Edelstahl	330 65 10 20
25	G 1"	Edelstahl	330 65 10 25
32	G 1 1/4"	Edelstahl	330 65 10 32
40	G 1 1/2"	Edelstahl	330 65 10 40
50	G 2"	Edelstahl	330 65 10 50
65	G 2 1/2"	Edelstahl	330 65 10 65
80	G 3"	Edelstahl	330 65 10 80
100	G 4"	Edelstahl	330 65 11 00
125	G 5"	Edelstahl	330 65 11 25
150	G 6"	Edelstahl	330 65 11 50
15	G 1/2"	Aluminium	330 65 20 15
20	G 3/4"	Aluminium	330 65 20 20
25	G 1"	Aluminium	330 65 20 25
32	G 1 1/4"	Aluminium	330 65 20 32
40	G 1 1/2"	Aluminium	330 65 20 40
50	G 2"	Aluminium	330 65 20 50
65	G 2 1/2"	Aluminium	330 65 20 65
80	G 3"	Aluminium	330 65 20 80
100	G 4"	Aluminium	330 65 21 00
125	G 5"	Aluminium	330 65 21 25
150	G 6"	Aluminium	330 65 21 50
200	G 8"	Aluminium	330 65 22 00
15	G 1/2"	Messing	330 65 30 15
20	G 3/4"	Messing	330 65 30 20
25	G 1"	Messing	330 65 30 25
32	G 1 1/4"	Messing	330 65 30 32
40	G 1 1/2"	Messing	330 65 30 40
50	G 2"	Messing	330 65 30 50
65	G 2 1/2"	Messing	330 65 30 65
80	G 3"	Messing	330 65 30 80
100	G 4"	Messing	330 65 31 00
125	G 5"	Messing	330 65 31 25
150	G 6"	Messing	330 65 31 50
15	G 1/2"	Polypropylen	330 65 40 15
20	G 3/4"	Polypropylen	330 65 40 20
25	G 1"	Polypropylen	330 65 40 25
32	G 1 1/4"	Polypropylen	330 65 40 32
40	G 1 1/4"	Polypropylen	330 65 40 39
40	G 1 1/2"	Polypropylen	330 65 40 40
50	G 2"	Polypropylen	330 65 40 50
80	G 3"	Polypropylen	330 65 40 80
100	G 4"	Polypropylen	330 65 41 00



Kamlok Kappen Typ DC

Kamlok caps type DC



DN	Material material	Art.-Nr.
15	Edelstahl	330 66 10 15
20	Edelstahl	330 66 10 20
25	Edelstahl	330 66 10 25
32	Edelstahl	330 66 10 32
40	Edelstahl	330 66 10 40
50	Edelstahl	330 66 10 50
65	Edelstahl	330 66 10 65
80	Edelstahl	330 66 10 80
100	Edelstahl	330 66 11 00
125	Edelstahl	330 66 11 25
150	Edelstahl	330 66 11 50
15	Aluminium	330 66 20 15
20	Aluminium	330 66 20 20
25	Aluminium	330 66 20 25
32	Aluminium	330 66 20 32
40	Aluminium	330 66 20 40
50	Aluminium	330 66 20 50
65	Aluminium	330 66 20 65
80	Aluminium	330 66 20 80
100	Aluminium	330 66 21 00
125	Aluminium	330 66 21 25
150	Aluminium	330 66 21 50
200	Aluminium	330 66 22 00
15	Messing	330 66 30 15
20	Messing	330 66 30 20
25	Messing	330 66 30 25
32	Messing	330 66 30 32
40	Messing	330 66 30 40
50	Messing	330 66 30 50
65	Messing	330 66 30 65
80	Messing	330 66 30 80
100	Messing	330 66 31 00
125	Messing	330 66 31 25
150	Messing	330 66 31 50
15	Polypropylen	330 66 40 15
20	Polypropylen	330 66 40 20
25	Polypropylen	330 66 40 25
32	Polypropylen	330 66 40 32
40	Polypropylen	330 66 40 40
50	Polypropylen	330 66 40 50
80	Polypropylen	330 66 40 80
100	Polypropylen	330 66 41 00

Kamlok Stopfen Typ DP

Kamlok plugs type DP

DN	Material material	Art.-Nr.
15	Edelstahl	330 67 10 15
20	Edelstahl	330 67 10 20
25	Edelstahl	330 67 10 25
32	Edelstahl	330 67 10 32
40	Edelstahl	330 67 10 40
50	Edelstahl	300 67 10 50
65	Edelstahl	330 67 10 65
80	Edelstahl	330 67 10 80
100	Edelstahl	330 67 11 00
125	Edelstahl	330 67 11 25
150	Edelstahl	330 67 11 50
15	Aluminium	330 67 20 15
20	Aluminium	330 67 20 20
25	Aluminium	330 67 20 25
32	Aluminium	330 67 20 32
40	Aluminium	330 67 20 40
50	Aluminium	330 67 20 50
65	Aluminium	330 67 20 65
80	Aluminium	330 67 20 80
100	Aluminium	330 67 21 00
125	Aluminium	330 67 21 25
150	Aluminium	330 67 21 50
200	Aluminium	330 67 22 00
15	Messing	330 67 30 15
20	Messing	330 67 30 20
25	Messing	330 67 30 25
32	Messing	330 67 30 32
40	Messing	330 67 30 40
50	Messing	330 67 30 50
65	Messing	330 67 30 65
80	Messing	330 67 30 80
100	Messing	330 67 31 00
125	Messing	330 67 31 25
150	Messing	330 67 31 50
15	Polypropylen	330 67 40 15
20	Polypropylen	330 67 40 20
25	Polypropylen	330 67 40 25
32	Polypropylen	330 67 40 32
40	Polypropylen	330 67 40 40
50	Polypropylen	330 67 40 50
80	Polypropylen	330 67 40 80
100	Polypropylen	330 67 41 00



Kamlok Varterteile Typ A

Kamlok males type A



**EN 14420 - vormals DIN 2828
mit zölligem Innengewinde**
**EN 14420 - formerly DIN 2828
with inch internal thread**

DN	Gewinde thread	Material material	Art.-Nr.
20	R 3/4"	Edelstahl	330 68 10 20
25	R 1"	Edelstahl	330 68 10 25
32	R 1 1/4"	Edelstahl	330 68 10 32
40	R 1 1/2"	Edelstahl	330 68 10 40
50	R 2"	Edelstahl	330 68 10 50
65	R 2 1/2"	Edelstahl	330 68 10 65
80	R 3"	Edelstahl	330 68 10 80
100	R 4"	Edelstahl	330 68 11 00

Kamlok Mutterteile Typ D

Kamlok females type D



**EN 14420 - vormals DIN 2828
mit zölligem Innengewinde**
**EN 14420 - formerly DIN 2828
with inch internal thread**

DN	Gewinde thread	Material material	Art.-Nr.
20	R 3/4"	Edelstahl	330 69 10 20
25	R 1"	Edelstahl	330 69 10 25
32	R 1 1/4"	Edelstahl	330 69 10 32
40	R 1 1/2"	Edelstahl	330 69 10 40
50	R 2"	Edelstahl	330 69 10 50
65	R 2 1/2"	Edelstahl	330 69 10 65
80	R 3"	Edelstahl	330 69 10 80
100	R 4"	Edelstahl	330 69 11 00

Kamlok Mutterteile Typ C

Kamlok females type C

EN 14420 - vormalig DIN 2828
mit Schlauchstutzen
EN 14420 - formerly DIN 2828
with hose connector

DN	Stutzen-Ø connector-Ø mm	Material material	Art.-Nr.
20	19	Edelstahl	330 70 10 20
25	25	Edelstahl	330 70 10 25
32	32	Edelstahl	330 70 10 32
40	38	Edelstahl	330 70 10 40
50	50	Edelstahl	330 70 10 50
65	64	Edelstahl	330 70 10 65
80	75	Edelstahl	330 70 10 80
100	100	Edelstahl	330 70 11 00
40	38	Messing	330 70 20 40
50	50	Messing	330 70 20 50
80	75	Messing	330 70 20 80
100	100	Messing	330 70 21 00



Kamlok Vaterteile Typ E

Kamlok males type E

EN 14420 - vormalig DIN 2828
mit Schlauchstutzen
EN 14420 - formerly DIN 2828
with hose connector

DN	Stutzen-Ø connector-Ø mm	Material material	Art.-Nr.
20	19	Edelstahl	330 71 10 20
25	25	Edelstahl	330 71 10 25
32	32	Edelstahl	330 71 10 32
40	38	Edelstahl	330 71 10 40
50	50	Edelstahl	330 71 10 50
65	64	Edelstahl	330 71 10 65
80	75	Edelstahl	330 71 10 80
100	100	Edelstahl	330 71 11 00
20	19	Messing	330 71 30 20
25	25	Messing	330 71 30 25
32	32	Messing	330 71 30 32
40	38	Messing	330 71 30 40
50	50	Messing	330 71 30 50
80	75	Messing	330 71 30 80
100	100	Messing	330 71 31 00



Kamlok Dichtungen

Kamlok seals



DN	Material material	Art.-Nr.
15	NBR	330 72 10 15
20	NBR	330 72 10 20
25	NBR	330 72 10 25
32	NBR	330 72 10 32
40	NBR	330 72 10 40
50	NBR	330 72 10 50
65	NBR	330 72 10 65
80	NBR	330 72 10 80
100	NBR	330 72 11 00
125	NBR	330 72 11 25
150	NBR	330 72 11 50
15	EPDM	330 72 20 15
20	EPDM	330 72 20 20
25	EPDM	330 72 20 25
32	EPDM	330 72 20 32
40	EPDM	330 72 20 40
50	EPDM	330 72 20 50
65	EPDM	330 72 20 65
80	EPDM	330 72 20 80
100	EPDM	330 72 21 00
125	EPDM	330 72 21 25
150	EPDM	330 72 21 50
15	FKM	330 72 30 15
20	FKM	330 72 30 20
25	FKM	330 72 30 25
32	FKM	330 72 30 32
40	FKM	330 72 30 40
50	FKM	330 72 30 50
65	FKM	330 72 30 65
80	FKM	330 72 30 80
100	FKM	330 72 31 00
125	FKM	330 72 31 25
150	FKM	330 72 31 50

Kamlok Reparatur-Sets

Kamlok repair-sets

für DN	Material material	Art.-Nr.
DN 20	Edelstahl	330 73 10 20
DN 25	Edelstahl	330 73 10 25
DN 50, DN 65	Edelstahl	330 73 10 50
DN 80, DN 125	Edelstahl	330 73 10 80
DN 150	Edelstahl	330 73 11 50
DN 20	Messing	330 73 30 20
DN 25	Messing	330 73 30 25
DN 50, DN 65	Messing	330 73 30 50
DN 80, DN 125	Messing	330 73 30 80
DN 150	Messing	330 73 31 50



Kamlok Ketten

Kamlok chains

Material material	Art.-Nr.
Messing	330 74 00 03
Edelstahl	330 74 00 01



Kamlok Sicherungssplinte

Kamlok circlips

Material material	Art.-Nr.
Stahl	330 74 00 10



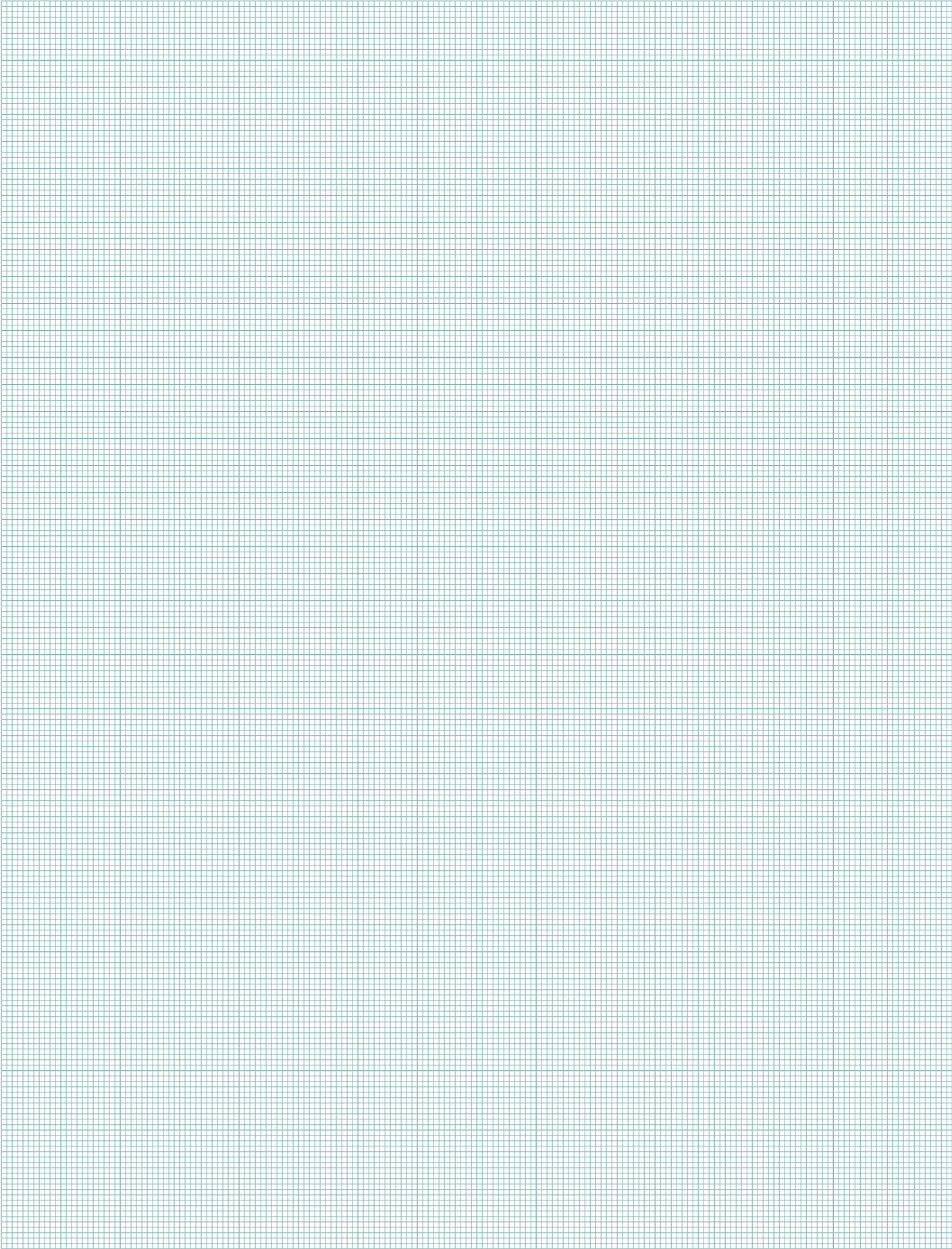

Kupplungssysteme SMS, Macon, MRV & DAS

coupling systems SMS, Macon,
MRV & DAS



SMS Mutterteile

SMS females



DN	für ÜM for union nut	Material material	Art.-Nr.
25	Rd 40X1/6"	Edelstahl	330 80 00 25
32	Rd 48X1/6"	Edelstahl	330 80 00 32
38	Rd 60X1/6"	Edelstahl	330 80 00 38
51	Rd 70X1/6"	Edelstahl	330 80 00 51
63	Rd 85X1/6"	Edelstahl	330 80 00 63
76	Rd 98X1/6"	Edelstahl	330 80 00 76
102	Rd 132X1/6"	Edelstahl	330 80 01 02

SMS Überwurfmuttern

SMS union nuts



DN	Gewinde thread	Material material	Art.-Nr.
25	Rd 40X1/6"	Edelstahl	330 82 00 25
32	Rd 48X1/6"	Edelstahl	330 82 00 32
38	Rd 60X1/6"	Edelstahl	330 82 00 38
51	Rd 70X1/6"	Edelstahl	330 82 00 51
63	Rd 85X1/6"	Edelstahl	330 82 00 63
76	Rd 98X1/6"	Edelstahl	330 82 00 76
102	Rd 132X1/6"	Edelstahl	330 82 01 02

SMS Varterteile

SMS males



DN	Gewinde thread	Material material	Art.-Nr.
25	Rd 40X1/6"	Edelstahl	330 81 00 25
32	Rd 48X1/6"	Edelstahl	330 81 00 32
38	Rd 60X1/6"	Edelstahl	330 81 00 38
51	Rd 70X1/6"	Edelstahl	330 81 00 51
63	Rd 85X1/6"	Edelstahl	330 81 00 63
76	Rd 98X1/6"	Edelstahl	330 81 00 76
102	Rd 132X1/6"	Edelstahl	330 81 01 02

SMS Dichtungen

SMS seals

DN	Material material	Art.-Nr.
25	EPDM	330 83 00 25
32	EPDM	330 83 00 32
38	EPDM	330 83 00 38
51	EPDM	330 83 00 51
63	EPDM	330 83 00 63
76	EPDM	330 83 00 76
102	EPDM	330 83 01 02



SMS Mutterteile Anschweissende

SMS females weld-on end

DN	für ÜM for union nut	Material material	Art.-Nr.
25	Rd 40X1/6"	Edelstahl	330 84 00 25
38	Rd 60X1/6"	Edelstahl	330 84 00 38
51	Rd 70X1/6"	Edelstahl	330 84 00 51
63	Rd 85X1/6"	Edelstahl	330 84 00 63
76	Rd 98X1/6"	Edelstahl	330 84 00 76
102	Rd 132X1/6"	Edelstahl	330 84 01 02



SMS Vatterteile Anschweissende

SMS males weld-on end

DN	Gewinde thread	Material material	Art.-Nr.
25	Rd 40X1/6"	Edelstahl	330 85 00 25
38	Rd 60X1/6"	Edelstahl	330 85 00 38
51	Rd 70X1/6"	Edelstahl	330 85 00 51
63	Rd 85X1/6"	Edelstahl	330 85 00 63
76	Rd 98X1/6"	Edelstahl	330 85 00 76
102	Rd 132X1/6"	Edelstahl	330 85 01 02



Macon Mutterteile mit Sicherungsbund

Macon females with safety collar



DN	Stutzen-Ø connector-Ø mm	Material material	Art.-Nr.
40	39	Edelstahl	330 90 00 40
50	51	Edelstahl	330 90 00 50
60	63	Edelstahl	330 90 00 60
70	70	Edelstahl	330 90 00 70

Macon Vaterteile mit Sicherungsbund

Macon males with safety collar



DN	Stutzen-Ø connector-Ø mm	Material material	Art.-Nr.
40	39	Edelstahl	330 91 00 40
50	51	Edelstahl	330 91 00 50
60	63	Edelstahl	330 91 00 60
70	70	Edelstahl	330 91 00 70

Macon Mutterteile ohne Sicherungsbund

Macon females without safety collar



DN	Stutzen-Ø connector-Ø mm	Material material	Art.-Nr.
40	39	Edelstahl	330 92 00 40
50	51	Edelstahl	330 92 00 50
70	70	Edelstahl	330 92 00 70

Macon Vaterteile ohne Sicherungsbund

Macon males without safety collar



DN	Stutzen-Ø connector-Ø mm	Material material	Art.-Nr.
40	39	Edelstahl	330 93 00 40
50	51	Edelstahl	330 93 00 50
70	70	Edelstahl	330 93 00 70

Macon Überwurfmuttern

Macon union nuts

DN	Material material	Art.-Nr.
40	Edelstahl	330 94 00 40
50	Edelstahl	330 94 00 50
60	Edelstahl	330 94 00 60
70	Edelstahl	330 94 00 70



Macon Dichtungen

Macon seals

DN	Material material	Art.-Nr.
40	EPDM	330 95 00 40
50	EPDM	330 95 00 50
60	EPDM	330 95 00 60
70	EPDM	330 95 00 70



Macon Mutterteile Anschweissende

Macon females weld-on end

DN	Material material	Art.-Nr.
40	Edelstahl	330 96 00 40
50	Edelstahl	330 96 00 50
60	Edelstahl	330 96 00 60
70	Edelstahl	330 96 00 70



Macon Vaterteile Anschweissende

Macon males weld-on end

DN	Material material	Art.-Nr.
40	Edelstahl	330 97 00 40
50	Edelstahl	330 97 00 50
60	Edelstahl	330 97 00 60
70	Edelstahl	330 97 00 70



MRV Kegelstutzen mit Sicherungsbund

MRV taper connector with safety collar



Gewinde nach DIN 405-1 thread according to DIN 405-1

DN	Stutzen connector mm	für ÜM for union nut	Material material	Art.-Nr.
25	25	Rd 52X1/6"	Edelstahl	330 40 00 25
32	32	Rd 58X1/6"	Edelstahl	330 40 00 32
40	38	Rd 65X1/6"	Edelstahl	330 40 00 40
50	51	Rd 78X1/6"	Edelstahl	330 40 00 50
65	63	Rd 95X1/6"	Edelstahl	330 40 00 65
80	75	Rd 110X1/4"	Edelstahl	330 40 00 80
100	100	Rd 130X1/4"	Edelstahl	330 40 01 00

MRV Kegelstutzen mit glattem Stutzen und Sicherungsbund

MRV taper connector with smooth connector an safety collar



Gewinde nach DIN 405-1 thread according to DIN 405-1

DN	Stutzen connector mm	für ÜM for union nut	Material material	Art.-Nr.
25	25	Rd 52X1/6"	Edelstahl	330 42 00 25
32	32	Rd 58X1/6"	Edelstahl	330 42 00 32
40	38	Rd 65X1/6"	Edelstahl	330 42 00 40
50	51	Rd 78X1/6"	Edelstahl	330 42 00 50
65	63	Rd 95X1/6"	Edelstahl	330 42 00 65
80	75	Rd 110X1/4"	Edelstahl	330 42 00 80
100	100	Rd 130X1/4"	Edelstahl	330 42 01 00

MRV Überwurfmuttern

MRV union nuts



Gewinde nach DIN 405-1 thread according to DIN 405-1

DN	für ÜM for union nut	Material material	Art.-Nr.
25	Rd 52X1/6"	Edelstahl	330 44 00 25
32	Rd 58X1/6"	Edelstahl	330 44 00 32
40	Rd 65X1/6"	Edelstahl	330 44 00 40
50	Rd 78X1/6"	Edelstahl	330 44 00 50
65	Rd 95X1/6"	Edelstahl	330 44 00 65
80	Rd 110X1/4"	Edelstahl	330 44 00 80
100	Rd 130X1/4"	Edelstahl	330 44 01 00

MRV Außengewindenippel mit Sicherungsbund

MRV external thread nipple with safety collar

Gewinde nach DIN 405-1 thread according to DIN 405-1

DN	Stutzen connector mm	für ÜM for union nut	Material material	Art.-Nr.
25	25	Rd 52X1/6"	Edelstahl	330 41 00 25
32	32	Rd 58X1/6"	Edelstahl	330 41 00 32
40	38	Rd 65X1/6"	Edelstahl	330 41 00 40
50	51	Rd 78X1/6"	Edelstahl	330 41 00 50
65	63	Rd 95X1/6"	Edelstahl	330 41 00 65
80	75	Rd 110X1/4"	Edelstahl	330 41 00 80
100	100	Rd 130X1/4"	Edelstahl	330 41 01 00



MRV Außengewindenippel mit glattem Stutzen und Sicherungsbund

MRV external thread nipple with smooth connector an safety collar

Gewinde nach DIN 405-1 thread according to DIN 405-1

DN	Stutzen connector mm	für ÜM for union nut	Material material	Art.-Nr.
25	25	Rd 52X1/6"	Edelstahl	330 43 00 25
32	32	Rd 58X1/6"	Edelstahl	330 43 00 32
40	38	Rd 65X1/6"	Edelstahl	330 43 00 40
50	51	Rd 78X1/6"	Edelstahl	330 43 00 50
65	63	Rd 95X1/6"	Edelstahl	330 43 00 65
80	75	Rd 110X1/4"	Edelstahl	330 43 00 80
100	100	Rd 130X1/4"	Edelstahl	330 43 01 00



MRV Dichtungen

MRV seals

DN	Art.-Nr.
25	330 45 00 25
32	330 45 00 32
40	330 45 00 40
50	330 45 00 50
65	330 45 00 65
80	330 45 00 80
100	330 45 01 00



DAS Außengewindenippel mit Sicherungsbund nach DIN 2826

DAS external thread nipple with safety collar according to DIN 2826



DN	Inch	Gewinde thread	Material material	Art.-Nr.
12	1/2"	G 1/2"	Stahl	331 01 12 34
20	3/4"	G 3/4"	Stahl	331 01 20 36
25	1"	G 1"	Stahl	331 01 25 37
32	1 1/4"	G 1 1/4"	Stahl	331 01 32 38
40	1 1/2"	G 1 1/2"	Stahl	331 01 40 39
50	2"	G 2"	Stahl	331 01 50 40
12	1/2"	G 1/2"	Edelstahl	331 01 12 34v
20	3/4"	G 3/4"	Edelstahl	331 01 20 36v
25	1"	G 1"	Edelstahl	331 01 25 37v
32	1 1/4"	G 1 1/4"	Edelstahl	331 01 32 38v
40	1 1/2"	G 1 1/2"	Edelstahl	331 01 40 39v
50	2"	G 2"	Edelstahl	331 01 50 40v

DAS Innengewindenippel mit Sicherungsbund nach DIN 2826

DAS internal thread nipple with safety collar according to DIN 2826



DN	Inch	Gewinde thread	Material material	Art.-Nr.
12	1/2"	R 1/2"	Stahl	331 02 12 34
20	3/4"	R 3/4"	Stahl	331 02 20 36
25	1"	R 1"	Stahl	331 02 25 37
32	1 1/4"	R 1 1/4"	Stahl	331 02 32 38
40	1 1/2"	R 1 1/2"	Stahl	331 02 40 39
50	2"	R 2"	Stahl	331 02 50 40
12	1/2"	R 1/2"	Edelstahl	331 02 12 34v
20	3/4"	R 3/4"	Edelstahl	331 02 20 36v
25	1"	R 1"	Edelstahl	331 02 25 37v
32	1 1/4"	R 1 1/4"	Edelstahl	331 02 32 38v
40	1 1/2"	R 1 1/2"	Edelstahl	331 02 40 39v
50	2"	R 2"	Edelstahl	331 02 50 40v

Storz-Kupplungen

Storz coupling system



Storz mit langem Stutzen

Storz with long connector



Knaggenabstand distance of fixture mm	Stutzen-Ø connector-Ø mm	Art.-Nr.
31	25	331 10 25 25
44	25	331 10 25 38
44	32	331 10 32 38
44	38	331 10 38 38
66	32	331 10 32 50
66	38	331 10 38 50
66	42	331 10 42 50
66	45	331 10 45 50
66	52	331 10 50 50
81	38	331 10 38 65
81	50	331 10 63 65
81	63	331 10 53 65
81	65	331 10 65 65
81	70	331 10 70 65
89	52	331 10 52 75
89	63	331 10 63 75
89	70	331 10 70 75
89	75	331 10 75 75
115	100	331 10 90 90
133	100	331 10 93 90
133	110	331 10 95 90
148	125	331 10 95 95

Storz mit Außengewinde

Storz with external thread



Knaggenabstand distance of fixture mm	Außengewinde external thread	Art.-Nr.
31	G 3/4"	331 11 25 36
31	G 1"	331 11 25 37
31	G 1 1/4"	331 11 25 38
31	G 1 1/2"	331 11 25 39
51	G 1 1/4"	331 11 38 38
51	G 1 1/2"	331 11 38 39
51	G 2"	331 11 38 40
59	G 2"	331 11 45 40
66	G 1"	331 11 50 37
66	G 1 1/4"	331 11 50 38
66	G 1 1/2"	331 11 50 39
66	G 2"	331 11 50 40
66	G 2 1/2"	331 11 50 41
81	G 1 1/4"	331 11 65 38
81	G 1 1/2"	331 11 65 39
81	G 2"	331 11 65 40
81	G 2 1/2"	331 11 65 41
81	G 3"	331 11 65 43
89	G 2"	331 11 75 40
89	G 2 1/2"	331 11 75 41
89	G 3"	331 11 75 43
133	G 4"	331 11 93 44
133	G 5"	331 11 93 45
148	G 5"	331 11 95 45

Storz mit Innengewinde

Storz with internal thread

Knaggenabstand distance of fixture mm	Innengewinde thread	Art.-Nr.
31	R 1/2"	331 12 25 34
31	R 3/4"	331 12 25 36
31	R 1"	331 12 25 37
31	R 1 1/4"	331 12 25 38
51	R 1"	331 12 38 37
51	R 1 1/4"	331 12 38 38
51	R 1 1/2"	331 12 38 39
51	R 2"	331 12 38 40
59	R 1 1/2"	331 12 45 39
59	R 2"	331 12 45 40
66	R 3/4"	331 12 50 36
66	R 1"	331 12 50 37
66	R 1 1/4"	331 12 50 38
66	R 1 1/2"	331 12 50 39
66	R 2"	331 12 50 40
66	R 2 1/2"	331 12 50 41
81	R 1"	331 12 65 37
81	R 1 1/4"	331 12 65 38
81	R 1 1/2"	331 12 65 39
81	R 2"	331 12 65 40
81	R 2 1/2"	331 12 65 41
81	R 3"	331 12 65 43
89	R 2"	331 12 75 40
89	R 2 1/2"	331 12 75 41
89	R 3"	331 12 75 43
133	R 3"	331 12 93 43
133	R 4"	331 12 93 44
133	R 4 1/2"	331 12 93 45
133	R 5"	331 12 93 46
148	R 5"	331 12 95 46



Storz Blindkupplungen mit Kette

Storz blank caps with chain

Knaggenabstand distance of fixture mm	Art.-Nr.
31	331 13 00 25
51	331 13 00 38
59	331 13 00 45
66	331 13 00 50
81	331 13 00 65
89	331 13 00 75
115	331 13 01 00
133	331 13 01 10
148	331 13 01 25



Storz Reduzier-Kupplungen

Storz reducing couplings



Knaggenabstand distance of fixture mm	Knaggenabstand distance of fixture mm	Art.-Nr.
59	31	331 14 45 25
66	31	331 14 50 25
81	59	331 14 65 45
81	66	331 14 65 50
89	66	331 14 75 50
89	81	331 14 75 65
133	66	331 14 93 50
133	81	331 14 93 65
133	89	331 14 93 75
133	115	331 14 93 90
148	133	331 14 95 93

Storz Dichtungen

Storz seals



Knaggenabstand distance of fixture mm	Material material	Art.-Nr.
31	NBR schwarz	331 15 10 25
44	NBR schwarz	331 15 10 32
51	NBR schwarz	331 15 10 38
66	NBR schwarz	331 15 10 50
81	NBR schwarz	331 15 10 65
89	NBR schwarz	331 15 10 75
105	NBR schwarz	331 15 10 90
115	NBR schwarz	331 15 11 00
133	NBR schwarz	331 15 11 10
31	NBR weiß	331 15 20 25
44	NBR weiß	331 15 20 32
51	NBR weiß	331 15 20 38
66	NBR weiß	331 15 20 50
81	NBR weiß	331 15 20 65
89	NBR weiß	331 15 20 75
105	NBR weiß	331 15 20 90
115	NBR weiß	331 15 21 00
133	NBR weiß	331 15 21 10

Guillemin-Kupplungen

Guillemin couplings



Guillemin mit Stutzen und Arretierung

Guillemin with connector and locking



Innen-Ø internal-Ø mm	Nippel-Ø nipple-Ø mm	Material material	Art.-Nr.
15	20	Edelstahl	331 20 15 20v
20	25	Edelstahl	331 20 20 25v
25	30	Edelstahl	331 20 25 30v
32	35	Edelstahl	331 20 32 35v
40	40	Edelstahl	331 20 40 40v
40	45	Edelstahl	331 20 45 45v
50	50	Edelstahl	331 20 50 50v
50	55	Edelstahl	331 20 50 55v
65	64	Edelstahl	331 20 65 64v
65	70	Edelstahl	331 20 65 70v
80	76	Edelstahl	331 20 80 76v
80	80	Edelstahl	331 20 80 80v
80	90	Edelstahl	331 20 80 90v
100	102	Edelstahl	331 20 90 10v
100	110	Edelstahl	331 20 90 11v
20	25	Aluminium	331 20 25 20
25	30	Aluminium	331 20 25 30
25	25	Aluminium	331 20 25 25
32	35	Aluminium	331 20 32 35
40	40	Aluminium	331 20 40 40
40	35	Aluminium	331 20 40 35
40	45	Aluminium	331 20 40 45
50	50	Aluminium	331 20 50 50
50	55	Aluminium	331 20 50 55
65	64	Aluminium	331 20 65 64
65	70	Aluminium	331 20 65 70
80	76	Aluminium	331 20 80 76
80	81	Aluminium	331 20 80 81
80	90	Aluminium	331 20 80 90
100	100	Aluminium	331 20 90 90
100	102	Aluminium	331 20 90 92
100	105	Aluminium	331 20 90 95
100	110	Aluminium	331 20 90 97
125	125	Aluminium	331 20 93 93
150	152	Aluminium	331 20 95 52

Guillemin mit Stutzen und Arretierung, ohne Knaggen

Guillemin with connector and locking, without lugs



Innen-Ø internal-Ø mm	Nippel-Ø nipple-Ø mm	Material material	Art.-Nr.
50	50	Aluminium	331 21 50 50
80	76	Aluminium	331 21 80 76
80	90	Aluminium	331 21 80 90
100	102	Aluminium	331 21 90 12

Guillemin mit Außengewinde und Arretierung

Guillemin with external thread and locking



Innen-Ø internal-Ø mm	Außengewinde external thread	Material material	Art.-Nr.
15	G 1/2"	Edelstahl	331 22 15 34v
20	G 3/4"	Edelstahl	331 22 20 36v
25	G 1"	Edelstahl	331 22 25 37v
32	G 1 1/4"	Edelstahl	331 22 32 38v
40	G 1 1/2"	Edelstahl	331 22 40 39v
50	G 2"	Edelstahl	331 22 50 40v
65	G 2 1/2"	Edelstahl	331 22 65 41v
80	G 3"	Edelstahl	331 22 80 42v
100	G 4"	Edelstahl	331 22 90 43v
20	G 3/4"	Aluminium	331 22 20 36
25	G 1"	Aluminium	331 22 25 37
32	G 1 1/4"	Aluminium	331 22 32 38
40	G 1 1/2"	Aluminium	331 22 40 39
50	G 1 1/2"	Aluminium	331 22 50 39
50	G 2"	Aluminium	331 22 50 40
65	G 2"	Aluminium	331 22 65 40
65	G 2 1/2"	Aluminium	331 22 65 51
80	G 2 1/2"	Aluminium	331 22 80 41
80	G 3"	Aluminium	331 22 80 42
100	G 4"	Aluminium	331 22 90 43
125	G 5"	Aluminium	331 22 93 44
150	G 6"	Aluminium	331 22 95 45

Guillemin mit Innengewinde und Arretierung

Guillemin with internal thread and locking



Innen-Ø internal-Ø mm	Innengewinde internal thread	Material material	Art.-Nr.
15	R 1/2"	Edelstahl	331 23 15 34v
20	R 3/4"	Edelstahl	331 23 20 36v
25	R 1"	Edelstahl	331 23 25 37v
32	R 1 1/4"	Edelstahl	331 23 32 38v
40	R 1 1/2"	Edelstahl	331 23 40 39v
50	R 2"	Edelstahl	331 23 50 40v
65	R 2 1/2"	Edelstahl	331 23 65 41v
80	R 3"	Edelstahl	331 23 80 42v
100	R 4"	Edelstahl	331 23 90 43v
20	R 3/4"	Aluminium	331 23 20 36
25	R 1"	Aluminium	331 23 25 37
32	R 1 1/4"	Aluminium	331 23 32 38
40	R 1 1/2"	Aluminium	331 23 40 39
50	R 1 1/2"	Aluminium	331 23 50 39
50	R 2"	Aluminium	331 23 50 40
65	R 2"	Aluminium	331 23 65 40
65	R 2 1/2"	Aluminium	331 23 65 41
80	R 2 1/2"	Aluminium	331 23 80 41
80	R 3"	Aluminium	331 23 80 42
100	R 4"	Aluminium	331 23 90 43
125	R 5"	Aluminium	331 23 93 44
150	R 6"	Aluminium	331 23 95 45

Guillemin mit Außengewinde

Guillemin with external thread



Innen-Ø internal-Ø mm	Außengewinde external thread	Material material	Art.-Nr.
15	G 1/2"	Edelstahl	331 24 15 34v
20	G 3/4"	Edelstahl	331 24 20 36v
25	G 1"	Edelstahl	331 24 25 37v
32	G 1 1/4"	Edelstahl	331 24 32 38v
40	G 1 1/2"	Edelstahl	331 24 40 39v
50	G 2"	Edelstahl	331 24 50 40v
65	G 2 1/2"	Edelstahl	331 24 65 41v
80	G 3"	Edelstahl	331 24 80 42v
100	G 4"	Edelstahl	331 24 90 43v
20	G 3/4"	Aluminium	331 24 20 36
25	G 1"	Aluminium	331 24 25 37
32	G 1 1/4"	Aluminium	331 24 32 38
40	G 1 1/2"	Aluminium	331 24 40 39
50	G 2"	Aluminium	331 24 50 40
65	G 2 1/2"	Aluminium	331 24 65 41
80	G 3"	Aluminium	331 24 80 42
100	G 4"	Aluminium	331 24 90 43

Guillemin mit Innengewinde

Guillemin with internal thread



Innen-Ø internal-Ø mm	Innengewinde internal thread	Material material	Art.-Nr.
15	R 1/2"	Edelstahl	331 25 15 34v
20	R 3/4"	Edelstahl	331 25 20 36v
25	R 1"	Edelstahl	331 25 25 37v
32	R 1 1/4"	Edelstahl	331 25 32 38v
40	R 1 1/2"	Edelstahl	331 25 40 39v
50	R 2"	Edelstahl	331 25 50 40v
65	R 2 1/2"	Edelstahl	331 25 65 41v
80	R 3"	Edelstahl	331 25 80 42v
100	R 4"	Edelstahl	331 25 90 43v
20	R 3/4"	Aluminium	331 25 20 36
25	R 1"	Aluminium	331 25 25 37
32	R 1 1/4"	Aluminium	331 25 32 38
40	R 1 1/2"	Aluminium	331 25 40 39
50	R 2"	Aluminium	331 25 50 40
65	R 2 1/2"	Aluminium	331 25 65 41
80	R 3"	Aluminium	331 25 80 42
100	R 4"	Aluminium	331 25 90 43

Guillemin Reduzier-Kupplung

Guillemin reducing coupling

Innen-Ø internal-Ø mm	Innen-Ø internal-Ø mm	Material material	Art.-Nr.
40	20	Edelstahl	331 26 40 20v
40	25	Edelstahl	331 26 40 25v
40	32	Edelstahl	331 26 40 32v
50	40	Edelstahl	331 26 50 40v
65	40	Edelstahl	331 26 65 40v
65	50	Edelstahl	331 26 65 50v
80	40	Edelstahl	331 26 80 40v
80	50	Edelstahl	331 26 80 50v
80	65	Edelstahl	331 26 80 65v
100	40	Edelstahl	331 26 90 40v
100	50	Edelstahl	331 26 90 50v
100	65	Edelstahl	331 26 90 65v
100	80	Edelstahl	331 26 90 80v
25	20	Aluminium	331 26 25 20
32	20	Aluminium	331 26 32 20
32	25	Aluminium	331 26 32 25
40	20	Aluminium	331 26 40 20
40	25	Aluminium	331 26 40 25
40	32	Aluminium	331 26 40 32
50	25	Aluminium	331 26 50 25
50	32	Aluminium	331 26 50 32
50	40	Aluminium	331 26 50 40
65	40	Aluminium	331 26 65 40
65	50	Aluminium	331 26 65 50
80	40	Aluminium	331 26 80 40
80	50	Aluminium	331 26 80 50
80	65	Aluminium	331 26 80 65
100	40	Aluminium	331 26 90 40
100	50	Aluminium	331 26 90 50
100	65	Aluminium	331 26 90 65
100	80	Aluminium	331 26 90 80
150	100	Aluminium	331 26 95 90



Guillemin Blindkupplung mit Arretierung

Guillemin blank cap with locking



Innen-Ø internal-Ø mm	Material material	Art.-Nr.
15	Edelstahl	331 27 00 15v
20	Edelstahl	331 27 00 20v
25	Edelstahl	331 27 00 25v
32	Edelstahl	331 27 00 32v
40	Edelstahl	331 27 00 40v
50	Edelstahl	331 27 00 50v
65	Edelstahl	331 27 00 65v
80	Edelstahl	331 27 00 80v
100	Edelstahl	331 27 01 00v
20	Aluminium	331 27 00 20
25	Aluminium	331 27 00 25
32	Aluminium	331 27 00 32
40	Aluminium	331 27 00 40
50	Aluminium	331 27 00 50
65	Aluminium	331 27 00 65
80	Aluminium	331 27 00 80
100	Aluminium	331 27 01 00
150	Aluminium	331 27 01 50

Adapter Guillemin - französisch Express

adapter Guillemin - french express

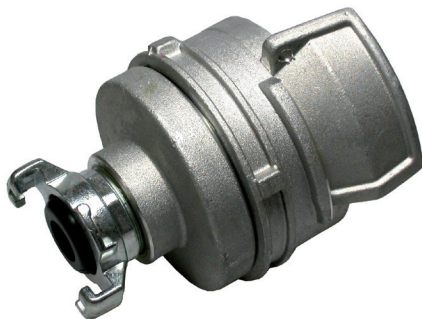

Innen-Ø internal-Ø mm	Material material	Art.-Nr.
40	Messing	331 28 00 40
50	Messing	331 28 00 50
65	Messing	331 28 00 65
80	Messing	331 28 00 80
DSP 40	Messing	331 28 00 90
DSP 65	Messing	331 28 00 94

Adapter Guillemin - SMS

adapter Guillemin - SMS



Innen-Ø internal-Ø mm	für ÜM for union nut	Material material	Art.-Nr.
50	Rd 70X1/6"	Edelstahl	331 29 50 51
80	Rd 98X1/6"	Edelstahl	331 29 80 76

Adapter Guillemin - MRV

adapter Guillemin - MRV

Innen-Ø internal-Ø mm	für ÜM for union nut	Material material	Art.-Nr.
50	Rd 78X1/6"	Edelstahl	331 30 50 50
80	Rd 110X1/4"	Edelstahl	331 30 80 80

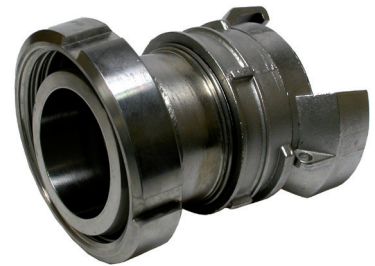

Adapter Guillemin - Storz

adapter Guillemin - Storz

Innen-Ø internal-Ø mm	Knaggenabstand distance of fixture mm	Material material	Art.-Nr.
50	52	Aluminium	331 31 50 52
80	75	Aluminium	331 31 80 75
80	75 mit Arretierung	Aluminium	331 31 80 76
100	110	Aluminium	331 31 90 93
100	110 drehbar	Aluminium	331 31 90 94

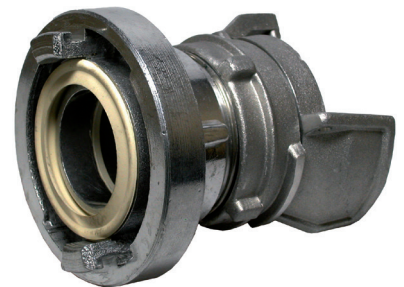

Guillemin Dichtungen

Guillemin seals



Innen-Ø internal-Ø mm	Material material	Art.-Nr.
15	NBR schwarz	331 32 10 15
20	NBR schwarz	331 32 10 20
25	NBR schwarz	331 32 10 25
32	NBR schwarz	331 32 10 32
40	NBR schwarz	331 32 10 40
50	NBR schwarz	331 32 10 50
65	NBR schwarz	331 32 10 65
80	NBR schwarz	331 32 10 80
100	NBR schwarz	331 32 11 00
150	NBR schwarz	331 32 10 50
15	EPDM weiß	331 32 20 15
20	EPDM weiß	331 32 20 20
25	EPDM weiß	331 32 20 25
32	EPDM weiß	331 32 20 32
40	EPDM weiß	331 32 20 40
50	EPDM weiß	331 32 20 50
65	EPDM weiß	331 32 20 65
80	EPDM weiß	331 32 20 80
100	EPDM weiß	331 32 21 00
150	EPDM weiß	331 32 21 50
20	FKM schwarz	331 32 30 20
25	FKM schwarz	331 32 30 25
32	FKM schwarz	331 32 30 32
40	FKM schwarz	331 32 30 40
50	FKM schwarz	331 32 30 50
65	FKM schwarz	331 32 30 65
80	FKM schwarz	331 32 30 80
100	FKM schwarz	331 32 31 00
20	PTFE weiß	331 32 40 20
25	PTFE weiß	331 32 40 25
32	PTFE weiß	331 32 40 32
40	PTFE weiß	331 32 40 40
50	PTFE weiß	331 32 40 50
65	PTFE weiß	331 32 40 65
80	PTFE weiß	331 32 40 80
100	PTFE weiß	331 32 41 00

Kupplungssysteme Perrot & Bauer

coupling systems
Perrot & Bauer



Perrot Vatterteile

Perrot males



Inch	Stutzen-Ø connector-Ø mm	Art.-Nr.
2"	51	331 33 10 51
2 1/2"	63	331 33 10 63
3"	76	331 33 10 76
4"	102	331 33 11 02
5"	127	331 33 11 27
6"	152	331 33 11 52
8"	202	331 33 12 02

Perrot Mutterteile

Perrot females



Inch	Stutzen-Ø connector-Ø mm	Art.-Nr.
2"	51	331 33 00 51
2 1/2"	63	331 33 00 63
3"	76	331 33 00 76
4"	102	331 33 01 02
5"	127	331 33 01 27
6"	152	331 33 01 52
8"	202	331 33 02 02

Perrot Dichtungen

Perrot seals



Inch	Stutzen-Ø connector-Ø mm	Art.-Nr.
2"	51	331 33 20 51
2 1/2"	63	331 33 20 63
3"	76	331 33 20 76
4"	102	331 33 21 02
5"	127	331 33 21 27
6"	152	331 33 21 52
8"	202	331 33 22 02

Bauer Vatterteile

Bauer males

Inch	Stutzen-Ø connector-Ø mm	Art.-Nr.
2"	51	331 34 10 51
3"	76	334 34 10 76
3 1/2"	90	334 34 10 90
4"	102	334 34 11 02
6"	152	334 34 11 52
8"	202	334 34 12 02
10"	252	334 34 12 52
12"	302	334 34 13 02



Bauer Mutterteile

Bauer females

Inch	Stutzen-Ø connector-Ø mm	Art.-Nr.
2"	51	331 34 00 51
3"	76	331 34 00 76
3 1/2"	90	331 34 00 90
4"	102	331 34 01 02
6"	152	331 34 01 52
8"	202	331 34 02 02
10"	252	331 34 02 52
12"	302	331 34 03 02



Bauer Dichtungen

Bauer seals

Inch	Stutzen-Ø connector-Ø mm	Art.-Nr.
2"	51	334 34 20 51
3"	76	334 34 20 76
3 1/2"	90	334 34 20 90
4"	102	334 34 21 02
6"	152	334 34 21 52
8"	202	334 34 22 02
10"	252	334 34 22 52
12"	302	334 34 23 02



Bauer Hebel

Bauer levers



Inch	Art.-Nr.
2"	331 34 30 51
3"	331 34 30 76
3 1/2"	331 34 30 90
4"	331 34 31 02
6"	331 34 31 52
8"	331 34 32 02
10"	331 34 32 52
12"	331 34 33 02

Montageschlüssel

mounting wrenches



SMS/Macon Montagehebel

SMS/Macon assembly lever

	Art.-Nr.
SGE	331 99 00 01



Spannschlüssel Storz/Guillemain

chuck key Storz/Guillemain

	Art.-Nr.
System Storz	331 99 00 02
SGB DN 50-100	331 99 00 03
SGC DN 20-115	331 99 00 04
SGD DN 50-100	331 99 00 05
SGG DN 50-100	331 99 00 06
SGH DN 50-100	331 99 00 07
SGI DN 20-65	331 99 00 08



Adapter

adapters

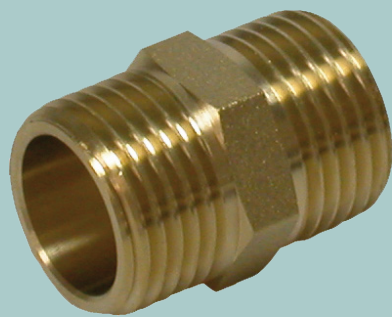

Nippel mit BSPT-Gewinde

connector with BSPT-thread

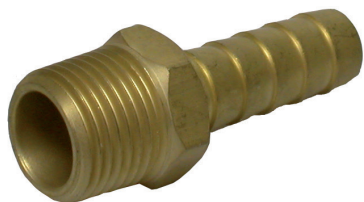

Gewinde thread	Stutzen-Ø connector-Ø mm	Material material	Art.-Nr.
R 1/8"	3,0	Messing	333 19 03 51
R 1/4"	6,0	Messing	333 19 06 52
R 3/8"	9,5	Messing	333 19 10 52
R 1/2"	12,7	Messing	333 19 12 54
R 3/4"	19,4	Messing	333 19 20 56
R 1"	25,4	Messing	333 19 25 57

Nippel mit BSPP-Gewinde

connector with BSPP-thread



Gewinde thread	Stutzen-Ø connector-Ø mm	Material material	Art.-Nr.
G 1/8"	3,0	Messing	333 20 03 31
G 1/4"	6,0	Messing	333 20 06 32
G 3/8"	9,5	Messing	333 20 10 22
G 1/2"	12,7	Messing	333 20 12 34
G 3/4"	19,4	Messing	333 20 20 36
G 1"	25,4	Messing	333 20 25 37
G 1 1/4"	32,0	Messing	333 20 32 38
G 1 1/2"	38,0	Messing	333 20 38 39
G 2"	50,7	Messing	333 20 50 40

Nippel mit BSPP-Überwurfmutter

connector with BSPP-union nut



Gewinde thread	Stutzen-Ø connector-Ø mm	Material material	Art.-Nr.
R 1/8"	3,0	Messing	333 21 03 31
R 1/4"	6,0	Messing	333 21 06 32
R 3/8"	9,5	Messing	333 21 10 22
R 1/2"	12,7	Messing	333 21 12 34
R 3/4"	19,4	Messing	333 21 20 36
R 1"	25,4	Messing	333 21 25 37
R 1 1/4"	32,0	Messing	333 21 32 38
R 1 1/2"	38,0	Messing	333 21 38 39
R 2"	50,7	Messing	333 21 50 40

Doppelstutzen

double connector

Gewinde 1 thread 1	Gewinde 2 thread 2	Material material	Art.-Nr.
G 1/8"	G 1/8"	Messing	333 22 31 31
G 1/8"	G 1/4"	Messing	333 22 32 31
G 1/4"	G 1/4"	Messing	333 22 32 32
G 1/4"	G 3/8"	Messing	333 22 33 32
G 1/4"	G 1/2"	Messing	333 22 34 32
G 3/8"	G 3/8"	Messing	333 22 33 33
G 3/8"	G 1/2"	Messing	333 22 34 33
G 3/8"	G 3/4"	Messing	333 22 36 33
G 1/2"	G 1/2"	Messing	333 22 34 34
G 1/2"	G 3/4"	Messing	333 22 36 34
G 1/2"	G 1"	Messing	333 22 37 34
G 3/4"	G 3/4"	Messing	333 22 36 36
G 3/4"	G 1"	Messing	333 22 37 36
G 1"	G 1"	Messing	333 22 37 37
G 1 1/4"	G 1 1/4"	Messing	333 22 38 38
G 1 1/2"	G 1 1/2"	Messing	333 22 39 39
G 2"	G 2"	Messing	333 22 40 40
G 3"	G 3"	Messing	333 22 41 41



Gewindereduzierung

thread reduction

Außengewinde external thread	Innengewinde internal thread	Material material	Art.-Nr.
G 1/4"	R 1/8"	Messing	333 38 32 31
G 3/8"	R 1/8"	Messing	333 38 33 31
G 3/8"	R 1/4"	Messing	333 38 33 32
G 1/2"	R 1/8"	Messing	333 38 34 31
G 1/2"	R 1/4"	Messing	333 38 34 32
G 1/2"	R 3/8"	Messing	333 38 34 33
G 3/4"	R 3/8"	Messing	333 38 36 33
G 3/4"	R 1/2"	Messing	333 38 36 34
G 1"	R 1/2"	Messing	333 38 37 34
G 1"	R 3/4"	Messing	333 38 37 36



Muffen

sockets

Gewinde thread	Material material	Art.-Nr.
R 1/8"	Messing	333 23 31 31
R 1/4"	Messing	333 23 32 32
R 3/8"	Messing	333 23 33 33
R 1/2"	Messing	333 23 34 34
R 3/4"	Messing	333 23 36 36
R 1"	Messing	333 23 37 37
R 1 1/4"	Messing	333 23 38 38
R 1 1/2"	Messing	333 23 39 39
R 2"	Messing	333 23 40 40
R 3"	Messing	333 23 41 41



Muffen 90° sockets 90°



Gewinde thread	Material material	Art.-Nr.
R 1/8"	Messing	333 39 31 31
R 1/4"	Messing	333 39 32 32
R 3/8"	Messing	333 39 33 33
R 1/2"	Messing	333 39 34 34
R 3/4"	Messing	333 39 36 36
R 1"	Messing	333 39 37 37

T-Muffen tee screw connection



Gewinde thread	Material material	Art.-Nr.
R 1/8"	Messing	333 40 31 31
R 1/4"	Messing	333 40 32 32
R 3/8"	Messing	333 40 33 33
R 1/2"	Messing	333 40 34 34
R 3/4"	Messing	333 40 36 36
R 1"	Messing	333 40 37 37

Doppelstutzen double connector



Gewinde 1 thread 1	Gewinde 2 thread 2	Material material	Art.-Nr.
G 1/2"	G 1/2"	Edelstahl	333 24 34 34
G 3/4"	G 3/4"	Edelstahl	333 24 36 36
G 1"	G 1"	Edelstahl	333 24 37 37
G 1 1/4"	G 1 1/4"	Edelstahl	333 24 38 38
G 1 1/2"	G 1 1/2"	Edelstahl	333 24 39 39
G 2"	G 2"	Edelstahl	333 24 40 40
G 2 1/2"	G 2 1/2"	Edelstahl	333 24 41 41
G 3"	G 3"	Edelstahl	333 24 42 42
G 4"	G 4"	Edelstahl	333 24 43 43
G 1 1/2"	G 1"	Edelstahl	333 24 39 40
G 2"	G 1"	Edelstahl	333 24 40 37
G 3"	G 1"	Edelstahl	333 24 41 37
G 3"	G 2"	Edelstahl	333 24 41 40

Muffen sockets

Gewinde thread	Material material	Art.-Nr.
R 1 1/2"	Edelstahl	333 25 39 39
R 2"	Edelstahl	333 25 40 40
R 2 1/2"	Edelstahl	333 25 41 41
R 3"	Edelstahl	333 25 42 42
R 4"	Edelstahl	333 25 43 43



Muffen 90° angle sockets 90°

Gewinde thread	Material material	Art.-Nr.
R 1/8"	Edelstahl	333 26 31 31
R 1/4"	Edelstahl	333 26 32 32
R 3/8"	Edelstahl	333 26 33 33
R 1/2"	Edelstahl	333 26 34 34
R 3/4"	Edelstahl	333 26 36 36
R 1"	Edelstahl	333 26 37 37
R 1 1/4"	Edelstahl	333 26 38 38
R 1 1/2"	Edelstahl	333 26 39 39
R 2"	Edelstahl	333 26 40 40
R 2 1/2"	Edelstahl	333 26 41 41
R 3"	Edelstahl	333 26 42 42
R 4"	Edelstahl	333 26 43 43



Aufschraubmuffen 90° screw-on angle sockets 90°

Innengewinde internal thread	Aussengewinde external thread	Material material	Art.-Nr.
R 1/8"	G 1/8"	Edelstahl	333 27 31 31
R 1/4"	G 1/4"	Edelstahl	333 27 32 32
R 3/8"	G 3/8"	Edelstahl	333 27 33 33
R 1/2"	G 1/2"	Edelstahl	333 27 34 34
R 3/4"	G 3/4"	Edelstahl	333 27 36 36
R 1"	G 1"	Edelstahl	333 27 37 37
R 1 1/4"	G 1 1/4"	Edelstahl	333 27 38 38
R 1 1/2"	G 1 1/2"	Edelstahl	333 27 39 39
R 2"	G 2"	Edelstahl	333 27 40 40



T-Muffen

tee screw connections



Gewinde thread	Material material	Art.-Nr.
R 1/8"	Edelstahl	333 29 31 31
R 1/4"	Edelstahl	333 29 32 32
R 3/8"	Edelstahl	333 29 33 33
R 1/2"	Edelstahl	333 29 34 34
R 3/4"	Edelstahl	333 29 36 36
R 1"	Edelstahl	333 29 37 37
R 1 1/4"	Edelstahl	333 29 38 38
R 1 1/2"	Edelstahl	333 29 39 39
R 2"	Edelstahl	333 29 40 40
R 2 1/2"	Edelstahl	333 29 41 41
R 3"	Edelstahl	333 29 42 42
R 4"	Edelstahl	333 29 43 43

Reduziermuffen

reduce sockets



Gewinde 1 thread 1	Gewinde 2 thread 2	Material material	Art.-Nr.
R 1/4"	R 1/8"	Edelstahl	333 30 32 31
R 3/8"	R 1/8"	Edelstahl	333 30 33 31
R 3/8"	R 1/4"	Edelstahl	333 30 33 32
R 1/2"	R 1/4"	Edelstahl	333 30 34 32
R 1/2"	R 3/8"	Edelstahl	333 30 34 33
R 3/4"	R 1/4"	Edelstahl	333 30 36 32
R 3/4"	R 3/8"	Edelstahl	333 30 36 33
R 3/4"	R 1/2"	Edelstahl	333 30 36 34
R 1"	R 1/4"	Edelstahl	333 30 37 32
R 1"	R 3/8"	Edelstahl	333 30 37 33
R 1"	R 1/2"	Edelstahl	333 30 37 34
R 1"	R 3/4"	Edelstahl	333 30 37 36
R 1 1/4"	R 1/2"	Edelstahl	333 30 38 34
R 1 1/4"	R 3/4"	Edelstahl	333 30 38 36
R 1 1/4"	R 1"	Edelstahl	333 30 38 37
R 1 1/2"	R 3/4"	Edelstahl	333 30 39 36
R 1 1/2"	R 1"	Edelstahl	333 30 39 37
R 1 1/2"	R 1 1/4"	Edelstahl	333 30 39 38
R 2"	R 3/4"	Edelstahl	333 30 40 36
R 2"	R 1"	Edelstahl	333 30 40 47
R 2"	R 1 1/4"	Edelstahl	333 30 40 38
R 2"	R 1 1/2"	Edelstahl	333 30 40 39
R 2 1/2"	R 1 1/2"	Edelstahl	333 30 41 39
R 2 1/2"	R 2"	Edelstahl	333 30 41 40
R 3"	R 2"	Edelstahl	333 30 42 40
R 3"	R 2 1/2"	Edelstahl	333 30 42 41
R 4"	R 2"	Edelstahl	333 30 43 40
R 4"	R 2 1/2"	Edelstahl	333 30 43 41

Gewindereduzierungen

thread reductions

Aussengewinde external thread	Innengewinde internal thread	Material material	Art.-Nr.
R 1/4"	G 1/8"	Edelstahl	333 31 32 31
R 3/8"	G 1/8"	Edelstahl	333 31 33 31
R 3/8"	G 1/4"	Edelstahl	333 31 33 32
R 1/2"	G 1/8"	Edelstahl	333 31 34 31
R 1/2"	G 1/4"	Edelstahl	333 31 34 32
R 1/2"	G 3/8"	Edelstahl	333 31 34 33
R 3/4"	G 1/4"	Edelstahl	333 31 36 32
R 3/4"	G 3/8"	Edelstahl	333 31 36 33
R 3/4"	G 1/2"	Edelstahl	333 31 36 34
R 1"	G 1/4"	Edelstahl	333 31 37 32
R 1"	G 3/8"	Edelstahl	333 31 37 33
R 1"	G 1/2"	Edelstahl	333 31 37 34
R 1"	G 3/4"	Edelstahl	333 31 37 36
R 1 1/4"	G 1/2"	Edelstahl	333 31 38 34
R 1 1/4"	G 3/4"	Edelstahl	333 31 38 36
R 1 1/4"	G 1"	Edelstahl	333 31 38 37
R 1 1/2"	G 1/2"	Edelstahl	333 31 39 34
R 1 1/2"	G 3/4"	Edelstahl	333 31 39 36
R 1 1/2"	G 1"	Edelstahl	333 31 39 37
R 1 1/2"	G 1 1/4"	Edelstahl	333 31 39 38
R 2"	G 1"	Edelstahl	333 31 40 37
R 2"	G 1 1/4"	Edelstahl	333 31 40 38
R 2"	G 1 1/2"	Edelstahl	333 31 40 39
R 2 1/2"	G 1 1/4"	Edelstahl	333 31 41 38
R 2 1/2"	G 1 1/2"	Edelstahl	333 31 41 39
R 2 1/2"	G 2"	Edelstahl	333 31 41 40
R 3"	G 2"	Edelstahl	333 31 42 40
R 3"	G 2 1/2"	Edelstahl	333 31 42 41
R 4"	G 2"	Edelstahl	333 31 43 40
R 4"	G 2 1/2"	Edelstahl	333 31 43 41



Doppelnippel

double connector



Gewinde 1 thread 1	Gewinde 2 thread 2	Material material	Art.-Nr.
G 1/4"	G 1/8"	Edelstahl	333 32 32 31
G 3/8"	G 1/8"	Edelstahl	333 32 33 31
G 3/8"	G 1/4"	Edelstahl	333 32 33 32
G 1/2"	G 1/8"	Edelstahl	333 32 34 31
G 1/2"	G 1/4"	Edelstahl	333 32 34 32
G 1/2"	G 3/8"	Edelstahl	333 32 34 33
G 3/4"	G 1/4"	Edelstahl	333 32 36 32
G 3/4"	G 3/8"	Edelstahl	333 32 36 33
G 3/4"	G 1/2"	Edelstahl	333 32 36 34
G 1"	G 1/4"	Edelstahl	333 32 37 32
G 1"	G 3/8"	Edelstahl	333 32 37 33
G 1"	G 1/2"	Edelstahl	333 32 37 34
G 1 1/4"	G 1/2"	Edelstahl	333 32 38 34
G 1 1/4"	G 3/4"	Edelstahl	333 32 38 36
G 1 1/4"	G 1"	Edelstahl	333 32 38 37
G 1 1/2"	G 1/2"	Edelstahl	333 32 39 34
G 1 1/2"	G 3/4"	Edelstahl	333 32 39 36
G 1 1/2"	G 1"	Edelstahl	333 32 39 37
G 1 1/2"	G 1 1/4"	Edelstahl	333 32 39 38
G 2"	G 1"	Edelstahl	333 32 40 37
G 2"	G 1 1/4"	Edelstahl	333 32 40 38
G 2"	G 1 1/2"	Edelstahl	333 32 40 39
G 2 1/2"	G 1 1/4"	Edelstahl	333 32 41 38
G 2 1/2"	G 1 1/2"	Edelstahl	333 32 41 39
G 2 1/2"	G 2"	Edelstahl	333 32 41 40
G 3"	G 1 1/2"	Edelstahl	333 32 42 39
G 3"	G 2"	Edelstahl	333 32 42 40
G 3"	G 2 1/2"	Edelstahl	333 32 42 41
G 4"	G 2"	Edelstahl	333 32 43 40
G 4"	G 2 1/2"	Edelstahl	333 32 43 41

Tempergussverschraubungen

Malleable iron pipe fittings



1 Langer Innen-/Außengewinde Bogen 90°

1 male/female long sweep bends 90°



Innengewinde internal thread	Außengewinde external thread	Art.-Nr.
R 1/4"	G 1/4"	418 01 32 32
R 3/8"	G 3/8"	418 01 33 33
R 1/2"	G 1/2"	418 01 34 34
R 3/4"	G 3/4"	418 01 36 36
R 1"	G 1"	418 01 37 37
R 1 1/4"	G 1 1/4"	418 01 38 38
R 1 1/2"	G 1 1/2"	418 01 39 39
R 2"	G 2"	418 01 40 40
R 2 1/2"	G 2 1/2"	418 01 45 45
R 3"	G 3"	418 01 50 50
R 4"	G 4"	418 01 55 55

2 Langer Innengewinde Bogen 90°

2 female long sweep bends 90°



Gewinde thread	Art.-Nr.
R 1/4"	418 02 32 32
R 3/8"	418 02 33 33
R 1/2"	418 02 34 34
R 3/4"	418 02 36 36
R 1"	418 02 37 37
R 1 1/4"	418 02 38 38
R 1 1/2"	418 02 39 39
R 2"	418 02 40 40
R 2 1/2"	418 02 45 45
R 3"	418 02 50 50
R 4"	418 02 55 55

40 Langer Innen-/Außengewinde Bogen 45°

40 male/female long sweep bends 45°



Innengewinde internal thread	Außengewinde external thread	Art.-Nr.
R 1/4"	G 1/4"	418 40 32 32
R 3/8"	G 3/8"	418 40 33 33
R 1/2"	G 1/2"	418 40 34 34
R 3/4"	G 3/4"	418 40 36 36
R 1"	G 1"	418 40 37 37
R 1 1/4"	G 1 1/4"	418 40 38 38
R 1 1/2"	G 1 1/2"	418 40 39 39
R 2"	G 2"	418 40 40 40
R 2 1/2"	G 2 1/2"	418 40 45 45
R 3"	G 3"	418 40 50 50
R 4"	G 4"	418 40 55 55

41 Innengewinde Bogen 45°

41 female long sweep bends 45°

Gewinde thread	Art.-Nr.
R 1/4"	418 41 32 32
R 3/8"	418 41 33 33
R 1/2"	418 41 34 34
R 3/4"	418 41 36 36
R 1"	418 41 37 37
R 1 1/4"	418 41 38 38
R 1 1/2"	418 41 39 39
R 2"	418 41 40 40
R 2 1/2"	418 41 45 45
R 3"	418 41 50 50



90 kurzer Innengewinde Bogen 90°

90 female short elbows 90°

Gewinde thread	Art.-Nr.
R 1/8"	418 90 31 31
R 1/4"	418 90 32 32
R 3/8"	418 90 33 33
R 1/2"	418 90 34 34
R 3/4"	418 90 36 36
R 1"	418 90 37 37
R 1 1/4"	418 90 38 38
R 1 1/2"	418 90 39 39
R 2"	418 90 40 40
R 2 1/2"	418 90 45 45
R 3"	418 90 50 50
R 4"	418 90 55 55



92 kurzer Innen-/Außengewinde Winkel 90°

92 female/male short elbows 90°

Innengewinde internal thread	Außengewinde external thread	Art.-Nr.
R 1/4"	G 1/4"	418 92 32 32
R 3/8"	G 3/8"	418 92 33 33
R 1/2"	G 1/2"	418 92 34 34
R 3/4"	G 3/4"	418 92 36 36
R 1"	G 1"	418 92 37 37
R 1 1/4"	G 1 1/4"	418 92 38 38
R 1 1/2"	G 1 1/2"	418 92 39 39
R 2"	G 2"	418 92 40 40
R 2 1/2"	G 2 1/2"	418 92 45 45
R 3"	G 3"	418 92 50 50
R 4"	G 4"	418 92 55 55



96 Innengewinde Winkelverschraubung kegelig

96 female angle screw unions tapered



Gewinde thread	Art.-Nr.
R 3/8"	418 96 33 33
R 1/2"	418 96 34 34
R 3/4"	418 96 36 36
R 1"	418 96 37 37
R 1 1/4"	418 96 38 38
R 1 1/2"	418 96 39 39
R 2"	418 96 40 40

98 Innen-/Außengewinde Winkelverschraubung kegelig

98 male/female angle screw unions tapered



Innengewinde internal thread	Außengewinde external thread	Art.-Nr.
R 1/4"	R 1/4"	418 98 32 32
R 3/8"	R 3/8"	418 98 33 33
R 1/2"	R 1/2"	418 98 34 34
R 3/4"	R 3/4"	418 98 36 36
R 1"	R 1"	418 98 37 37
R 1 1/4"	R 1 1/4"	418 98 38 38
R 1 1/2"	R 1 1/2"	418 98 39 39
R 2"	R 2"	418 98 40 40

220 Innengewinde Y-Stücke

220 female thread Y-unions



Gewinde thread	Art.-Nr.
R 1/2"	418 22 34 34
R 3/4"	418 22 36 36
R 1"	418 22 37 37

130 Innengewinde T-Stücke

130 female thread T-unions



Gewinde thread	Art.-Nr.
R 1/4"	418 13 32 32
R 3/8"	418 13 33 33
R 1/2"	418 13 34 34
R 3/4"	418 13 36 36
R 1"	418 13 37 37
R 1 1/4"	418 13 38 38
R 1 1/2"	418 13 39 39
R 2"	418 13 40 40
R 2 1/2"	418 13 45 45
R 3"	418 13 50 50
R 4"	418 13 55 55

180 Kreuzstücke Innengewinde

180 cross pieces female thread

Gewinde thread	Art.-Nr.
R 3/8"	418 18 33 33
R 1/2"	418 18 34 34
R 3/4"	418 18 36 36
R 1"	418 18 37 37
R 1 1/4"	418 18 38 38
R 1 1/2"	418 18 39 39
R 2"	418 18 40 40
R 2 1/2"	418 18 45 45
R 3"	418 18 50 50
R 4"	418 18 55 55



240 Muffen reduziert Innengewinde/Innengewinde

240 reduced sockets female thread/female thread

Gewinde 1 thread 1	Gewinde 2 thread 2	Art.-Nr.
R 1/4"	R 1/8"	418 24 32 31
R 3/8"	R 1/4"	418 24 33 32
R 1/2"	R 1/4"	418 24 34 32
R 1/2"	R 3/8"	418 24 34 33
R 3/4"	R 1/4"	418 24 36 32
R 3/4"	R 3/8"	418 24 36 33
R 3/4"	R 1/2"	418 24 36 34
R 1"	R 3/8"	418 24 37 33
R 1"	R 1/2"	418 24 37 34
R 1"	R 3/4"	418 24 37 36
R 1 1/4"	R 3/8"	418 24 38 33
R 1 1/4"	R 1/2"	418 24 38 34
R 1 1/4"	R 3/4"	418 24 38 36
R 1 1/4"	R 1"	418 24 38 37
R 1 1/2"	R 1/2"	418 24 39 34
R 1 1/2"	R 3/4"	418 24 39 36
R 1 1/2"	R 1"	418 24 39 37
R 1 1/2"	R 1 1/4"	418 24 39 38
R 2"	R 1/2"	418 24 40 34
R 2"	R 3/4"	418 24 40 36
R 2"	R 1"	418 24 40 37
R 2"	R 1 1/4"	418 24 40 38
R 2"	R 1 1/2"	418 24 40 39
R 2 1/2"	R 1"	418 24 45 37
R 2 1/2"	R 1 1/4"	418 24 45 38
R 2 1/2"	R 1 1/2"	418 24 45 39
R 2 1/2"	R 2"	418 24 45 40
R 3"	R 1"	418 24 50 37
R 3"	R 1 1/4"	418 24 50 38
R 3"	R 1 1/2"	418 24 50 39
R 3"	R 2"	418 24 50 40
R 3"	R 2 1/2"	418 24 50 45
R 4"	R 2"	418 24 55 40
R 4"	R 2 1/2"	418 24 55 45
R 4"	R 3"	418 24 55 50



241 Nippel reduziert Außengewinde/Innengewinde

241 reduced nipples female thread/female thread



Außengewinde external thread	Innengewinde internal thread	Art.-Nr.
G 1/4"	R 1/8"	418 25 32 31
G 3/8"	R 1/8"	418 25 33 31
G 3/8"	R 1/4"	418 25 33 32
G 1/2"	R 1/8"	418 25 34 31
G 1/2"	R 1/4"	418 25 34 32
G 1/2"	R 3/8"	418 25 34 33
G 3/4"	R 1/4"	418 25 36 32
G 3/4"	R 3/8"	418 25 36 33
G 3/4"	R 1/2"	418 25 36 34
G 1"	R 3/8"	418 25 37 33
G 1"	R 1/2"	418 25 37 34
G 1"	R 3/4"	418 25 37 36
G 1 1/4"	R 3/8"	418 25 38 33
G 1 1/4"	R 1/2"	418 25 38 34
G 1 1/4"	R 3/4"	418 25 38 36
G 1 1/4"	R 1"	418 25 38 37
G 1 1/2"	R 1/2"	418 25 39 34
G 1 1/2"	R 3/4"	418 25 39 36
G 1 1/2"	R 1"	418 25 39 37
G 1 1/2"	R 1 1/4"	418 25 39 38
G 2"	R 1/2"	418 25 40 34
G 2"	R 3/4"	418 25 40 36
G 2"	R 1"	418 25 40 37
G 2"	R 1 1/4"	418 25 40 38
G 2"	R 1 1/2"	418 25 40 39
G 2 1/2"	R 1"	418 25 45 37
G 2 1/2"	R 1 1/4"	418 25 45 38
G 2 1/2"	R 1 1/2"	418 25 45 39
G 2 1/2"	R 2"	418 25 45 40
G 3"	R 1"	418 25 50 37
G 3"	R 1 1/4"	418 25 50 38
G 3"	R 1 1/2"	418 25 50 39
G 3"	R 2"	418 25 50 40
G 3"	R 2 1/2"	418 25 50 45
G 4"	R 1 1/2"	418 25 55 39
G 4"	R 2"	418 25 55 40
G 4"	R 2 1/2"	418 25 55 45
G 4"	R 3"	418 25 55 50

245 Doppelnippel reduziert Außengewinden/Außengewinde

245 reduced double nipples male thread/male thread

Gewinde 1 thread 1	Gewinde 2 thread 2	Art.-Nr.
G 1/4"	G 1/8"	418 26 32 31
G 3/8"	G 1/8"	418 26 33 31
G 3/8"	G 1/4"	418 26 33 32
G 1/2"	G 1/4"	418 26 34 32
G 1/2"	G 3/8"	418 26 34 33
G 3/4"	G 3/8"	418 26 36 33
G 3/4"	G 1/2"	418 26 36 34
G 1"	G 3/8"	418 26 37 33
G 1"	G 1/2"	418 26 37 34
G 1"	G 3/4"	418 26 37 36
G 1 1/4"	G 1/2"	418 26 38 34
G 1 1/4"	G 3/4"	418 26 38 36
G 1 1/4"	G 1"	418 26 38 37
G 1 1/2"	G 3/4"	418 26 39 36
G 1 1/2"	G 1"	418 26 39 37
G 1 1/2"	G 1 1/4"	418 26 39 38
G 2"	G 3/4"	418 26 40 36
G 2"	G 1"	418 26 40 37
G 2"	G 1 1/4"	418 26 40 38
G 2"	G 1 1/2"	418 26 40 39
G 2 1/2"	G 1"	418 26 45 37
G 2 1/2"	G 1 1/4"	418 26 45 38
G 2 1/2"	G 1 1/2"	418 26 45 39
G 2 1/2"	G 2"	418 26 45 40
G 3"	G 2"	418 26 50 40
G 3"	G 2 1/2"	418 26 50 45



246 Muffen reduziert Außengewinde/Innengewinde

246 reduced sockets male thread/female thread

Innengewinde internal thread	Außengewinde external thread	Art.-Nr.
R 3/8"	G 1/4"	418 21 33 32
R 1/2"	G 1/4"	418 21 34 32
R 1/2"	G 3/8"	418 21 34 33
R 3/4"	G 3/8"	418 21 36 33
R 3/4"	G 1/2"	418 21 36 34
R 1"	G 1/2"	418 21 37 34
R 1"	G 3/4"	418 21 37 36
R 1 1/4"	G 3/4"	418 21 38 36
R 1 1/4"	G 1"	418 21 38 37
R 1 1/2"	G 1"	418 21 39 37
R 1 1/2"	G 1 1/4"	418 21 39 38
R 2"	G 1 1/4"	418 21 40 38
R 2"	G 1 1/2"	418 21 40 39



270 Innengewinde Muffen

270 sockets female thread



Gewinde thread	Art.-Nr.
R 1/4"	418 27 32 32
R 3/8"	418 27 33 33
R 1/2"	418 27 34 34
R 3/4"	418 27 36 36
R 1"	418 27 37 37
R 1 1/4"	418 27 38 38
R 1 1/2"	418 27 39 39
R 2"	418 27 40 40
R 2 1/2"	418 27 45 45
R 3"	418 27 50 50
R 4"	418 27 55 55

280 Außengewinde Doppelnippel

280 double nipples male thread



Gewinde thread	Art.-Nr.
G 1/8"	418 28 31 31
G 1/4"	418 28 32 32
G 3/8"	418 28 33 33
G 1/2"	418 28 34 34
G 3/4"	418 28 36 36
G 1"	418 28 37 37
G 1 1/4"	418 28 38 38
G 1 1/2"	418 28 39 39
G 2"	418 28 40 40
G 2 1/2"	418 28 45 45
G 3"	418 28 50 50
G 4"	418 28 55 55

290 Stopfen mit Rand

290 beaded plugs

Gewinde thread	Art.-Nr.
G 1/8"	418 36 31 31
G 1/4"	418 36 32 32
G 3/8"	418 36 33 33
G 1/2"	418 36 34 34
G 3/4"	418 36 36 36
G 1"	418 36 37 37
G 1 1/4"	418 36 38 38
G 1 1/2"	418 36 39 39
G 2"	418 36 40 40
G 2 1/2"	418 36 45 45
G 3"	418 36 50 50
G 4"	418 36 55 55



291 Stopfen ohne Rand

291 plain plugs

Gewinde thread	Art.-Nr.
G 1/4"	418 29 32 32
G 3/8"	418 29 33 33
G 1/2"	418 29 34 34
G 3/4"	418 29 36 36
G 1"	418 29 37 37
G 1 1/4"	418 29 38 38
G 1 1/2"	418 29 39 39
G 2"	418 29 40 40
G 2 1/2"	418 29 45 45
G 3"	418 29 50 50
G 4"	418 29 55 55



300 Sechskantkappen mit Innengewinde

300 hexagonal caps with female thread



Gewinde thread	Art.-Nr.
R 1/8"	418 30 31 31
R 1/4"	418 30 32 32
R 3/8"	418 30 33 33
R 1/2"	418 30 34 34
R 3/4"	418 30 36 36
R 1"	418 30 37 37
R 1 1/4"	418 30 38 38
R 1 1/2"	418 30 39 39
R 2"	418 30 40 40
R 2 1/2"	418 30 45 45
R 3"	418 30 50 50
R 4"	418 30 55 55

340 Verschraubungen mit kegeligem Innengewinde

340 unions with female thread



Gewinde thread	Art.-Nr.
R 3/8"	418 35 33 33
R 1/2"	418 35 34 34
R 3/4"	418 35 36 36
R 1"	418 35 37 37
R 1 1/4"	418 35 38 38
R 1 1/2"	418 35 39 39
R 2"	418 35 40 40
R 2 1/2"	418 35 45 45
R 3"	418 35 50 50
R 4"	418 35 55 55

341 Verschraubungen mit kegeligem Innengewinde/Außengewinde

341 unions with female thread/male thread



Innengewinde internal thread	Außengewinde external thread	Art.-Nr.
R 3/8"	R 3/8"	418 34 33 33
R 1/2"	R 1/2"	418 34 34 34
R 3/4"	R 3/4"	418 34 36 36
R 1"	R 1"	418 34 37 37
R 1 1/4"	R 1 1/4"	418 34 38 38
R 1 1/2"	R 1 1/2"	418 34 39 39
R 2"	R 2"	418 34 40 40
R 2 1/2"	R 2 1/2"	418 34 45 45
R 3"	R 3"	418 34 50 50
R 4"	R 4"	418 34 55 55

Rohrverlängerungen Außengewinde

barrel nipple male thread



Gewinde thread	Länge length mm	Art.-Nr.
G 1/4"	60	418 95 32 06
G 1/4"	80	418 95 32 08
G 1/4"	100	418 95 32 10
G 1/4"	120	418 95 32 12
G 1/4"	150	418 95 32 15
G 1/4"	180	418 95 32 18
G 1/4"	200	418 95 32 20
G 1/4"	250	418 95 32 25
G 1/4"	300	418 95 32 30
G 3/8"	50	418 95 33 05
G 3/8"	60	418 95 33 06
G 3/8"	80	418 95 33 08
G 3/8"	100	418 95 33 10
G 3/8"	120	418 95 33 12
G 3/8"	150	418 95 33 15
G 3/8"	180	418 95 33 18
G 3/8"	200	418 95 33 20
G 3/8"	250	418 95 33 25
G 3/8"	300	418 95 33 30
G 3/8"	500	418 95 33 50
G 3/8"	1000	418 95 33 90
G 1/2"	50	418 95 34 05
G 1/2"	60	418 95 34 06
G 1/2"	80	418 95 34 08
G 1/2"	100	418 95 34 10
G 1/2"	120	418 95 34 12
G 1/2"	150	418 95 34 15
G 1/2"	180	418 95 34 18
G 1/2"	200	418 95 34 20
G 1/2"	250	418 95 34 25
G 1/2"	300	418 95 34 30
G 1/2"	400	418 95 34 40
G 1/2"	500	418 95 34 50
G 1/2"	60	418 95 34 60
G 1/2"	800	418 95 34 80
G 1/2"	1000	418 95 34 90
G 3/4"	50	418 95 36 05
G 3/4"	60	418 95 36 06
G 3/4"	80	418 95 36 08
G 3/4"	100	418 95 36 10
G 3/4"	120	418 95 36 12
G 3/4"	150	418 95 36 15
G 3/4"	180	418 95 36 18
G 3/4"	200	418 95 36 20
G 3/4"	250	418 95 36 25
G 3/4"	300	418 95 36 30
G 3/4"	400	418 95 36 40
G 3/4"	500	418 95 36 50
G 3/4"	600	418 95 36 60
G 3/4"	800	418 95 36 80
G 3/4"	1000	418 95 36 90

Gewinde thread	Länge length mm	Art.-Nr.
G 1"	50	418 95 37 05
G 1"	60	418 95 37 06
G 1"	80	418 95 37 08
G 1"	100	418 95 37 10
G 1"	120	418 95 37 12
G 1"	150	418 95 37 15
G 1"	180	418 95 37 18
G 1"	200	418 95 37 20
G 1"	250	418 95 37 25
G 1"	300	418 95 37 30
G 1"	400	418 95 37 40
G 1"	500	418 95 37 50
G 1"	600	418 95 37 60
G 1"	800	418 95 37 80
G 1"	1000	418 95 37 90
G 1 1/4"	50	418 95 38 05
G 1 1/4"	60	418 95 38 06
G 1 1/4"	80	418 95 38 08
G 1 1/4"	100	418 95 38 10
G 1 1/4"	120	418 95 38 12
G 1 1/4"	150	418 95 38 15
G 1 1/4"	180	418 95 38 18
G 1 1/4"	200	418 95 38 20
G 1 1/4"	250	418 95 38 25
G 1 1/4"	300	418 95 38 30
G 1 1/4"	400	418 95 38 40
G 1 1/4"	500	418 95 38 50
G 1 1/4"	600	418 95 38 60
G 1 1/4"	800	418 95 38 80
G 1 1/4"	1000	418 95 38 90
G 1 1/2"	50	418 95 39 05
G 1 1/2"	60	418 95 39 06
G 1 1/2"	80	418 95 39 08
G 1 1/2"	100	418 95 39 10
G 1 1/2"	120	418 95 39 12
G 1 1/2"	150	418 95 39 15
G 1 1/2"	180	418 95 39 18
G 1 1/2"	200	418 95 39 20
G 1 1/2"	250	418 95 39 25
G 1 1/2"	300	418 95 39 30
G 1 1/2"	400	418 95 39 40
G 1 1/2"	500	418 95 39 50
G 1 1/2"	600	418 95 39 60
G 1 1/2"	800	418 95 39 80
G 1 1/2"	1000	418 95 39 90

Gewinde thread	Länge length mm	Art.-Nr.
G 2"	50	418 95 40 05
G 2"	60	418 95 40 06
G 2"	80	418 95 40 08
G 2"	100	418 95 40 10
G 2"	120	418 95 40 12
G 2"	150	418 95 40 15
G 2"	180	418 95 40 18
G 2"	200	418 95 40 20
G 2"	250	418 95 40 25
G 2"	300	418 95 40 30
G 2"	400	418 95 40 40
G 2"	500	418 95 40 50
G 2"	600	418 95 40 60
G 2"	800	418 95 40 80
G 2"	1000	418 95 40 90

Notizen/notes

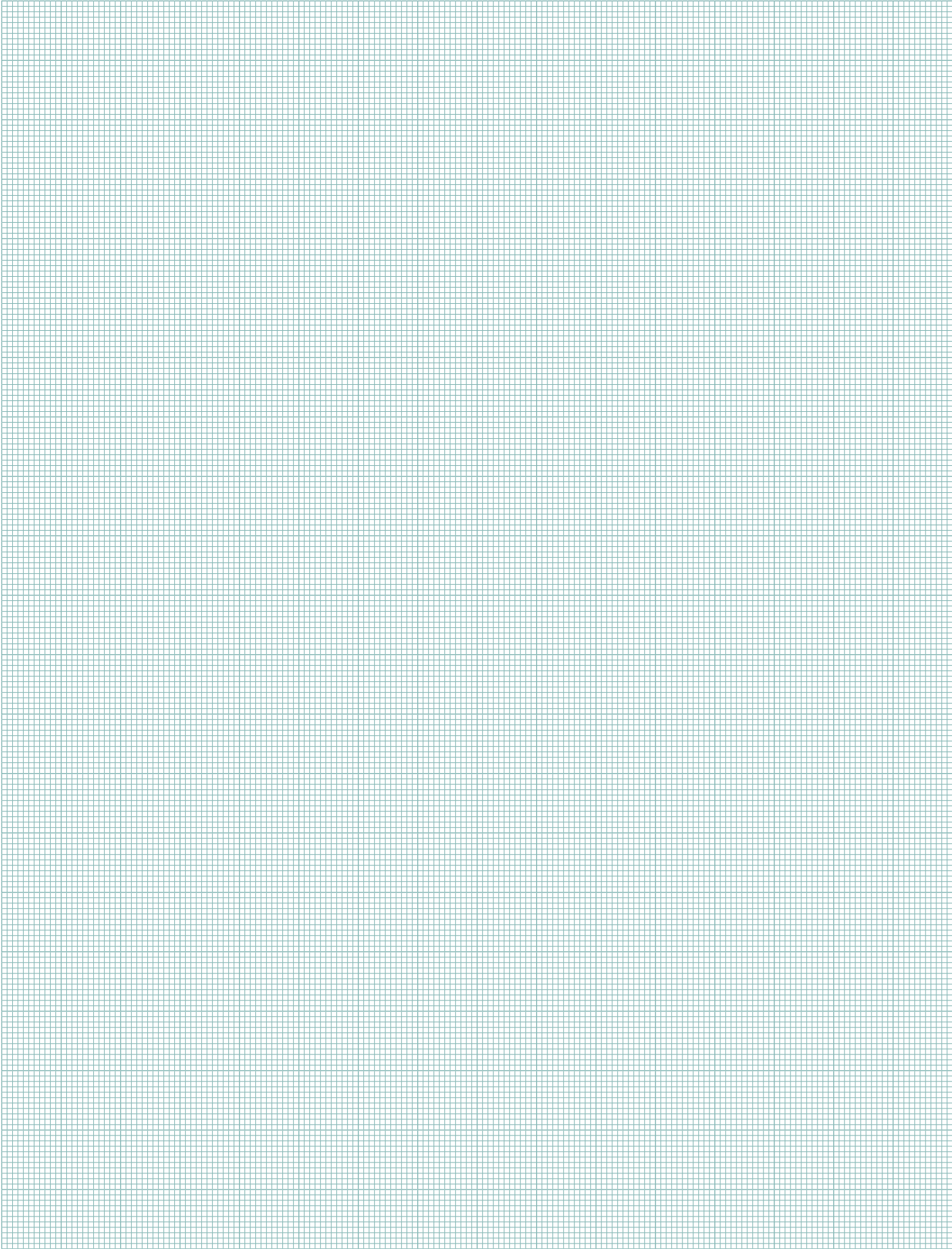

Notizen/notes

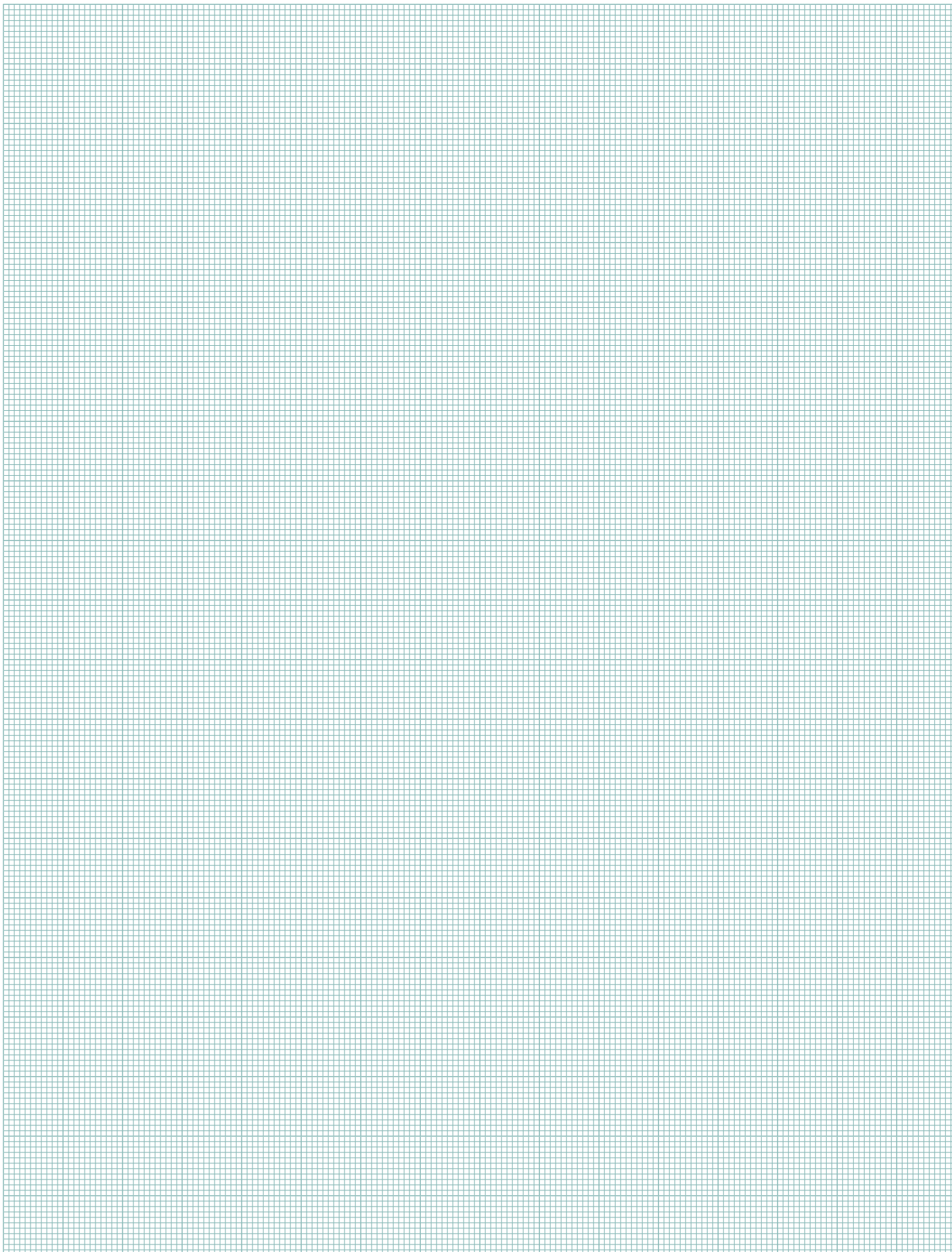

Notizen/notes

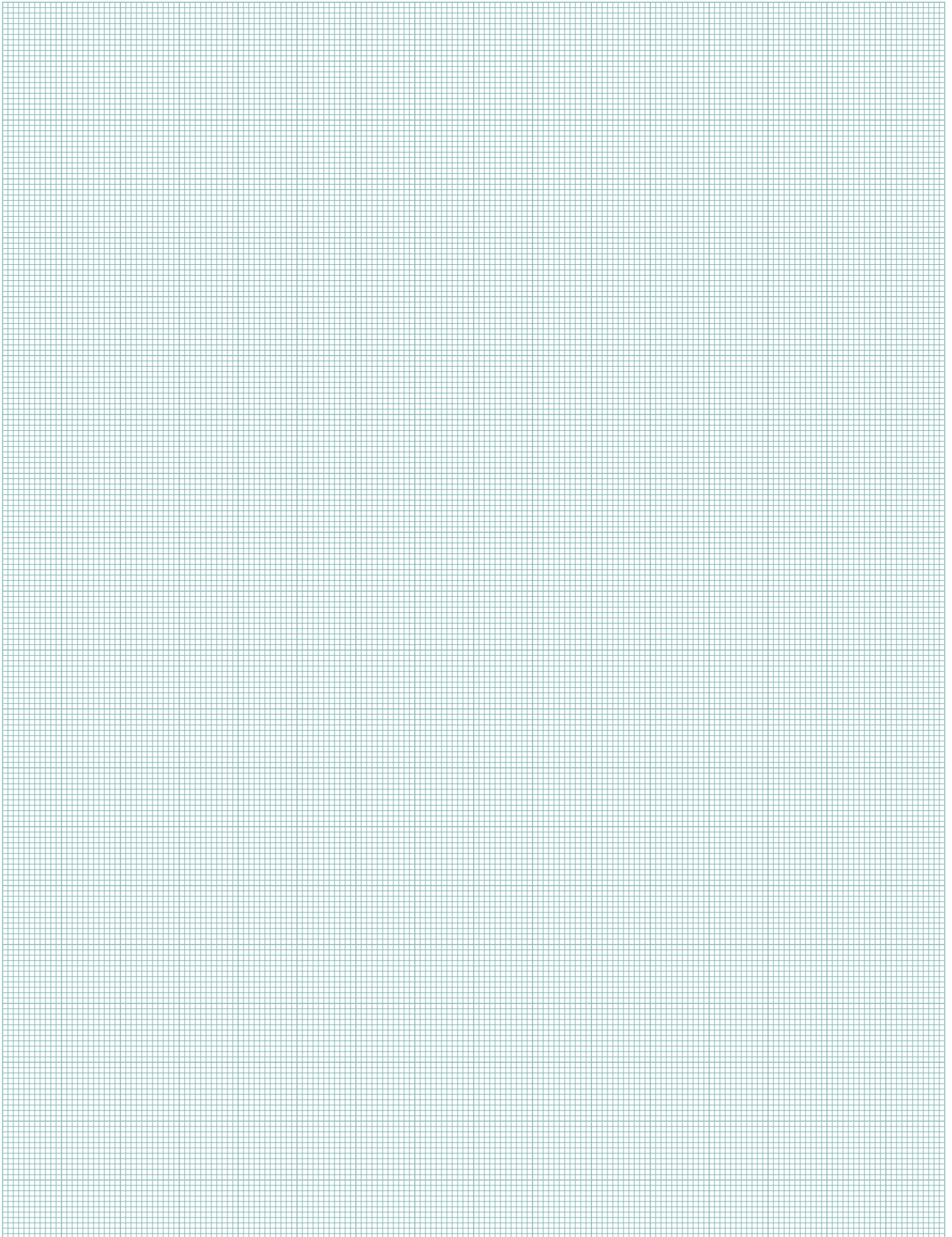

Notizen/notes

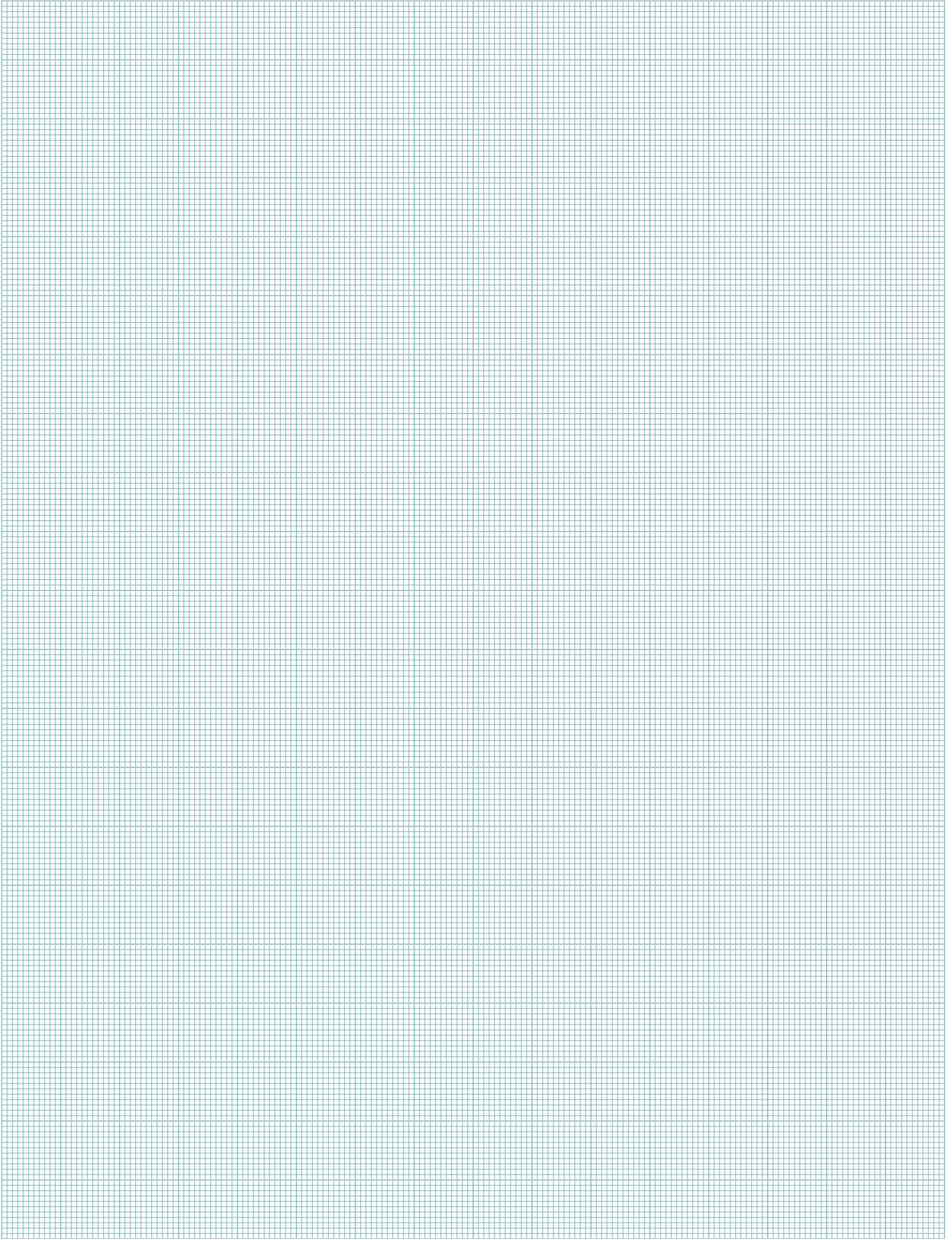

Notizen/notes

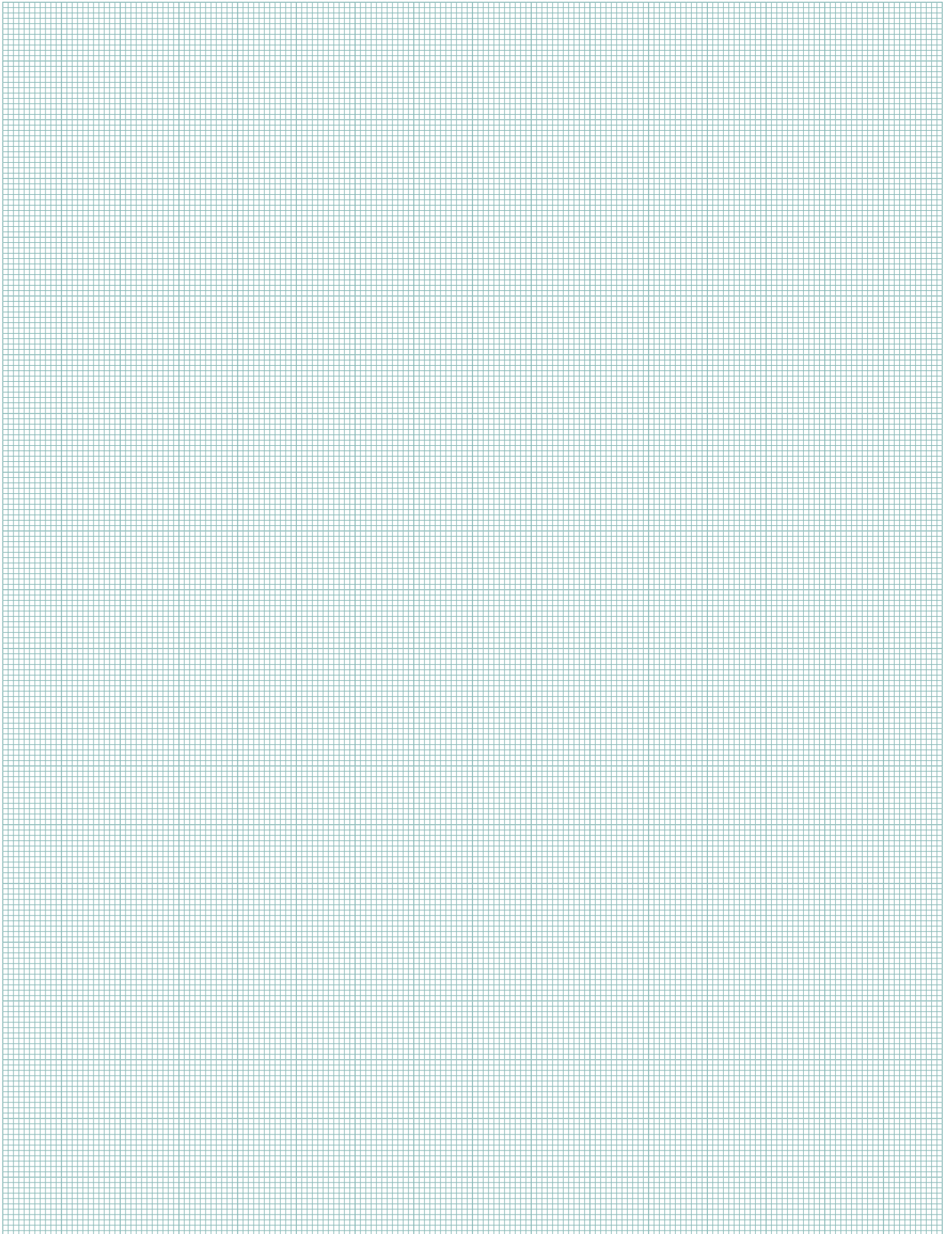

Notizen/notes

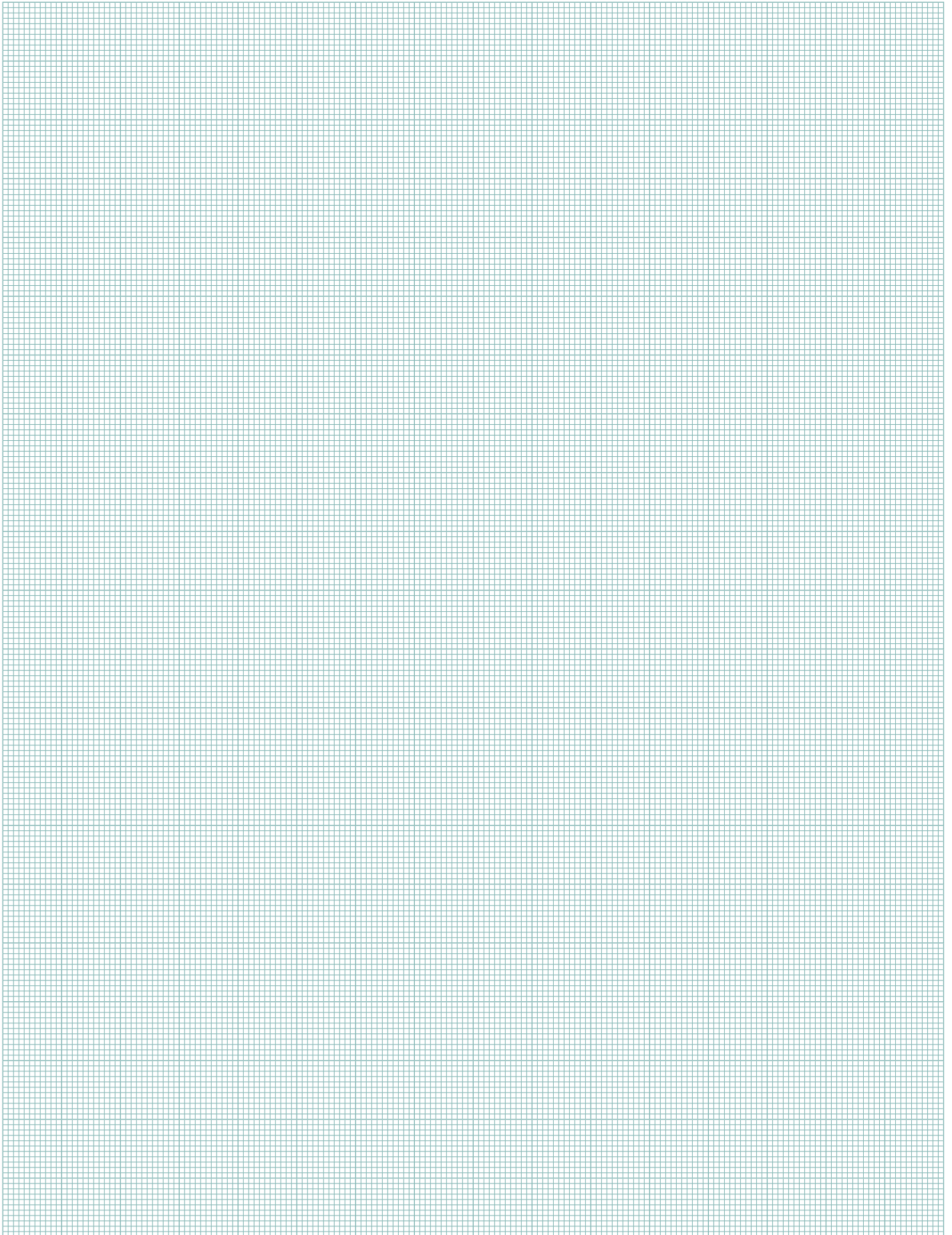

Notizen/notes

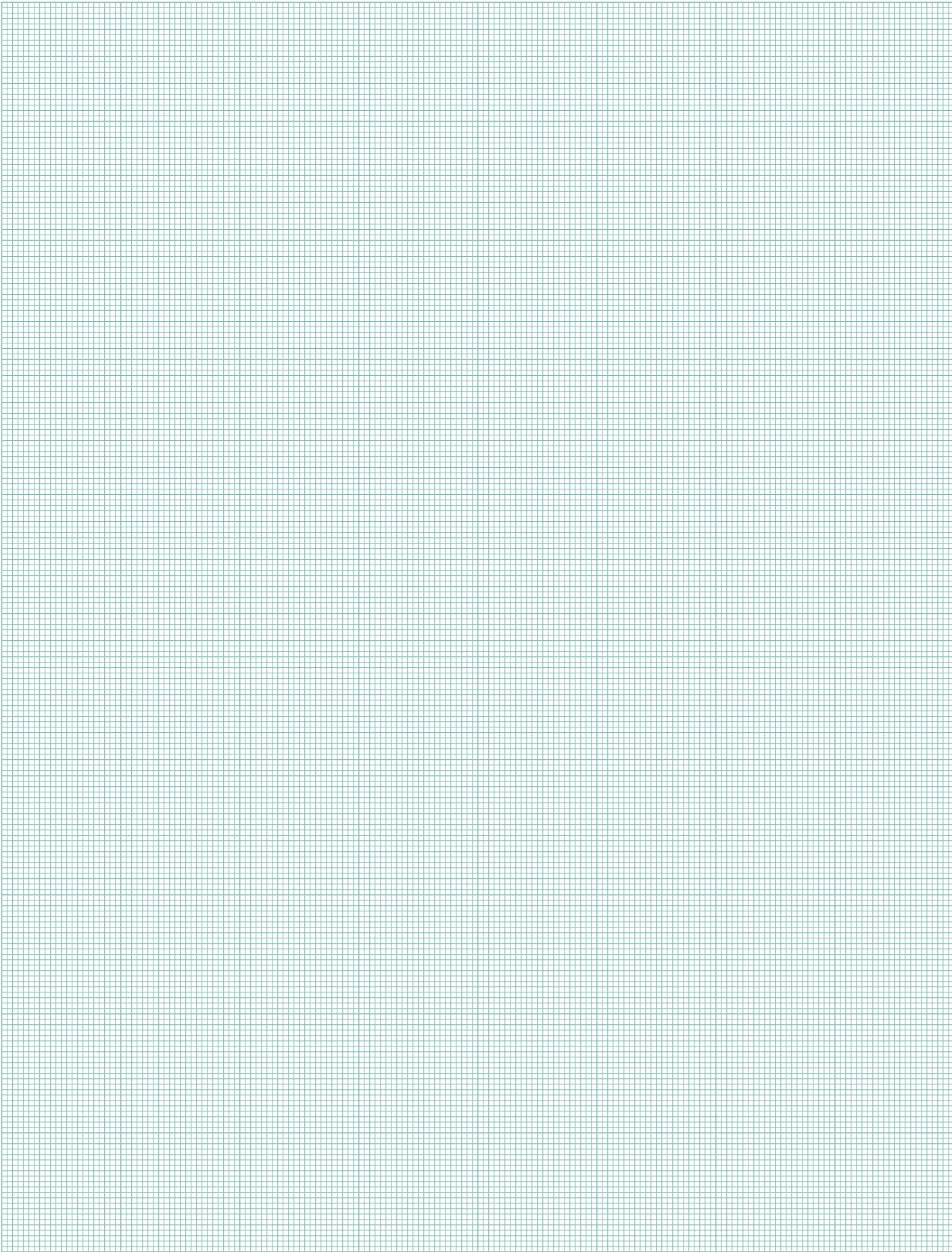

Notizen/notes

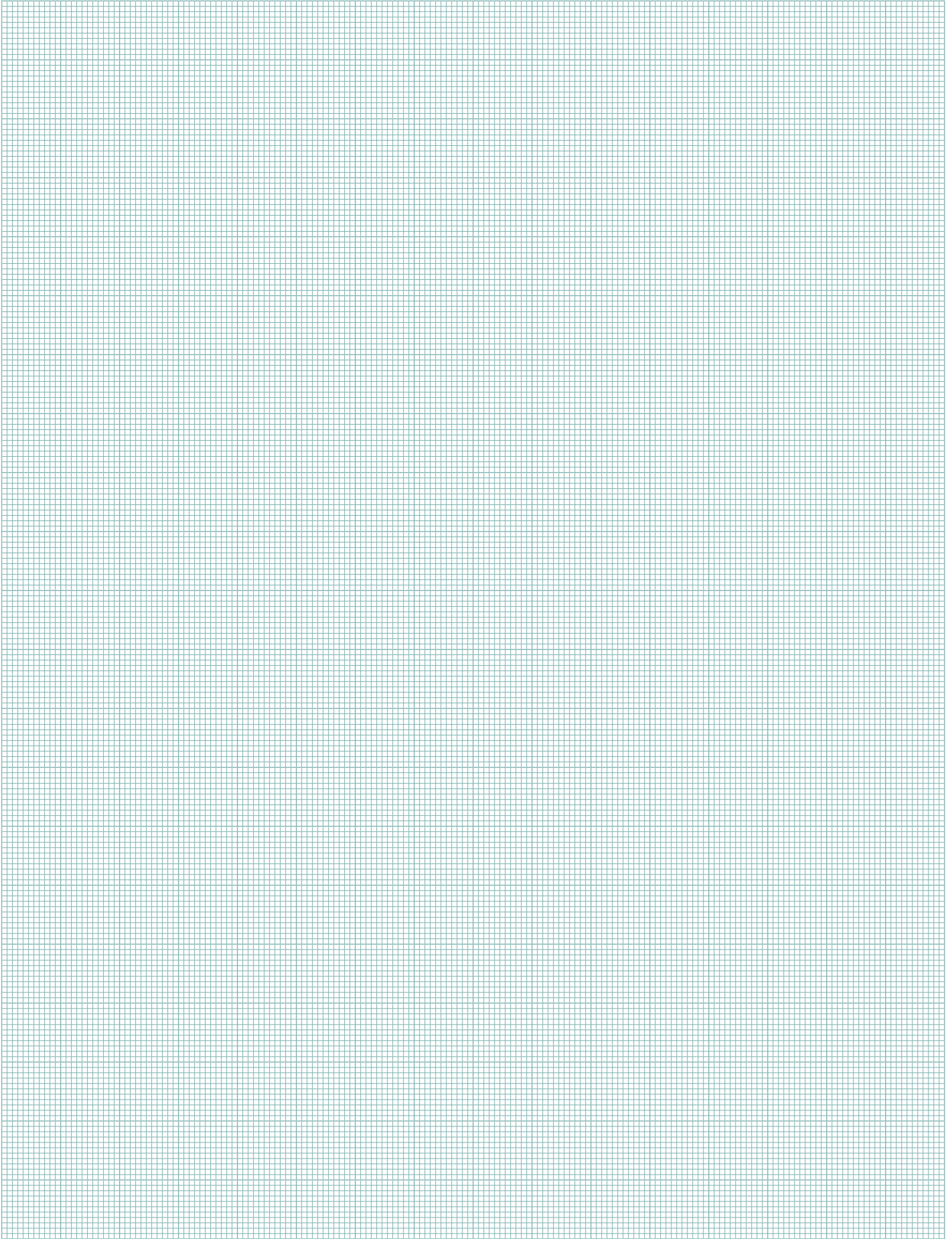

Notizen/notes

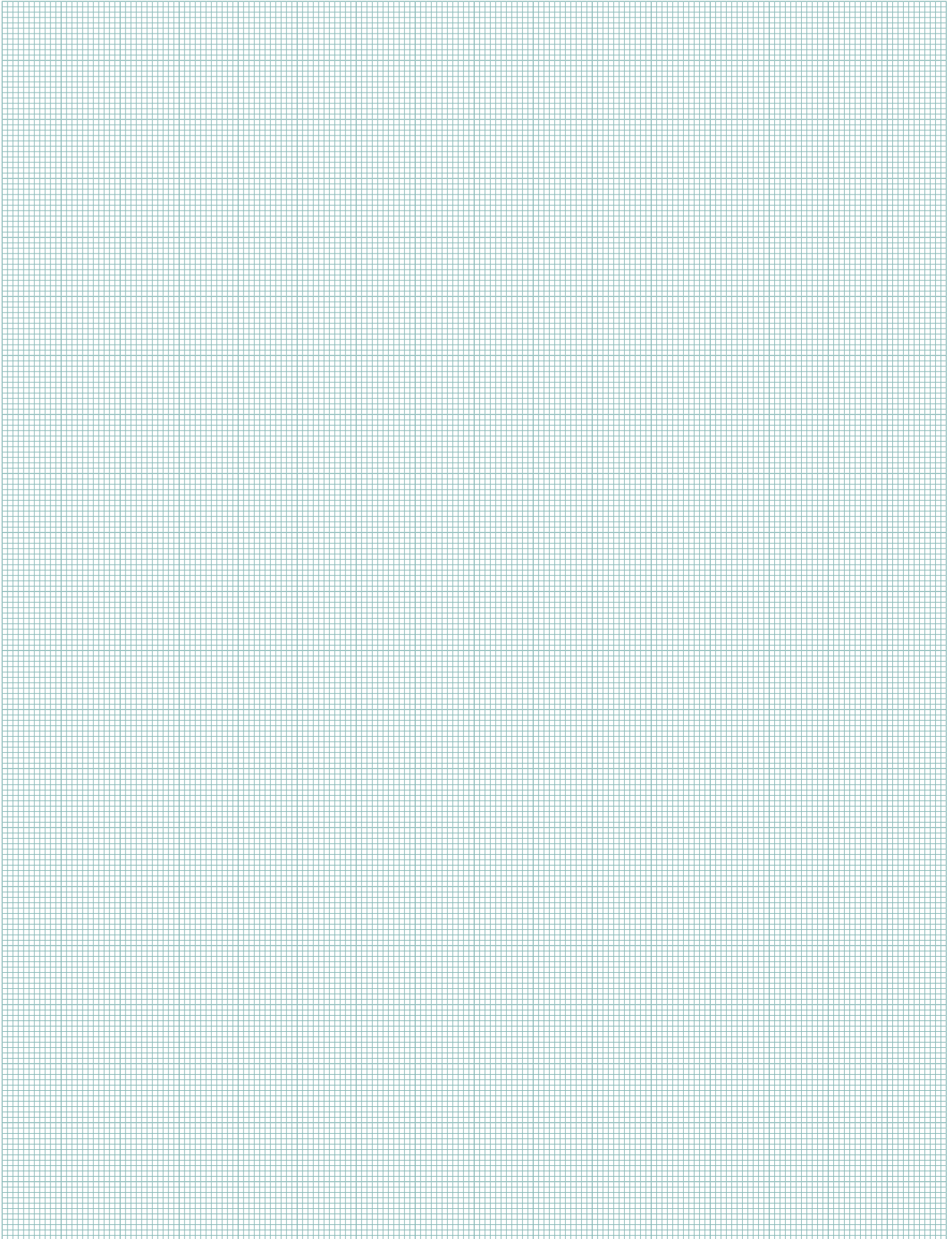

Notizen/notes

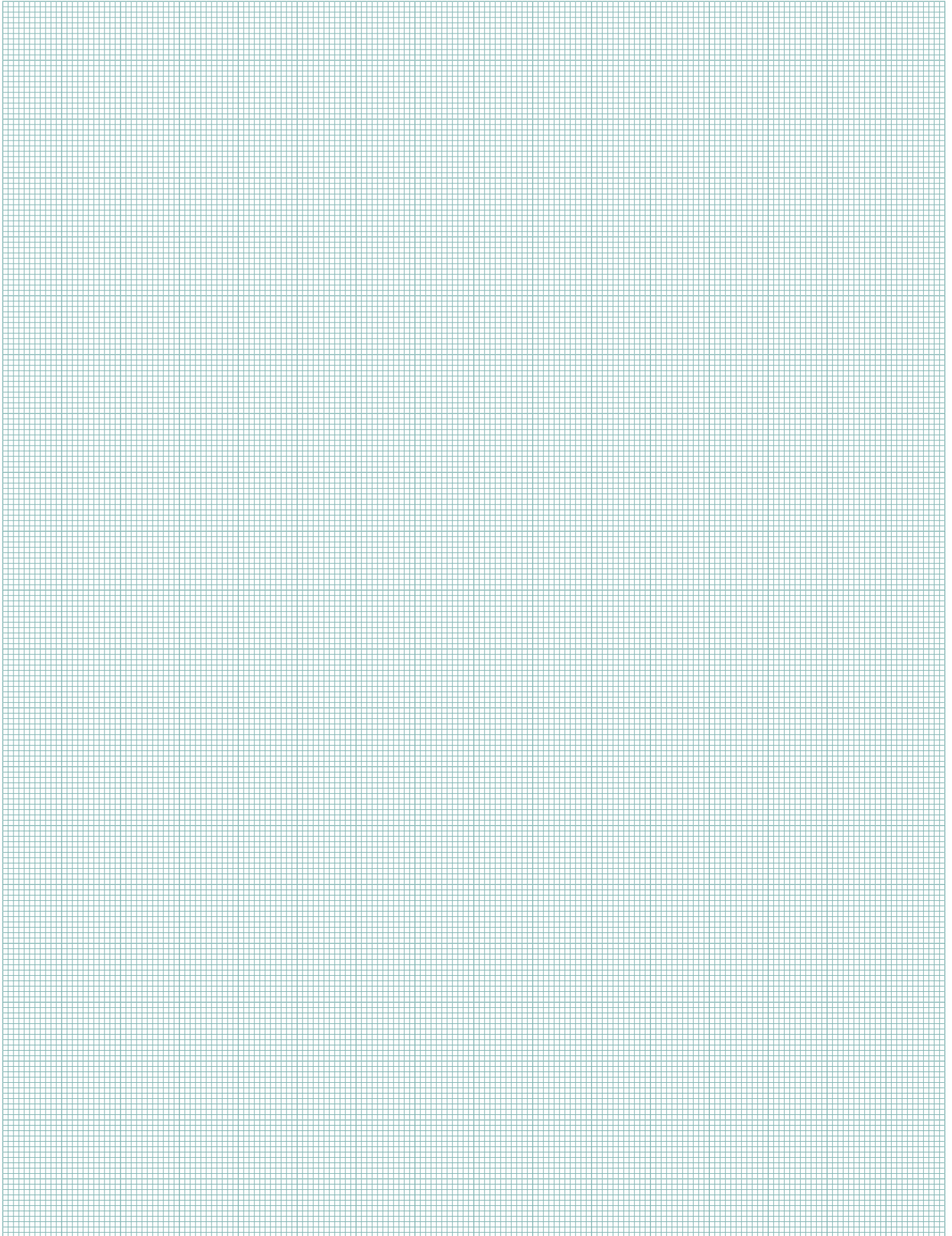



3-Wege-Kugelhähne	71	Einschraubtüllen	266
AF-Hochdruckschlauch	144	Ersatzpressbacken	81
Aluminium-Lötningel	194	Ersatzteile für Kältemittel-Pressen	203
Aluminium-Dichtringe	100	Fasshähne	158
Aluminium-Rohr	195	Fassungen	272, 273
Anschlussnippel	254	Federsplinte DIN 11024	225, 233
API Guillemin	279	Fettpressen	157
A-PL-Schlauch	31	Fettpressschläuche	155
Aquapal	44	Fiber-Dichtringe	100
Armaturen für O-Ring-Abdichtung	196, 197, 198, 199	Flachschmiernippel	154
Armaturen mit SAE-Außengewinde	195, 196, 199	FPM/ECO-Schlauch	27
A-Schlauch	19	Fußventile „Europa“	248
Aufschraubmuffen 90°	325	Gabelgelenkbolzen	182, 183
Aufschraubverschraubung	147	Gabelgelenke	181
Auslaufventile	240	Gabelköpfe	182
Außengewinde Polyamidrohrnippel	88	GBS-Schneckenwindeschellen	169
Außengewindetüllen	253	GCK-Schlauch	21, 28
AVA-Schlauch	20	GCNA-Schlauch	22
Bauer-Kupplungen	317, 318	GCWA-Schlauch	23
Befestigungsschellen	173	GCW-Schlauch	22
Befüllanschlüsse	159	gerade Verschraubungen	92, 96
Befüllzylinder	158	Gewindereduzierungen	68, 323, 327
Bohrhammer-Kugelhähne	245	Gewindeschutz	75, 76, 77
BSN/BSS-Befestigungsschellen	172, 173	Goldschlange	42
Cobra Handzangen	170	Guillemin	310 - 313
Cobra-Schlauschellen	170	Guillemin Adapter	312, 313
Codital-Verschraubungen	330 - 339	Guillemin Blindkupplungen	312
Dampf Trix 5000	45	Guillemin Dichtungen	314
Dampf Trix 6000	45	Halteschrauben	229
DAS Armaturen	302	HNBR-Schlauch	29
DBK-Schlauch	28	Hohlschrauben	64
Dichtkappen für Winkelgelenke	181	Hülsen	270, 271
Dichtkegel zum Auflöten	65	Kältemittelschlauch Typ 3055 - Barrier	194
Dichtungen	266, 278 191	Kältemittel-Schlauchpresse	202
Dichtungen NBR	225, 227, 233, 238	Kamlok Dichtungen	292
Dichtungen Perbunan	238	Kamlok Kappen DC	288
Dichtungen Silikon	225, 227, 233, 242	Kamlok Ketten	293
Doppelkegelringe	134, 134	Kamlok Mutterteile	283 - 285, 290, 291
Doppelkugelhähne	244	Kamlok Reperatur-Sets	293
Doppelnippel	328	Kamlok Sicherungssplinte	293
Doppelstecker - reduziert	265	Kamlok Stopfen DP	289
Doppelstutzen	66, 323, 324	Kamlok Varterteile	282, 286, 287, 290
Drehgelenke	155	Kegelringe	135
Drehgelenke 90°	136, 137	Kegeltüllen	252
Düsenrohre	156	Kennzeichnungsringe	151
Düsenrohr-Schnellkupplungen	158	Ketten für Verschlusskupplung	225
ECOLINE-Schlauch	28	Klauenkupplungen für Druckluft	222 - 228, 230, 232
Einfach-Kugelhähne	245, 246	Klauenkupplungen für Wasser	236, 237, 238, 241
Einschlag-Schmiernippel	150	Klauenschellen	259
Einschlag-Trichterschmiernippel	153	Klemmschalen	269, 270

Kniestücke	137	Presswerkzeug	80, 81
KR-Schlauch	25	PVC-Schlauch	32, 35
KRS-Schlauch	26	PVC-Spiralschlauch	36
KS-Schlauch	33		
Kugelpfannen	179, 180	Reduziermuffen	326
Kugelzapfen	180	Reduzierstutzen	67
Kupfer-Dichtringe	98, 99	Ringlötstücke	65
Kupfer-Dichtringe Zwilling	99	Ringnippel	60
Kupferrohr	35	Ringnippel für Polyamidrohr	88
Kupplungsmuffen	159	Ringschraubstutzen	61 - 63
Kupplungsstecker	159	Rohrbögen	52, 53, 61
Lactopal	39	Rohrnippel BE	53, 54
Lactopal L	40	Rohrverbinder	140, 141
Lötstutzen	66	Rohr-Verbindungsmuffen	136
		Rohrverschraubungen	134
Macon-Kupplungen	298, 299	RSGU 1.-Rohrschellen	171, 172
Messinghülsen	229	Rückschlagventile	148, 248
Mini-Kugelhähne	71		
Montagehebel SMS/Macon	320	Schalenverschraubungen	268, 269
Montagevorrichtung	81	Scheiben für Gabelgelenkbolzen	183
Mörtelkupplungen	262 - 265	Schiebekupplungen	155
KRV-Kupplungen	291, 301	Schlauchhülsen	50
Muffen	323, 325	Schlauchklemmen	258, 259
Muffen 90°	324, 325	Schlauchnippel	50, 51, 57 - 59
Muffen-Kugelhähne	72, 73	Schlauchringe für Messingdichtung	229
Muffenschieber	74	Schlauchstopper	158
Mundstücke	154 - 156	Schlauchverbinder	78 - 80, 255, 256
		Schlauchverbindungs-nippel	253
Nippel mit BSPP/BSPT-Gewinde	322	Schmiernippel DIN 71412	146, 147
Nippelblöcke mit T-Bohrung	141	Schmiernippel Schnellwechsler	156
Nockenhebel	266	Schmiernippel selbstschneidend	149
		Schmutzfänger	249
Ölablassschrauben mit Ventil	190	Schneidringe	56, 90
OLNS 1-Schlauch	24	Schott-Rohrverbinder	135
OLN-Schlauch	23	Schraubfassungen	144
O-Ringe, metrisch	102 - 104, 107 - 115, 120 - 127	Schraubkappen für Ablassventile	191
O-Ringe, zöllig	105 - 106, 116 - 119, 128 - 130	Schraubnippel	145
O-Ringe HNBR	200	Schutzkappen	151
O-Ringheber-Satz	131	Sechskantmuttern	181
		Selbstschlussnippel	254
Pebra-Schnecken-gewindeschellen	166 - 168	Sicherungsbügel für Winkelgelenke	180
Perrot-Kupplungen	316	Sieb-nippel	255
P-Kabelbinder	174	Silikon-Gewebes-schlauch	37
PL-Schlauch	30	Silikon-Schlauch	38
Polyamidrohr	84, 85	S-Kabelbinder	175, 176
Polyamidrohr, fettgefüllt	144	SMS-Kupplungen	296, 297
Polyamidrohrnippel BE	89	Sortimente	206 - 219
Polymidrohrverbinder	90, 91	Spannschlüssel Storz/Guillemin	320
Polyamidrohr-Werkzeug	86	Spannstifte	266
Polyurethan-Schlauch	37	Splinte für Gabelgelenkbolzen	184
Presshülsen	194, 265	Spritzdüsen	239
Press-Verbinder	201, 202	S-Schlauch	18
		S-Schlauchschellen	162, 163
		Stapelbox, 3-fach	220

Stapelbox, 5-fach	220
Steck-Schwenkverschraubungen	137
Steckverbinder	93 - 96, 142, 143
Stopfen	278
Storz-Kupplungen	304 - 306

T ankwagen-Kupplungen	276, 277
T-Muffen	324, 326
TORRO S-Schneckengewindeschellen	165
TORRO-Schneckengewindeschellen	164
Trichterschmiernippel	152
Trix-Blaustrahl	41
TRIX-MULTIFOOD	48
Trix-Rotstrahl	43
TUBANO-Schlauch	34
TUBANO-Schlauchsortiment	34
T-Verschraubungen	138
TX-Schneckengewindeschellen	166

Ü bergangsstutzen	67
Überwurfmuttern	51, 52, 55, 87, 89, 139, 252
Überwurfschrauben	134
UNITRIX 60	46
UNITRIX 80	47
Unterdruckschlauch	18
U-Seal-Dichtringe	101

V entil-Anschlussstücke	191
Ventil-Einsätze	201
Verbinder-Sätze für Polyamidrohr	92
Verschlusskappen f. Serviceanschluss 134a	199
Verschlusskupplungen	224, 231, 237, 244
Verschlusschrauben	69, 70, 136, 186 - 189
Verschraubungen mit Sicherheitsbund	252
Verstärkungshülsen	91
Verteilerblöcke	141, 142

W asserschlauch	42
Winkelgelenke	178, 179
Winkelstücke	148, 149

Z ink-Dichtringe	101
-------------------------	-----



HSN HYDRAULIK 
 **SERVICE NORD**

Am Hafen 87 – 25421 Pinneberg
Telefon +49 4101 525 428 – Telefax +49 4101 525 429
E-Mail: info@hsnord.de – Internet: www.hsnord.de